

Specification

Part No. : **GGBLA.01.A**

Product Name : Unifier GPS/GLONASS/GALILEO/BEIDOU
Ceramic SMD Antenna

Feature : 3.2*1.6*0.5mm
Low profile Ceramic Loop antenna
Omnidirectional
RoHS Compliant

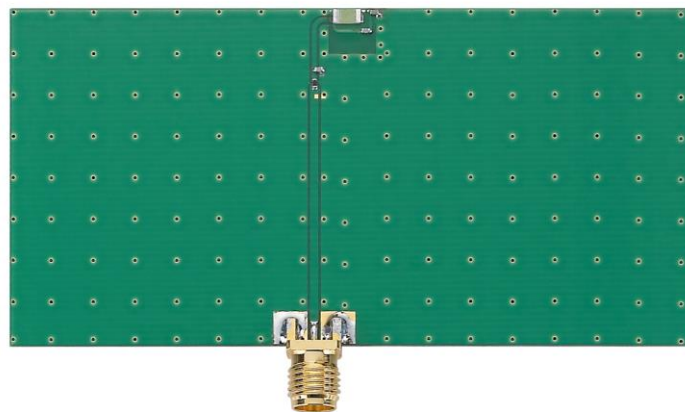

1. Introduction

Taoglas have developed a unique ceramic miniature loop antenna series for GPS-GLONASS-GALILEO-BEIDOU applications. At 3.2*1.6*0.5mm, the Unifier GGBLA.01.A Loop antenna is a miniature edge mounted SMD antenna, designed for small space requirements. Typical applications are small sized automotive navigation or position tracking systems and hand-held devices when GNSS function is needed. The radiation pattern is more omnidirectional than traditional patch antennas. The Unifier antenna series wide bandwidth allows high efficiency, stable reception on all three GPS, GLONASS and BeiDou bands from 1555MHz to 1602MHz.

Efficiencies of 64% to 85% are achievable. Peak gain of 3.3dBi places this antenna gain performance within the range of a much larger 15mm to 18mm patch antennas. Based on the loop effect this antenna works best when placed on the center of the edge of the board, but can still work better than traditional linear polarized chip antennas even when placed at corners as substitute.

The Unifier GGBLA.01.A is delivered on tape and reel and now allows M2M customers to use an omnidirectional antenna in devices where orientation of the product is unknown. Like all small antennas, care must be taken to ensure the device ground-plane layout and antenna matching has been done correctly, Taoglas offers professional Gerber review, transmission line design, general integration support and final matching service of the GGBLA.01.A on your device board at our regional labs worldwide. Contact your regional Taoglas sales office for immediate support.

2. Specification

ELECTRICAL GPS/GALILEO BAND	
Working Frequency*	1575.42MHz
VSWR	2.0 : 1 max
Polarization	Linear
Gain	Peak gain: 3.2 Typ.
Impedance	50 Ω
ELECTRICAL GLONASS BAND	
Working Frequency*	1598~1608MHz
VSWR	2.0 : 1 max
Polarization	Linear
Gain	Peak gain: 2.6 Typ.
Impedance	50 Ω
ELECTRICAL COMPASS-BEIDOU BAND	
Working Frequency*	1561 MHz
VSWR	2.0 : 1 max
Polarization	Linear
Gain	Peak gain: 2.8 Typ.
Impedance	50 Ω
MECHANICAL	
Dimensions	3.2 x 1.6 x 0.5 mm
Material	Ceramic
ENVIRONMENTAL	
Operation Temperature	-40°C to 85°C
Storage Temperature	-40°C to 105°C
Humidity	20% to 70%

* Measured on a 80*40mm ground plane

3. Antenna Characteristics

3.1. Return Loss

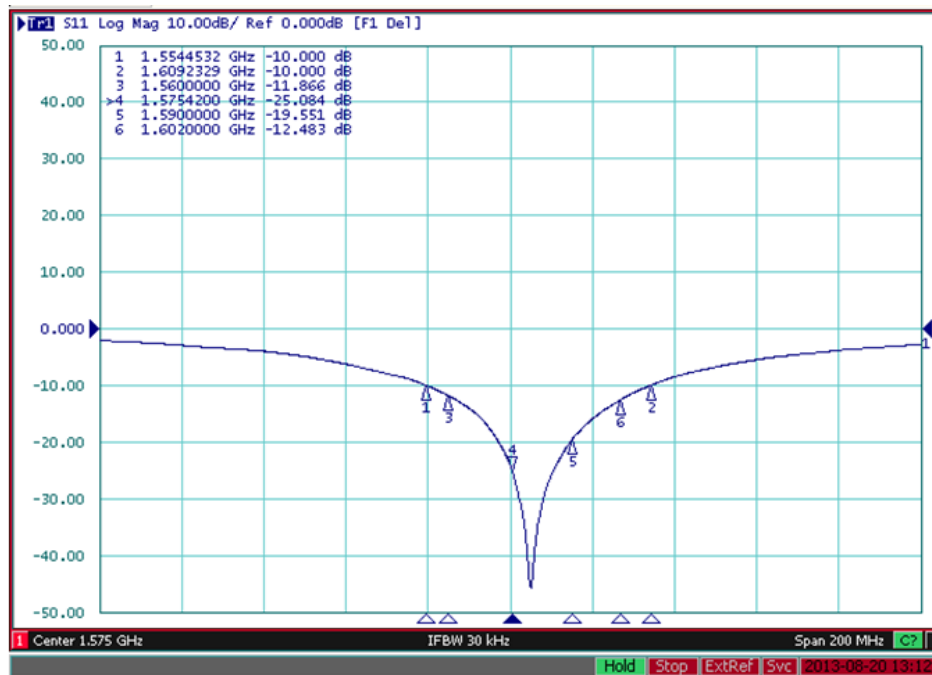

3.2. VSWR

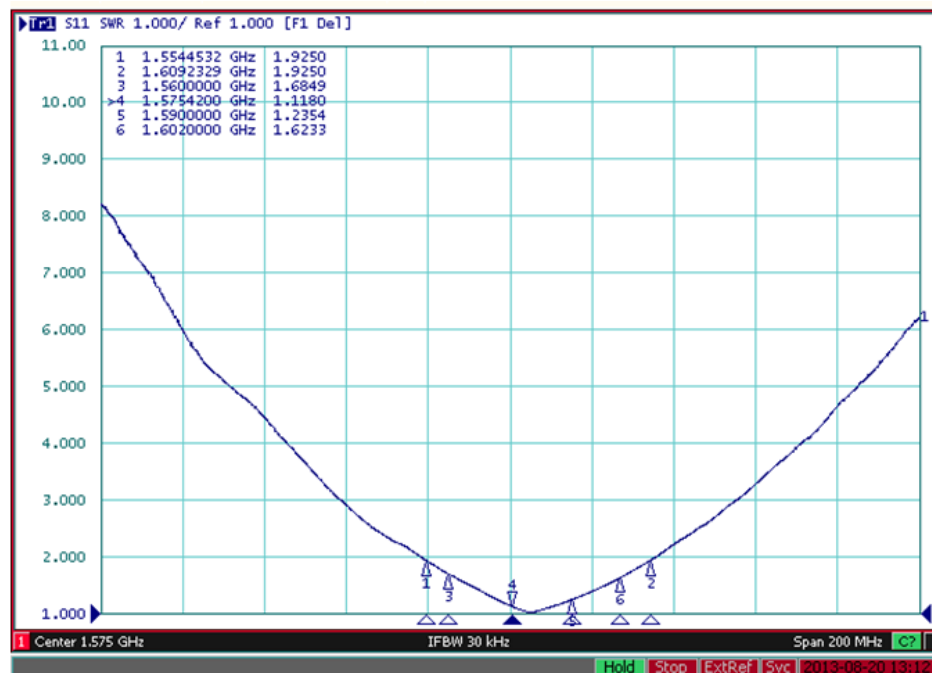

3.3. Efficiency

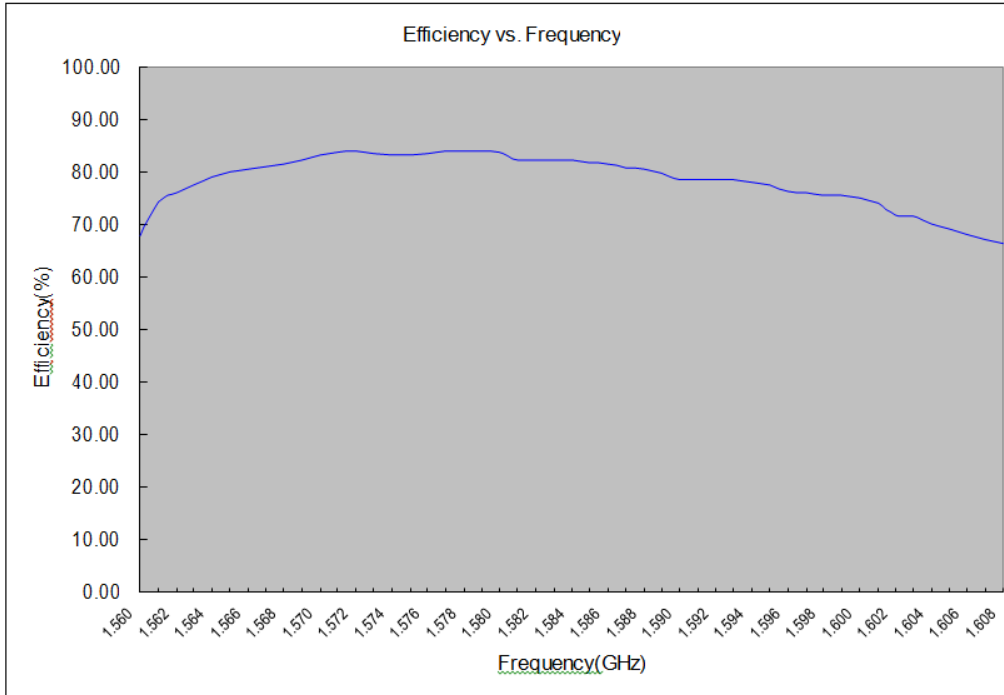

3.4. Efficiency and Gain Table

Frequency (MHz)	1560	1561	1562	1563	1564	1565	1566
Efficiency (dB)	-1.68	-1.29	1.18	-1.10	-1.02	-0.97	-0.94
Efficiency (%)	67.93	74.32	76.22	77.64	79.09	80.00	80.56
Gain (dBi)	2.82	2.90	2.99	3.05	3.10	3.14	3.17

Frequency (MHz)	1567	1568	1569	1570	1571	1572	1573
Efficiency (dB)	-0.91	-0.88	-0.85	-0.79	-0.77	-0.76	-0.78
Efficiency (%)	81.11	81.67	82.24	83.38	83.77	83.96	83.58
Gain (dBi)	3.20	3.21	3.24	3.29	3.29	3.30	3.28

Frequency (MHz)	1574	1575	1576	1577	1578	1579	1580
Efficiency (dB)	-0.79	-0.79	-0.78	-0.76	-0.76	-0.75	-0.77
Efficiency (%)	83.38	83.43	83.58	83.96	83.96	84.16	83.77
Gain (dBi)	3.29	3.29	3.29	3.29	3.29	3.28	3.26

Frequency (MHz)	1581	1582	1583	1584	1585	1586	1587
Efficiency (dB)	-0.84	-0.84	-0.85	-0.85	-0.87	-0.89	-0.93
Efficiency (%)	82.36	82.43	82.24	82.24	81.86	81.49	80.74
Gain (dBi)	3.16	3.17	3.14	3.12	3.11	3.08	3.05

Frequency (MHz)	1588	1589	1590	1591	1592	1593	1594
Efficiency (dB)	-0.94	-0.98	-1.05	-1.04	-1.04	-1.04	-1.07
Efficiency (%)	80.55	79.82	78.54	78.72	78.72	78.72	78.18
Gain (dBi)	3.03	2.99	2.93	2.93	2.93	2.90	2.88

Frequency (MHz)	1595	1596	1597	1598	1599	1600	1601
Efficiency (dB)	-1.10	-1.17	-1.19	-1.21	-1.21	-1.24	-1.30
Efficiency (%)	77.64	76.43	76.05	75.70	75.70	75.18	74.14
Gain (dBi)	2.84	2.82	2.77	2.75	2.74	2.71	2.66

Frequency (MHz)	1602	1603	1604	1605	1606	1607	1608
Efficiency (dB)	-1.65	-1.45	-1.54	-1.60	-1.67	-1.73	-1.78
Efficiency (%)	71.98	71.63	70.16	69.20	68.09	67.16	66.39
Gain (dBi)	2.58	2.54	2.46	2.41	2.36	2.31	2.28

4. 3D Antenna Radiation Pattern

4.1. BeiDou 1560MHz (80*40mm Ground Plane)

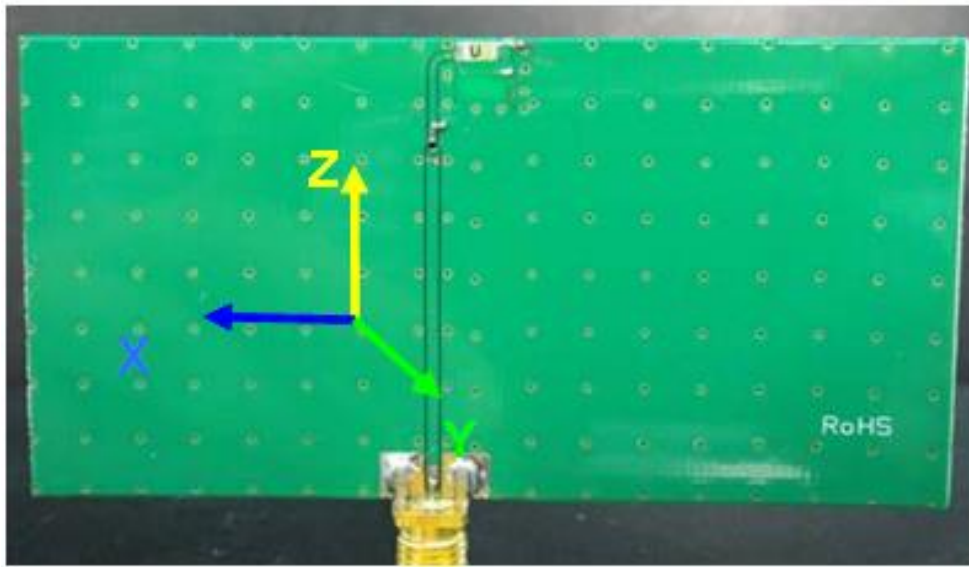

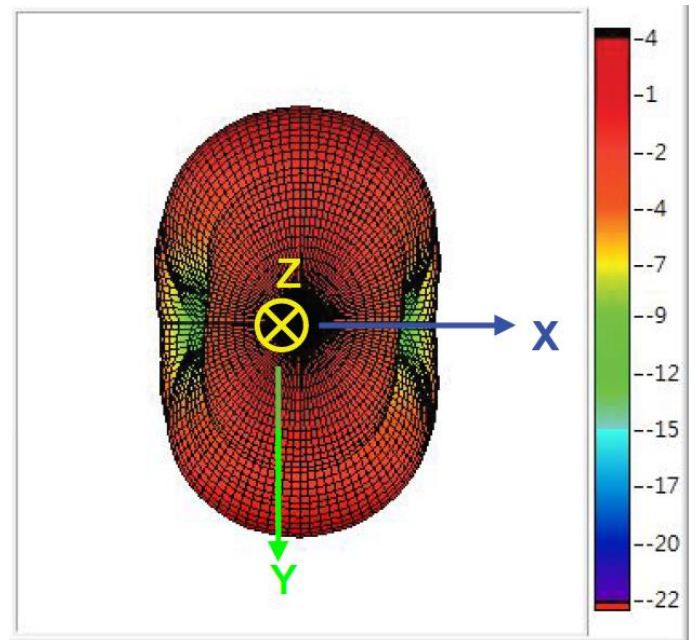
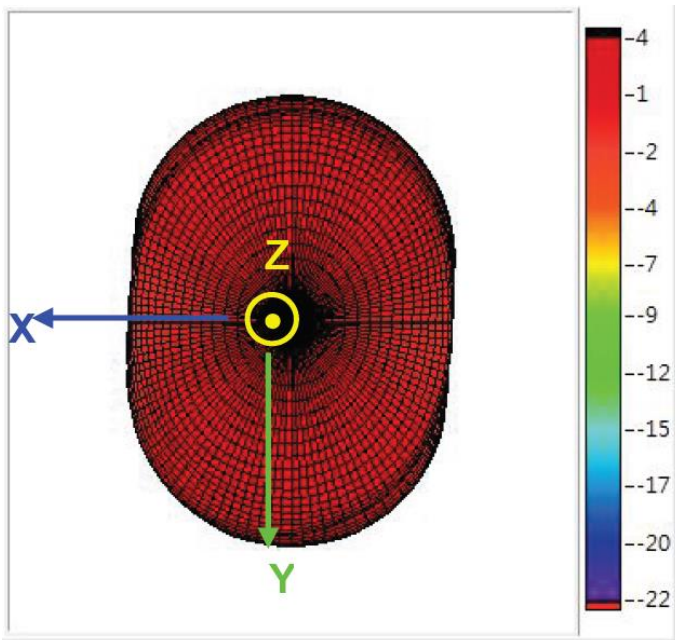
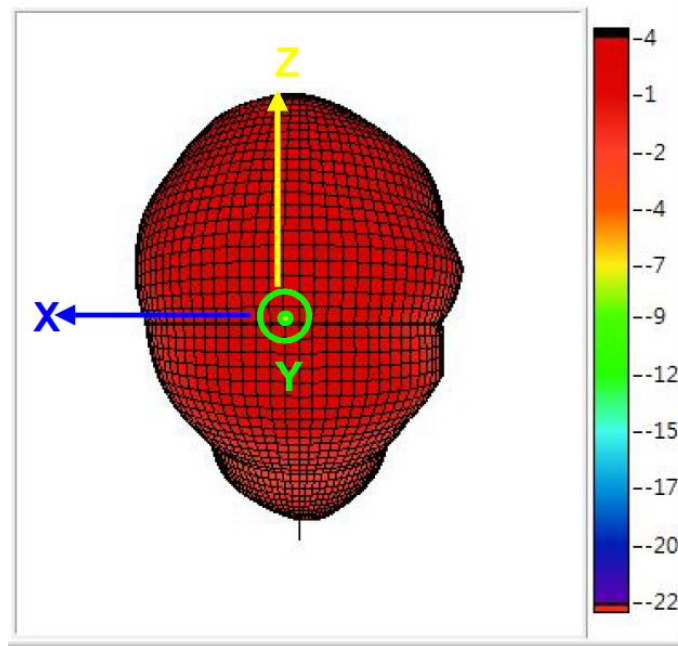

4.2. GPS/GALILEO 1575MHz (80*40mm Ground Plane)

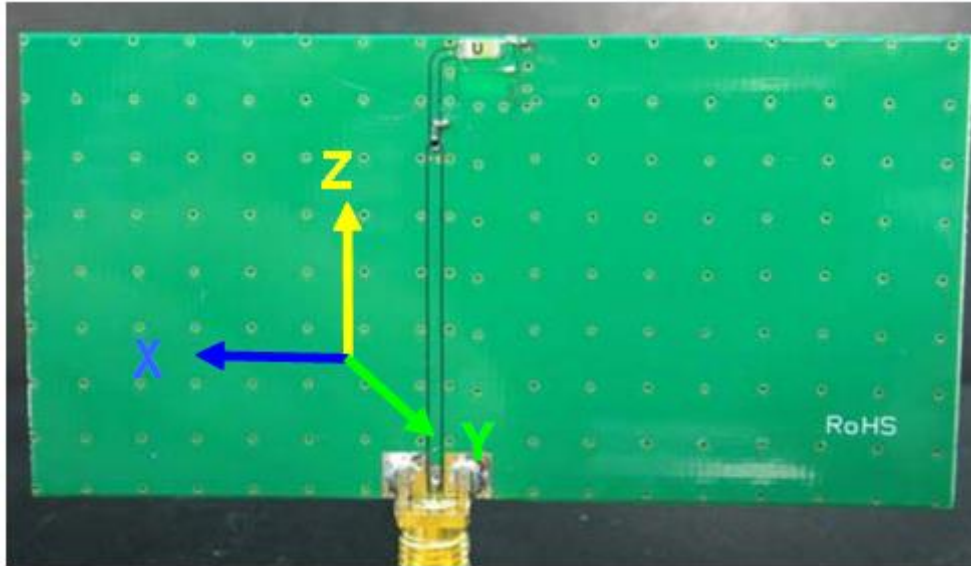

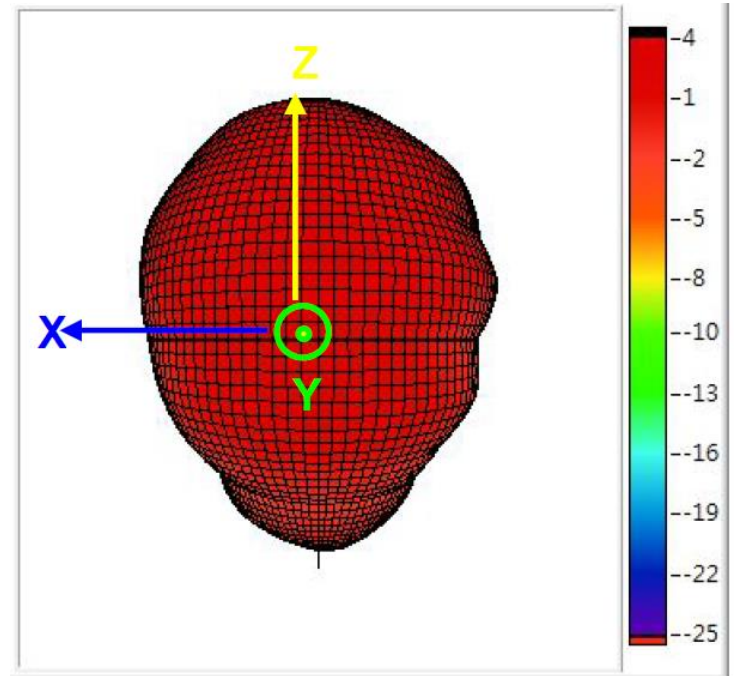
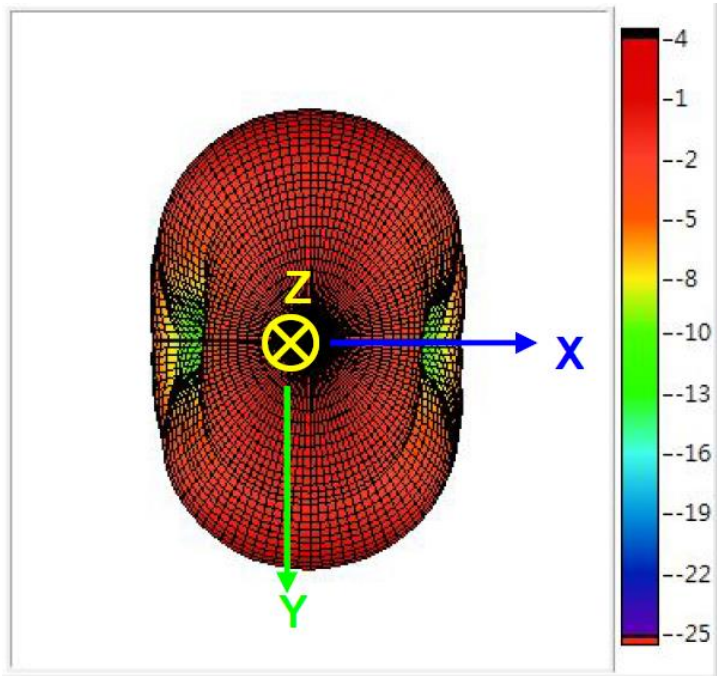
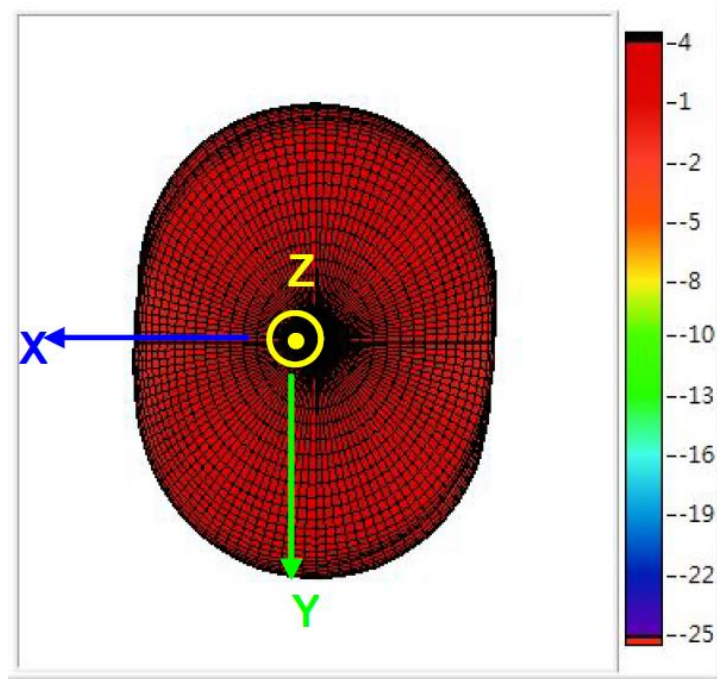

4.3. GLONASS 1602MHz (80*40mm Ground Plane)

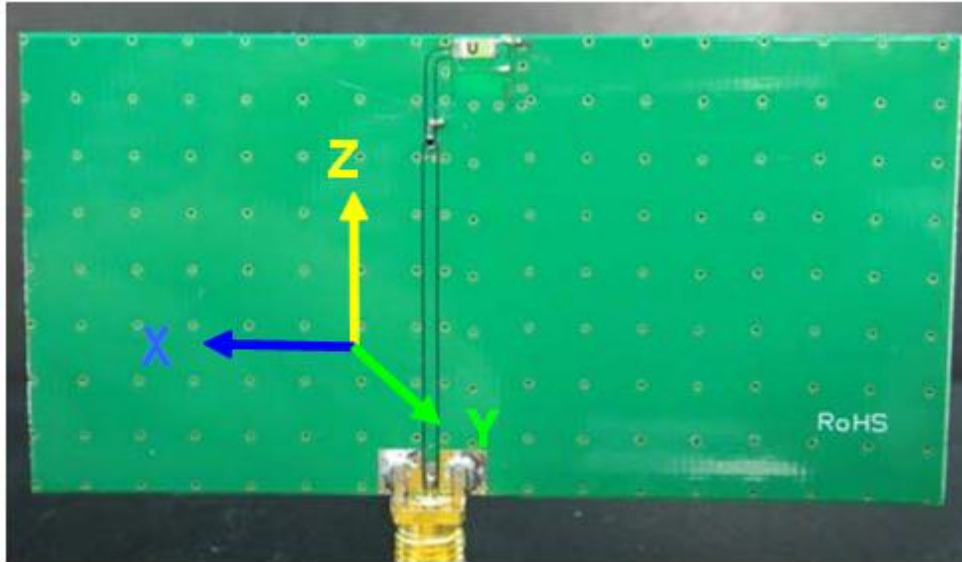

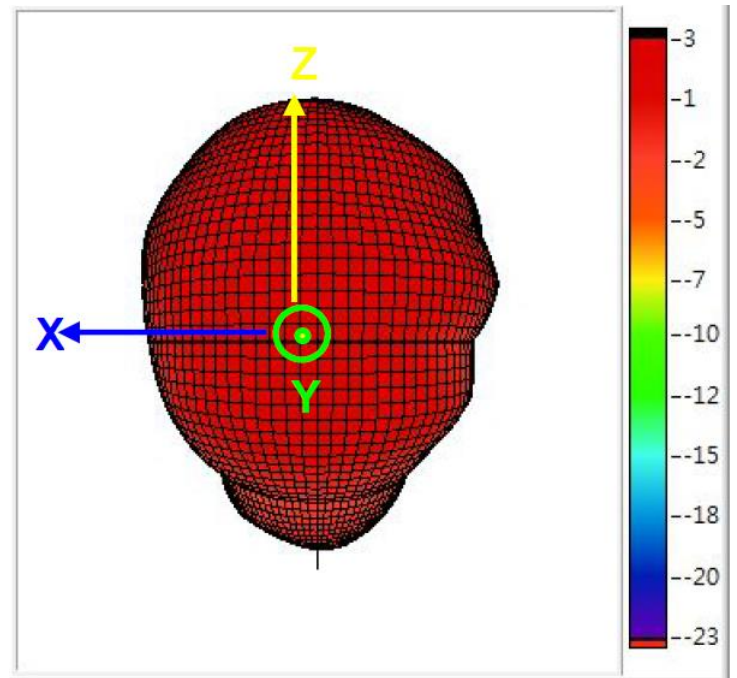
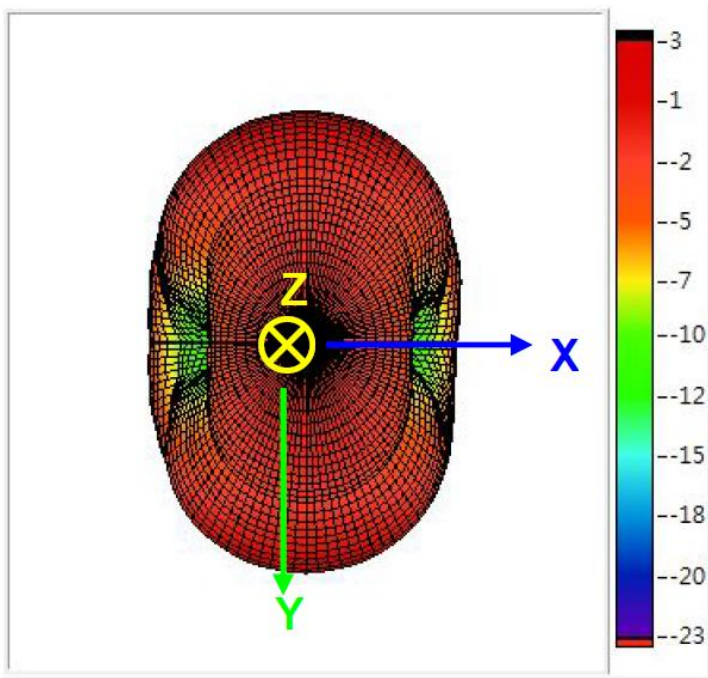
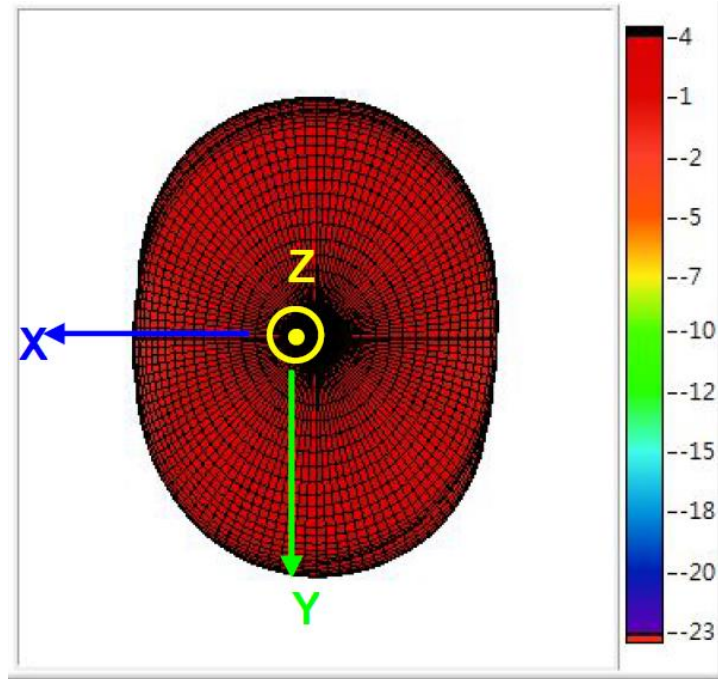

5. Mechanical Drawing (Unit: mm)

5.1. Drawing EVB

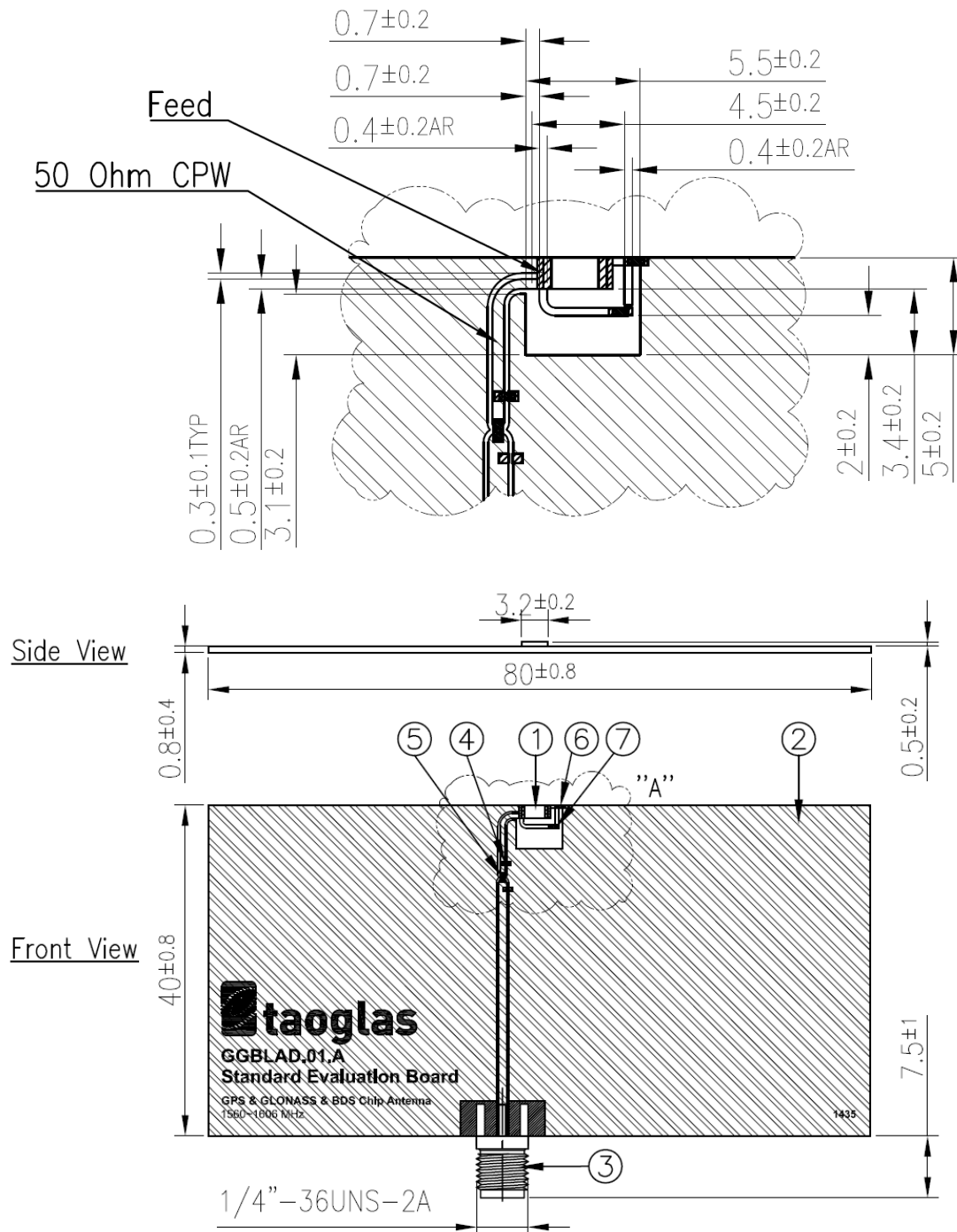

5.2. Antenna Drawings

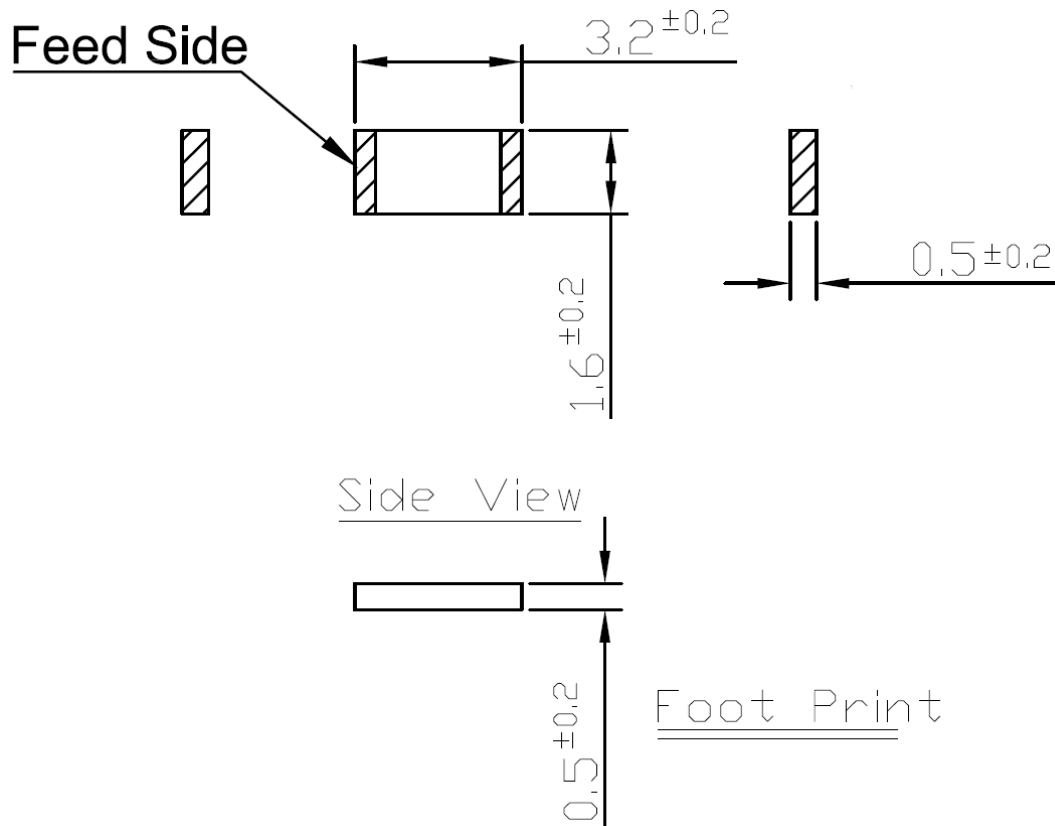

	Name	Material	Finish	QTY
1	GGBLA.01.A Antenna	Ceramic	N/A	1
2	GGBLAD.01.A EVB Board	Composite 0.8t	Black	1
3	SMA(F) ST	Brass	Au Plated	1
4	Capacitor 0.8pF (0402)	Ceramic	N/A	1
5	Capacitor 2.7pF (0402)	Ceramic	N/A	1
6	Capacitor 22pF (0402)	Ceramic	N/A	1
7	Capacitor 0.5pF (0402)	Ceramic	N/A	1

NOTES:

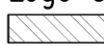
1. Solder Area 
2. Logo & Text Ink Printing : White
3.  Copper
4.  Matching Component

6. Layout Guide

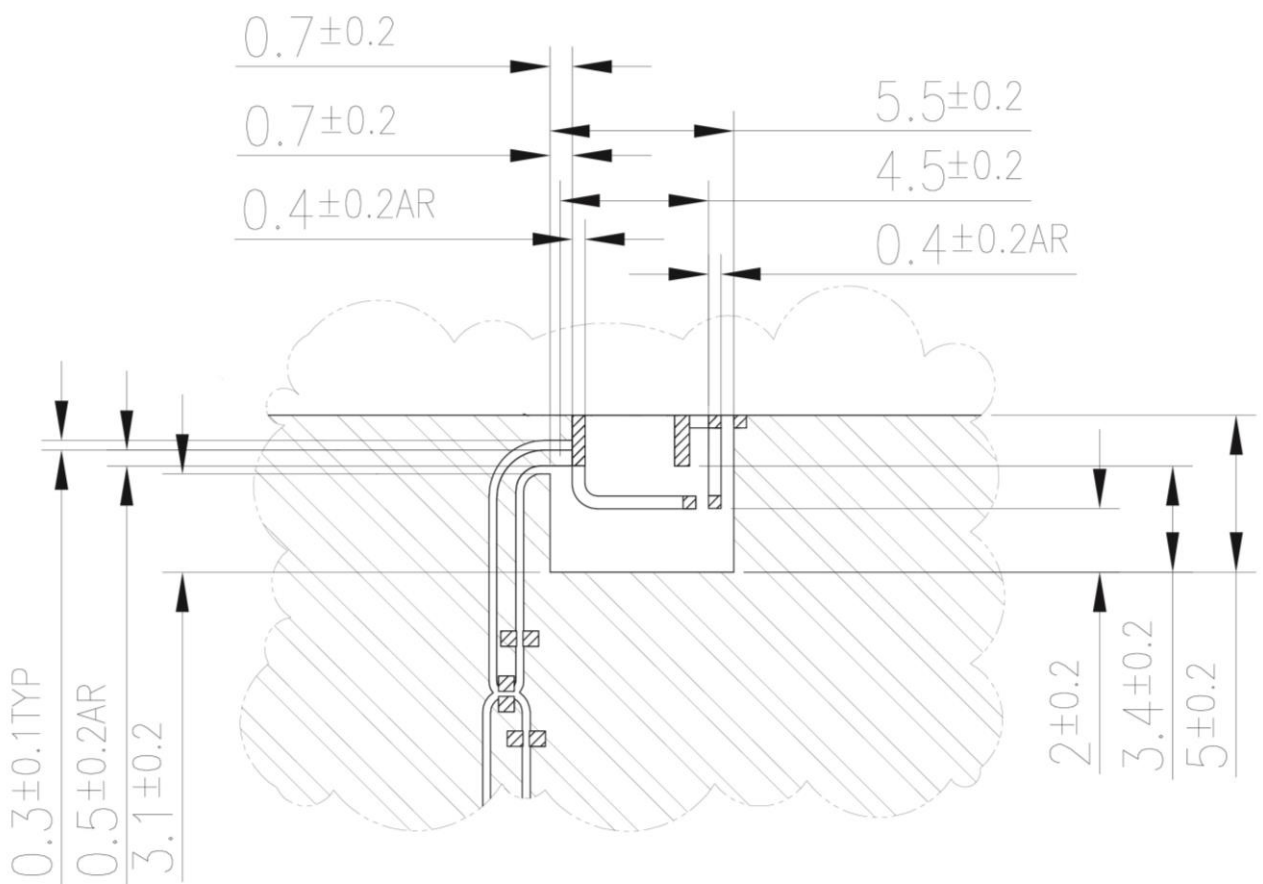

7. Frequency tuning

7.1. Antenna tuning

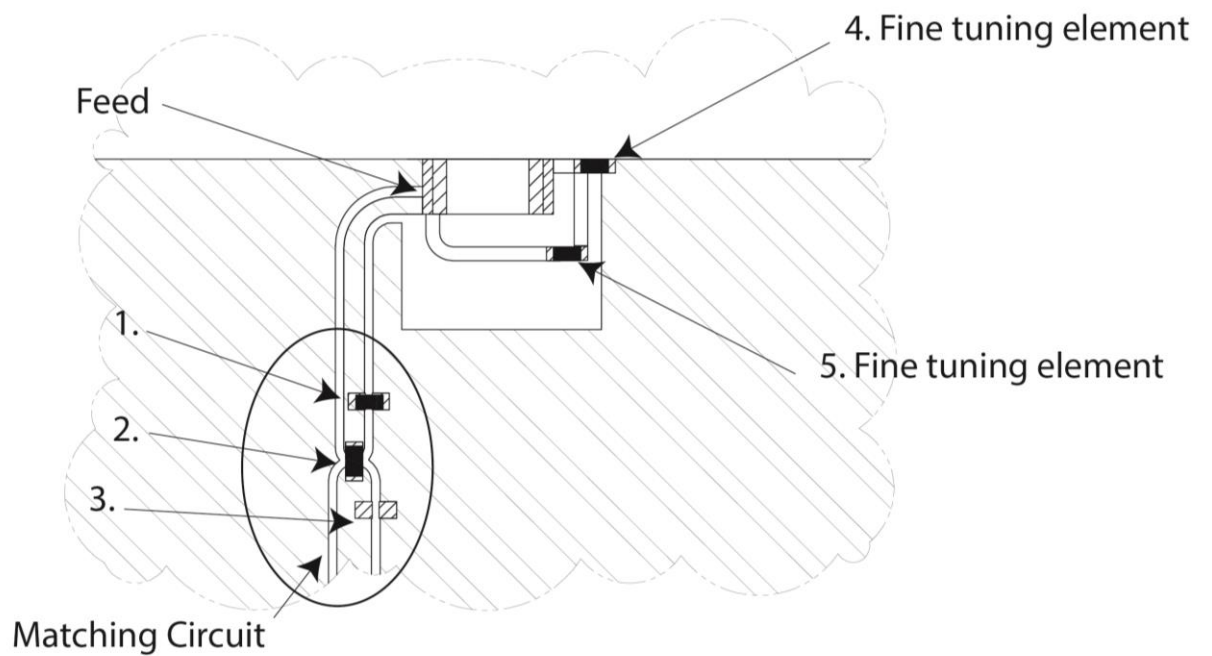

7.2. Matching Circuit (center frequency 1575.42Mhz @ 80*40mm Ground)

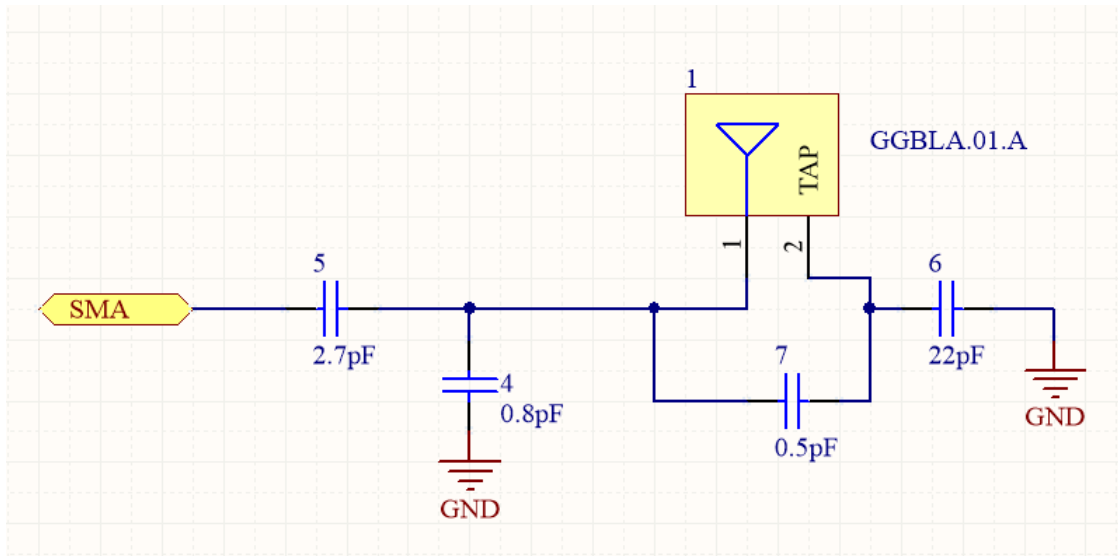

System Matching Circuit Component			
Location	Description	Vendor	Tolerance
1	0.8 pF	DARFON (0402)	±0.1pF
2	2.7 pF	DARFON (0402)	±0.1pF
3	N/A	-	-
Fine Tuning Element 4	22 pF	DARFON (0402)	±0.1pF
Fine Tuning Element 5	0.5 pF	DARFON (0402)	±0.1pF

7.3. Fine tuning element vs. Center Frequency

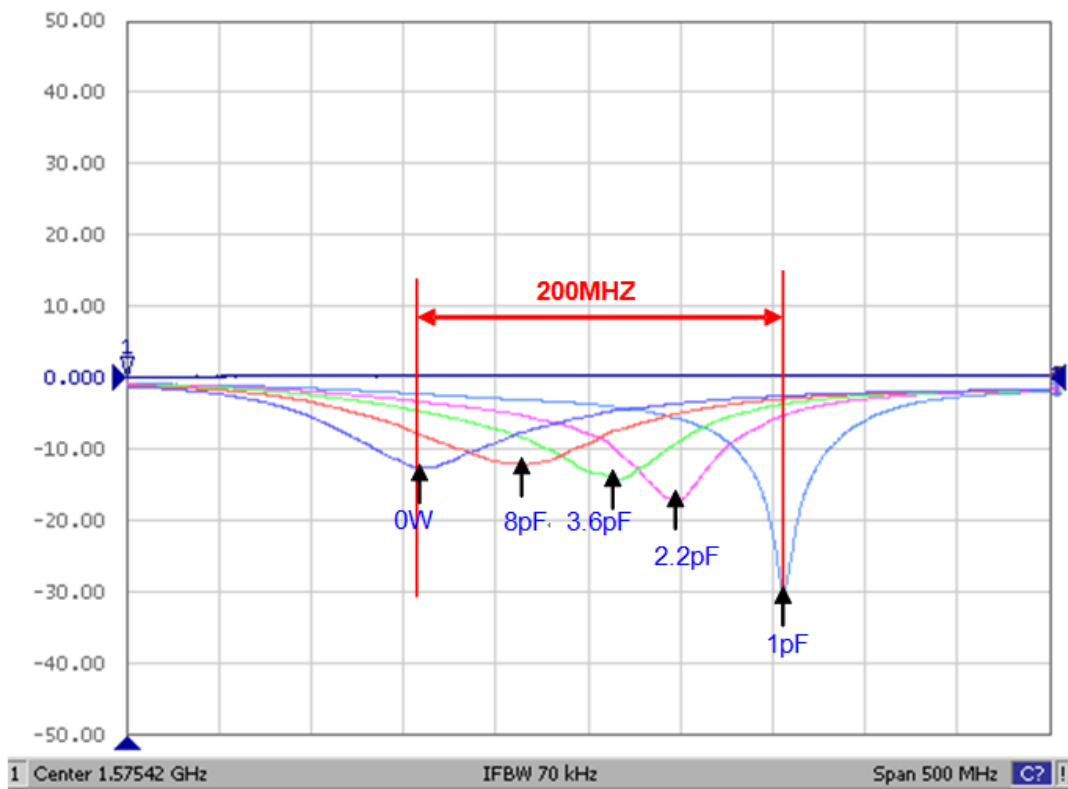

8. Recommended Reflow Profile

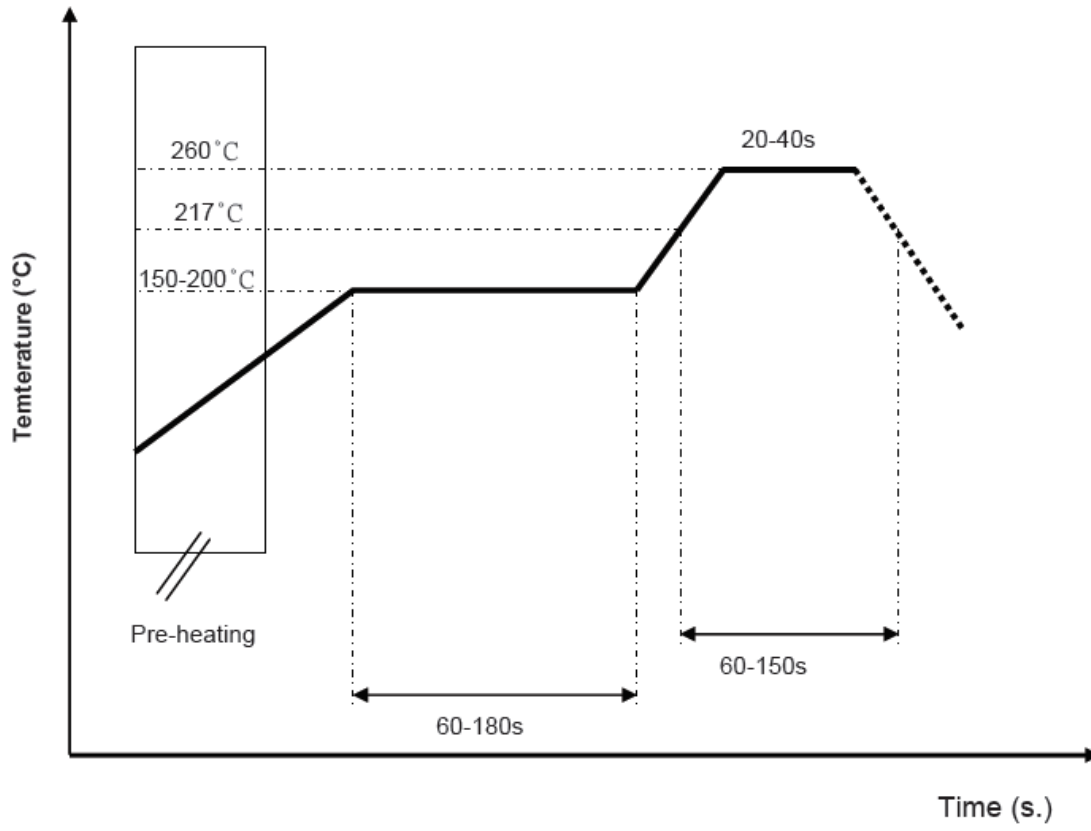

9. Packaging

6000 pc GGBLA.01.A per reel
Dimensions - Ø330*20mm
Weight - 700g

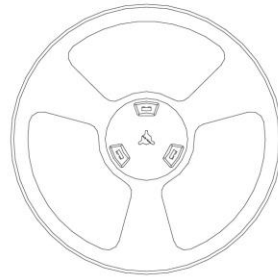

9 Reels / 5400 pcs in one carton
Carton Dimensions - 350*350*210mm
Weight - 5.6Kg

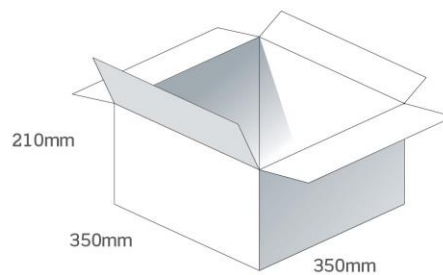

Pallet Dimensions 1200mm*1000mm*1460mm
36 Cartons per pallet
6 Cartons per layer
6 Layers

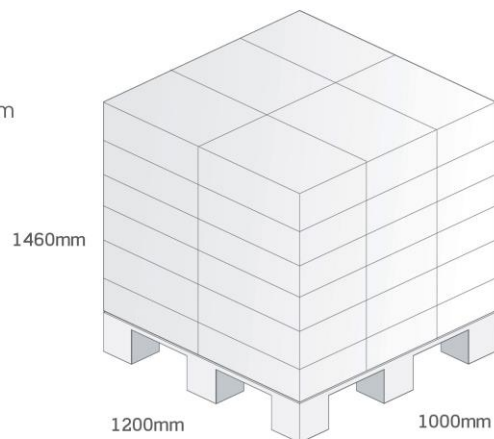

9.1. Reel Drawing

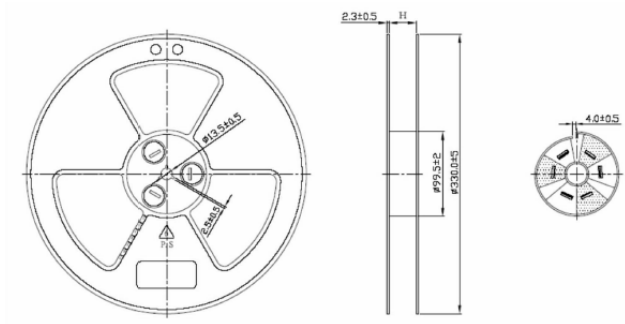

H 值	公差	備註
24.6 mm	±2 mm	適用料帶寬度 24mm
12.6 mm	±1 mm	適用料帶寬度 12mm

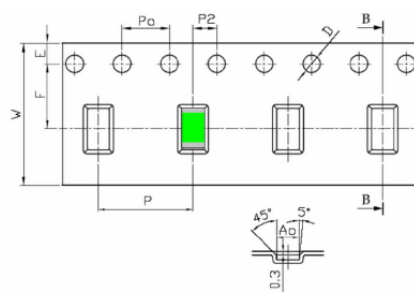

2.1 共同尺寸		
外觀	規格	公差
W	12.00	±0.30
P	8.00	±0.10
E	1.75	±0.10
F	5.50	±0.10
P2	2.00	±0.10
D	1.50	+0.08 -0.05
D1	-	±0.10
P0	4.00	±0.10
10P0	40.00	±0.20

2.2 口徑尺寸		
外觀	規格	公差
A0	1.90	+0.20 -0.10
B0	3.50	+0.10 -0.10
K0	0.60	+0.20 -0.10
t	0.30	±0.05

Taoglas makes no warranties based on the accuracy or completeness of the contents of this document and reserves the right to make changes to specifications and product descriptions at any time without notice. Taoglas reserves all rights to this document and the information contained herein.

Reproduction, use or disclosure to third parties without express permission is strictly prohibited.

Copyright © Taoglas Ltd.