

## **SPECIFICATION**

### **G21.W White Hercules Gen II Penta Band Cellular Antenna**

- Part No. : **G21.B.W.301111**
- Product Name : G21.W Hercules Gen.II Penta Band Cellular Antenna  
Screw-mount (Permanent mount)- White Version  
GSM/GPRS/CDMA/EVDO/UMTS/HSPA/WCDMA  
850/900/1800/1900/2100 MHz
- Features :
  - Low profile - Height 29mm and diameter 49mm
  - Heavy duty screw mount
  - UV and Vandal resistant White ABS housing
  - IP67 & IP69K – No ingress of dust and no water ingress permitted from powerful pressure jets in all directions and no performance degradation
  - Standard is 3M Cable RG174 SMA(M)-Customizable
  - **ROHS Compliant**



## 1. INTRODUCTION

The G21.W (Generation II) Hercules is a high performance steel thread-mount Penta-band cellular antenna for external use on vehicles and outdoor assets worldwide. Omni-directional high gain across all bands ensures constant reception and transmission. Durable UV resistant ABS housing is resistant to vandalism and direct attack. At only 29 mm height it complies with the latest EU height restrictions directives for roof-mounted objects, with a diameter of 49 mm. Designed to not catch on tree-branches. This antenna can be mounted on metal structures.

## 2. SPECIFICATION

ELECTRICAL CELLULAR						
Standard		AMPS	GSM	DCS	PCS	3G
Band (MHz)		850	900	1800	1900	2100
Frequency (MHz)		824-896	880-960	1710-1880	1850-1990	1920 -2170
Return Loss (dB)						
Cable length (meter)	0.3	-6.0	-5.2	-6.1	-6.2	-5.8
	1.0	-7.8	-8.7	-11.4	-15.3	-13.7
	2.0	-8.1	-9.3	-16.5	-20.3	-19.5
	3.0	-11.0	-12.4	-17.5	-18.3	-18.1
	5.0	-11.8	-13.6	-17.6	-17.8	-17.8
Efficiency (%)						
Cable length (meter)	0.3	51.1	41.4	38.0	46.5	32.3
	1.0	29.4	40.2	42.2	43.4	29.9
	2.0	24.3	27.5	28.4	20.2	19.6
	3.0	24.6	27.6	22.0	17.8	15.0
	5.0	17.1	16.4	15.7	15.0	12.0
Gain (dBi)						
Cable length (meter)	0.3	1.8	0.8	1.3	3.9	1.5
	1.0	1.0	2.2	0.6	1.6	-0.3
	2.0	0.9	1.8	0.2	-0.7	-1.1
	3.0	0.8	0.9	-1.0	-1.1	-2.2
	5.0	-1.0	-0.5	-4.5	-4.2	-4.3
Polarization				Linear		
Impedance				50 ohms		
Max Input Power				10 watts		
VSWR				<3.5:1		

\*Note: The return loss, efficiency and gain in the above table, were measured on 30x30 cm metal plate with RG174 cable. For a specific case performance refers to the below plots.

<b>MECHANICAL</b>	
Dimensions	Height = 29 mm and Diameter = 49mm
Cable	3M RG174 – Fully Customizable
Connector	SMA-Male – Fully Customizable
Casing	White UV Resistant ABS
Base and Thread	Nickel plated steel
Thread Diameter	18 mm
Weather proof gasket	CR4305 foam with 3M9448B double-side adhesive
Sealant	Rubber Stopper
<b>ENVIRONMENTAL</b>	
Protection	IP67 & IP69K
Corrosion	5% NaCl for 96hrs - Nickel plated steel base and thread
Temperature Range	-40°C to +85°C
Thermal Shock	100 cycles -40°C to +85°C
Humidity	Non-condensing 65°C 95% RH
Shock (Drop Test)	1m drop on concrete 6 axes
Cable Pull	8 Kgf
Recommended Mounting Torque	95Nm
Maximum Mounting Torque	135Nm

\*Note: Specifications may be subject to change

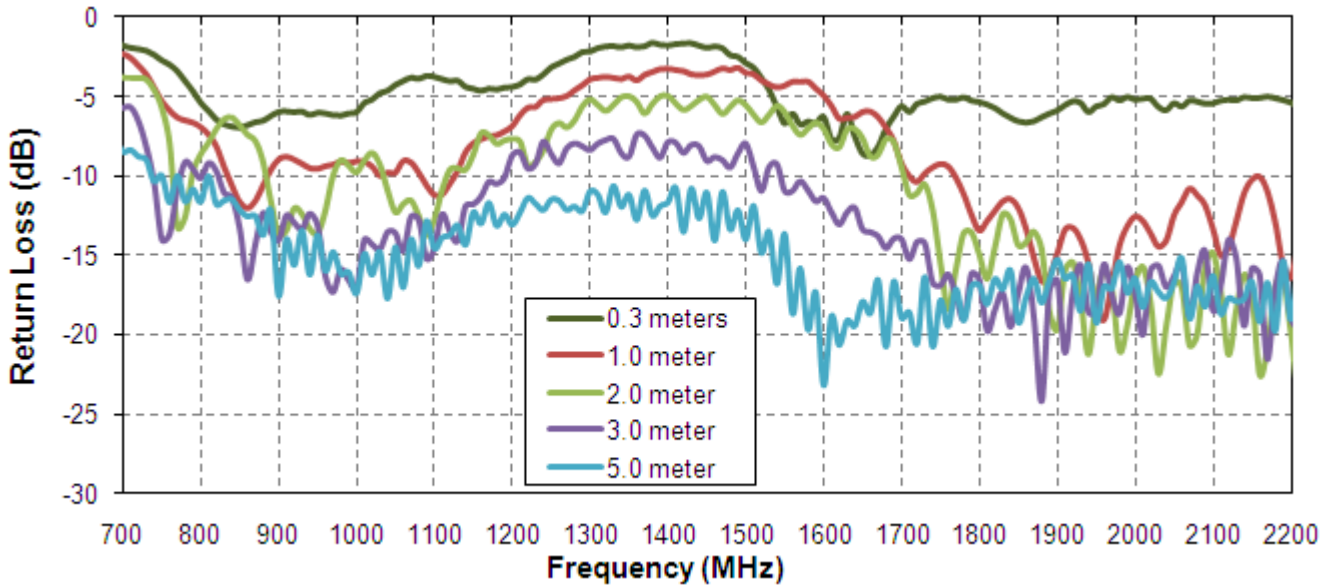
### 3. TEST SET UP



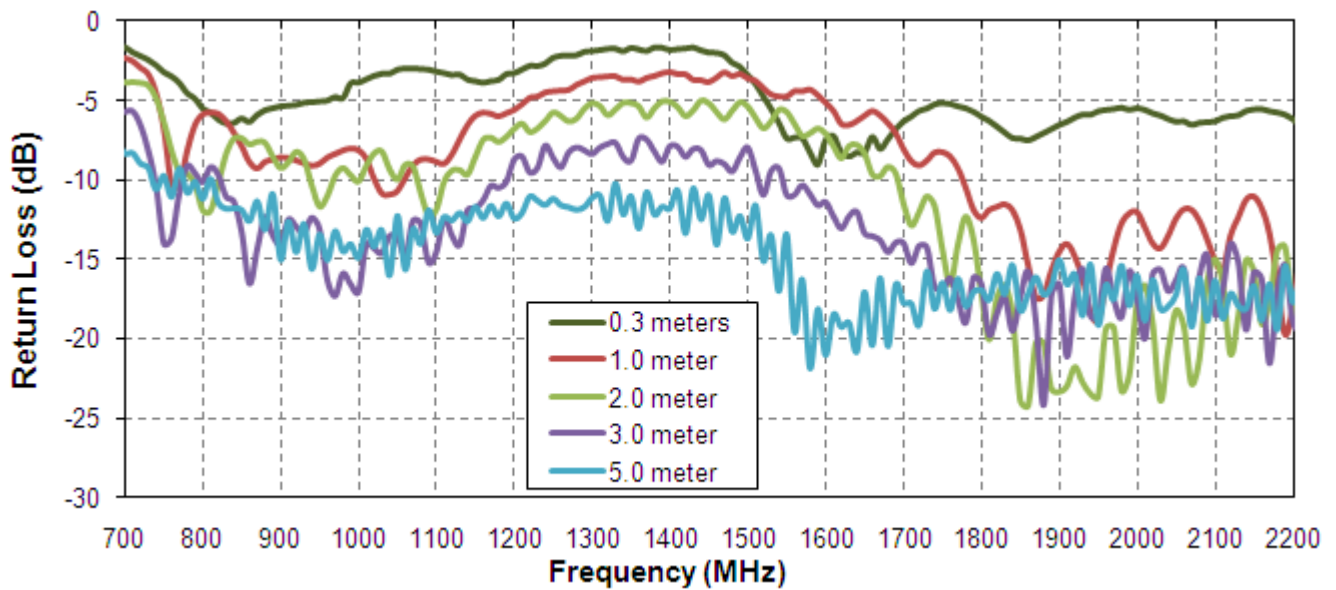
**Figure 1.** G21 Antenna test set up in free space, 30x30 cm metal plate and 60x60 cm metal plate, R&SZVL6 VNA (left) and R&S4100 CTIA 3D Chamber (Right).

## 4. ANTENNA PARAMETERS

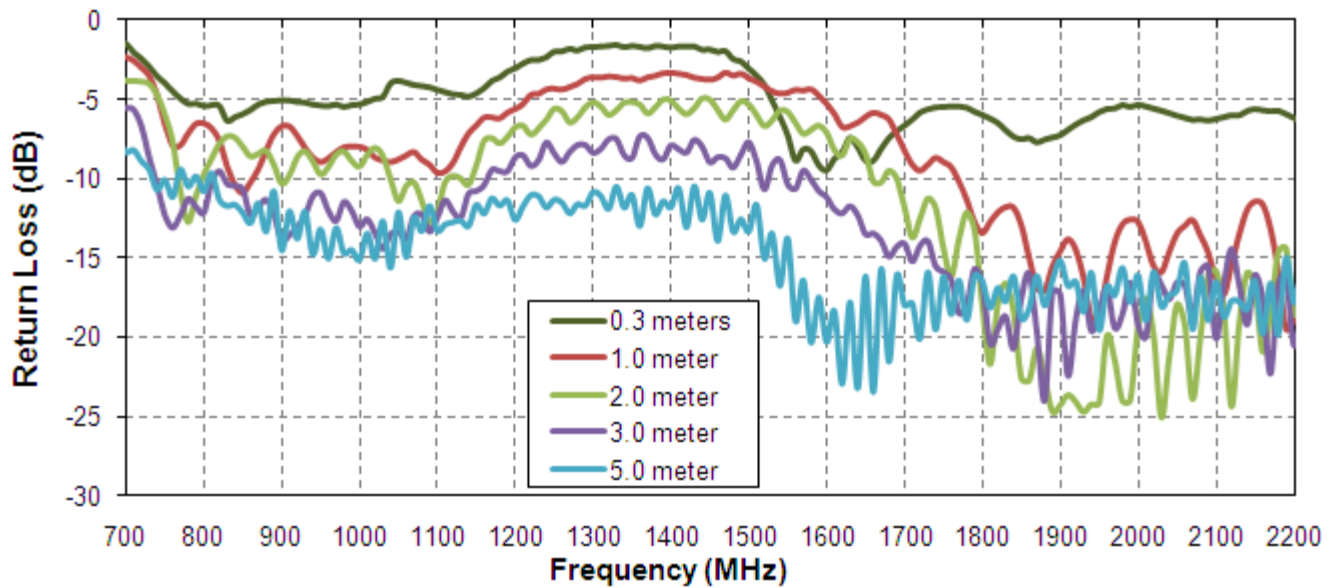
### 4.1 Return Loss



**Figure 2.** Return Loss of G21 Hercules antenna in free space

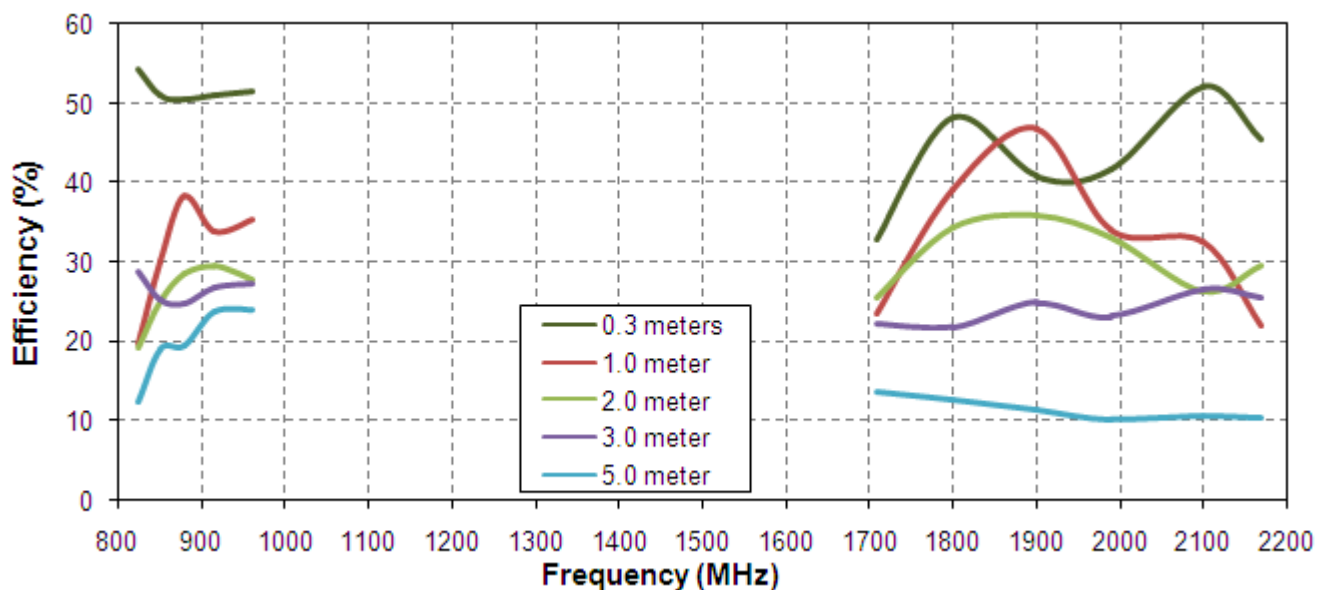


**Figure 3.** Return loss of G21 Hercules antenna on 30 cm metal plate.

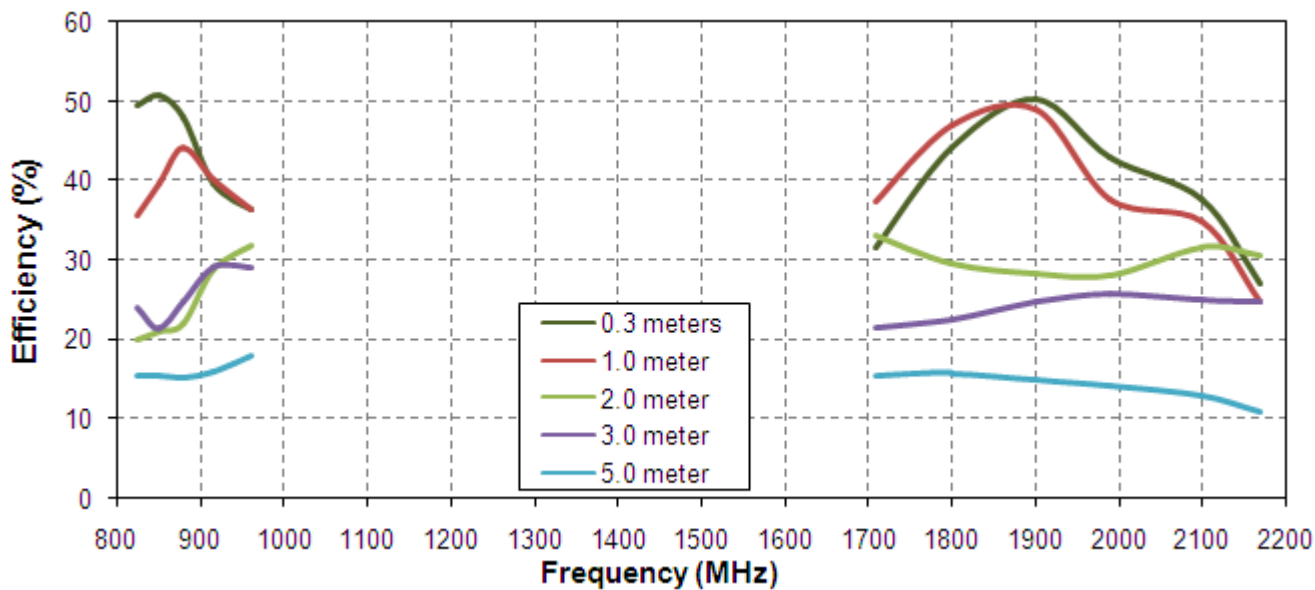


**Figure 4.** Return loss of G21 Hercules antenna on 60 cm metal plate.

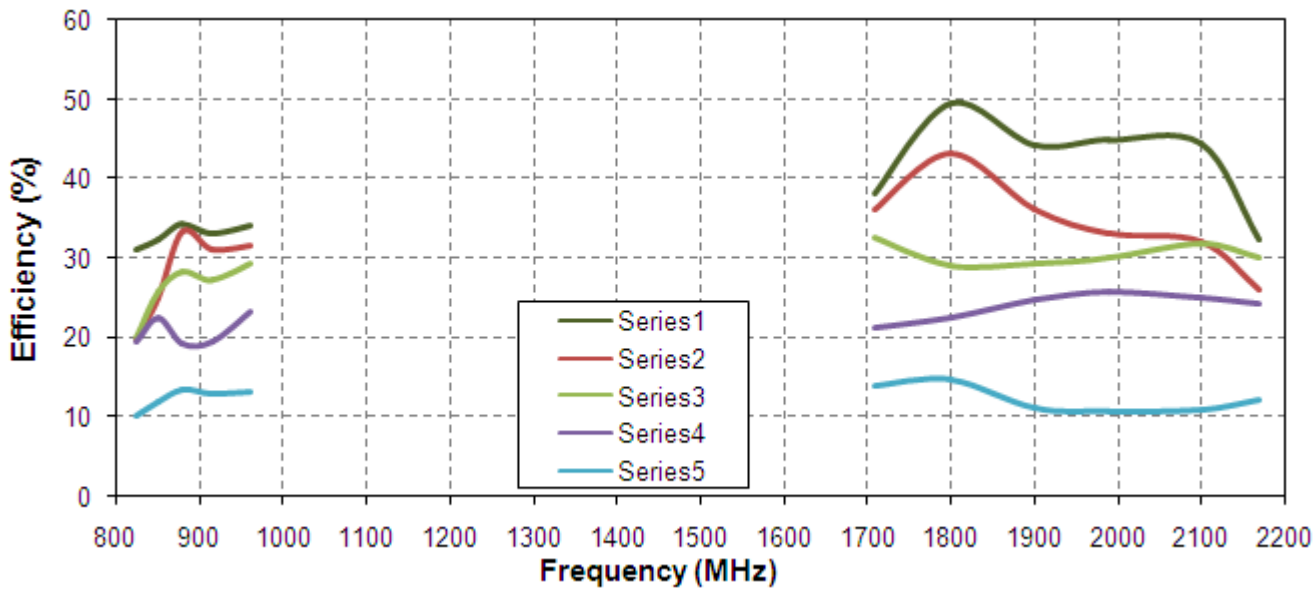
## 4.2 Efficiency



**Figure 5.** Efficiency of G21 Hercules antenna in free space



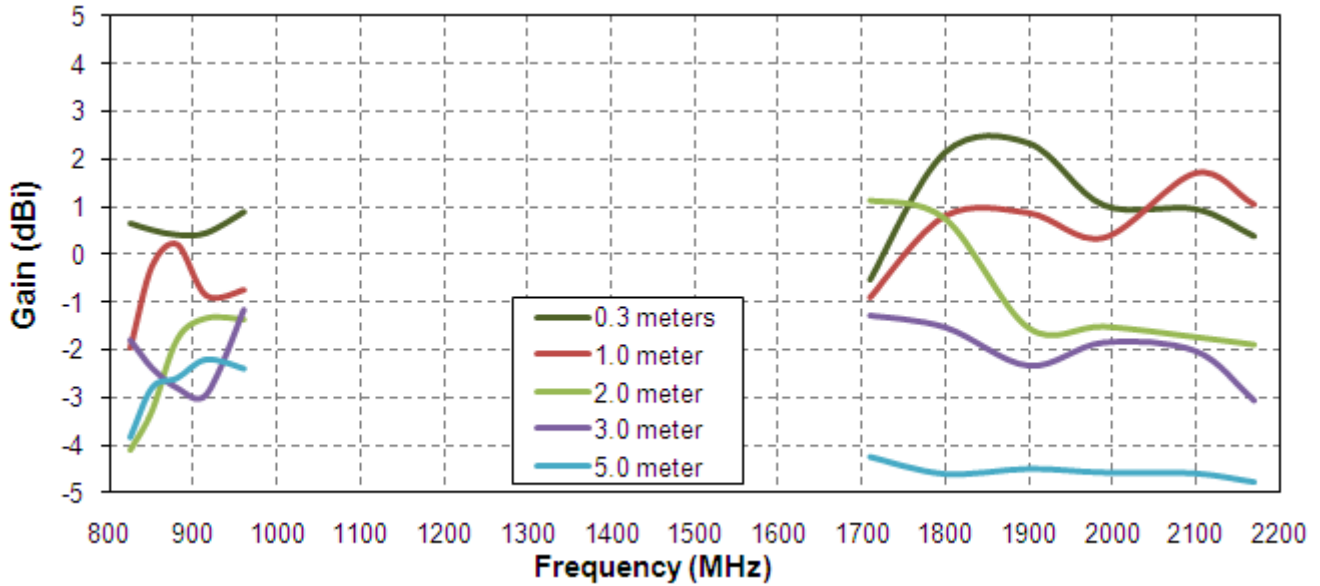
**Figure 6.** Efficiency of G21 Hercules antenna on 30 cm metal plate.



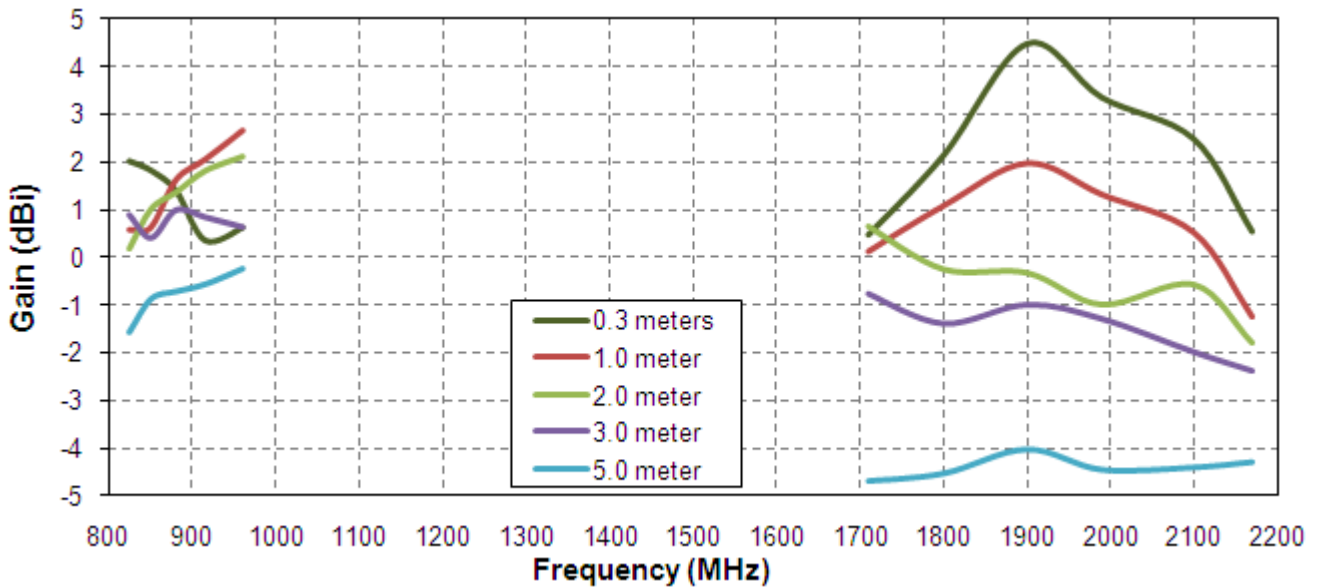
**Figure 7.** Efficiency of G21 Hercules antenna on 60 cm metal plate.



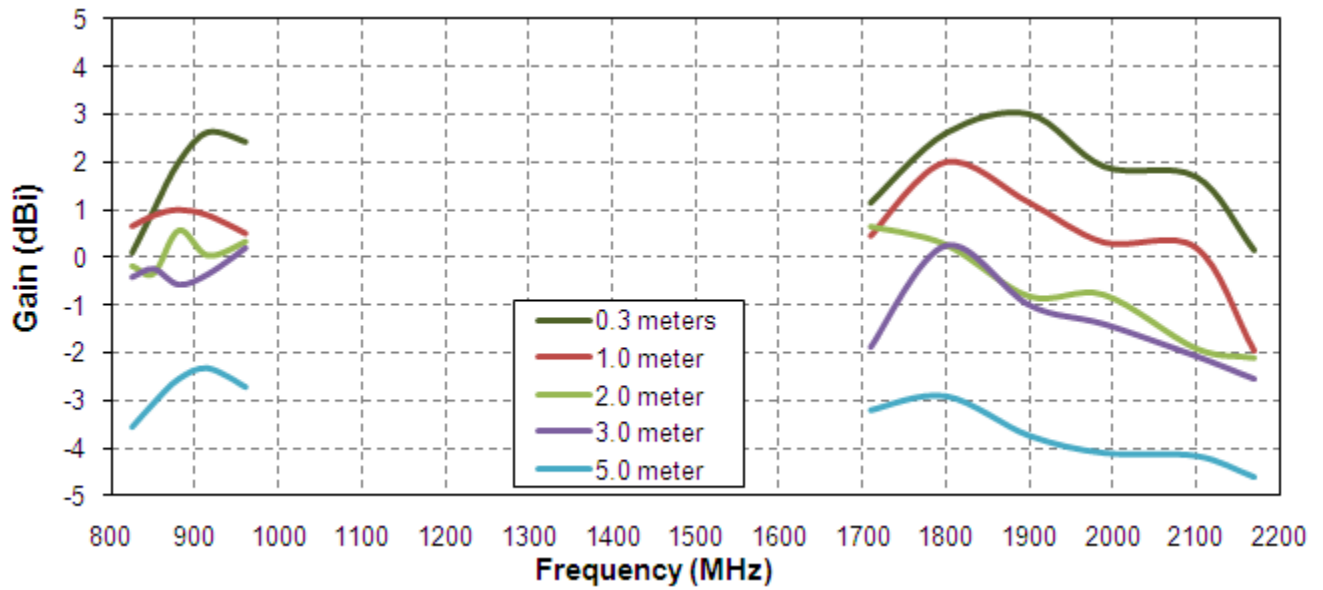
### 4.3 Gain



**Figure 8.** Gain of G21 Hercules antenna in free space.



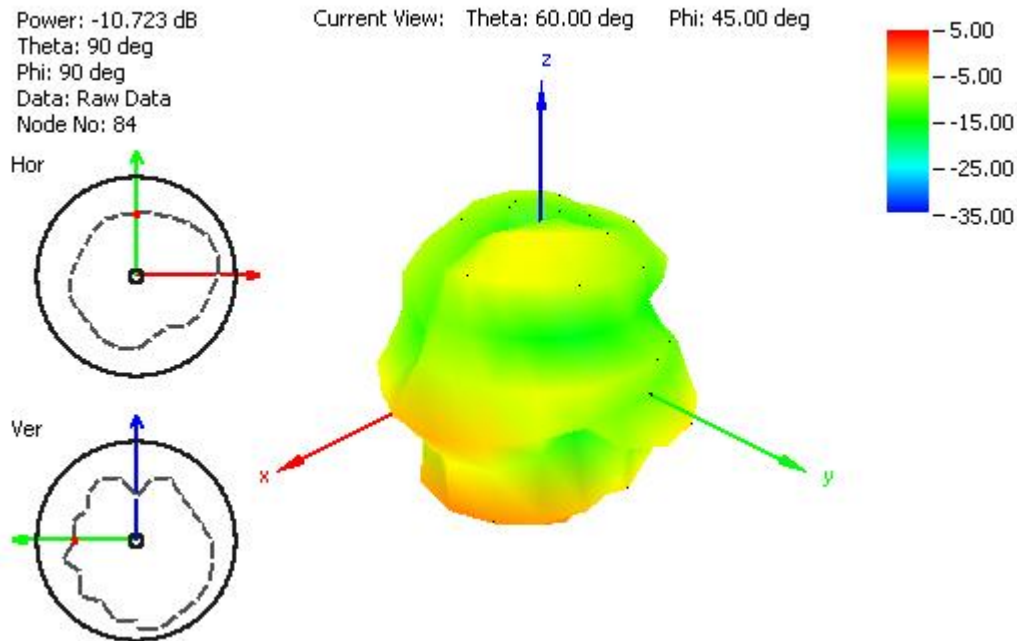
**Figure 9.** Gain of G21 Hercules antenna on 30 cm metal plate.



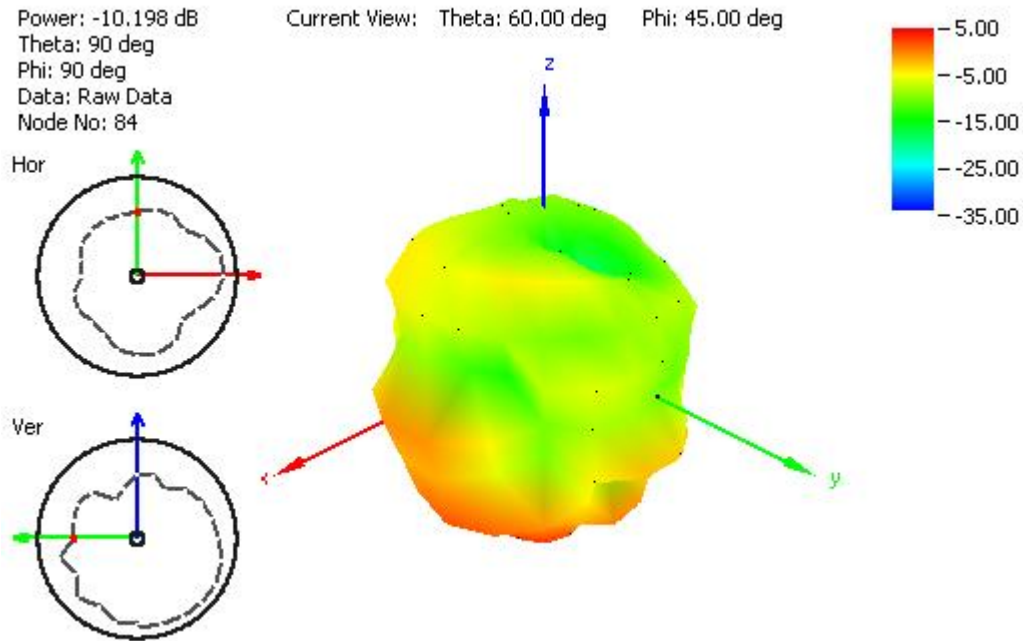
**Figure 10.** Gain of G21 Hercules antenna on 60 cm metal plate.

## 5. Radiation Pattern

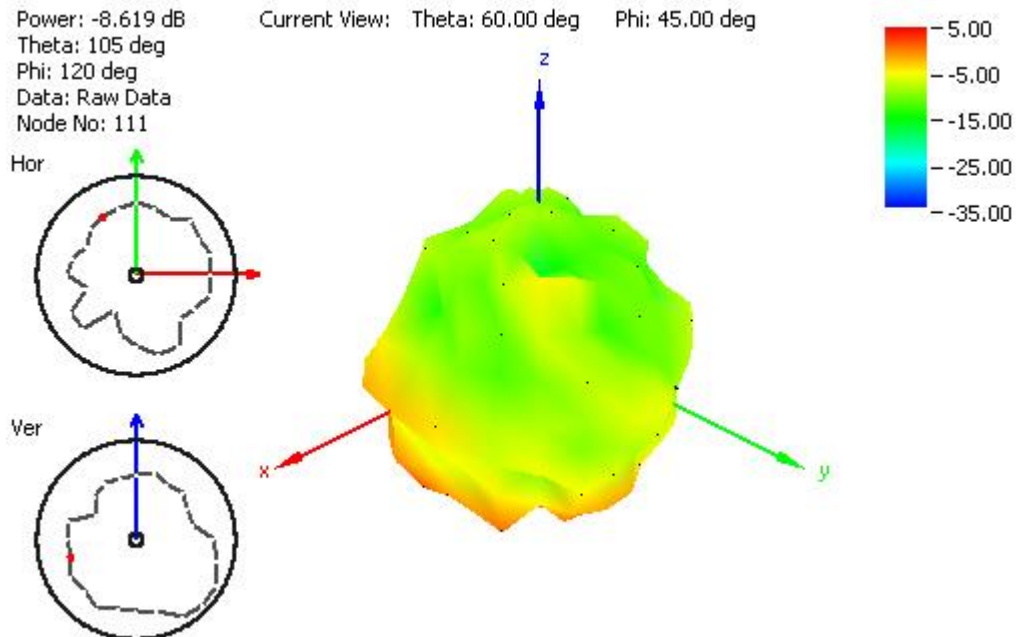
### 5.1 Radiation Patterns (Free Space)



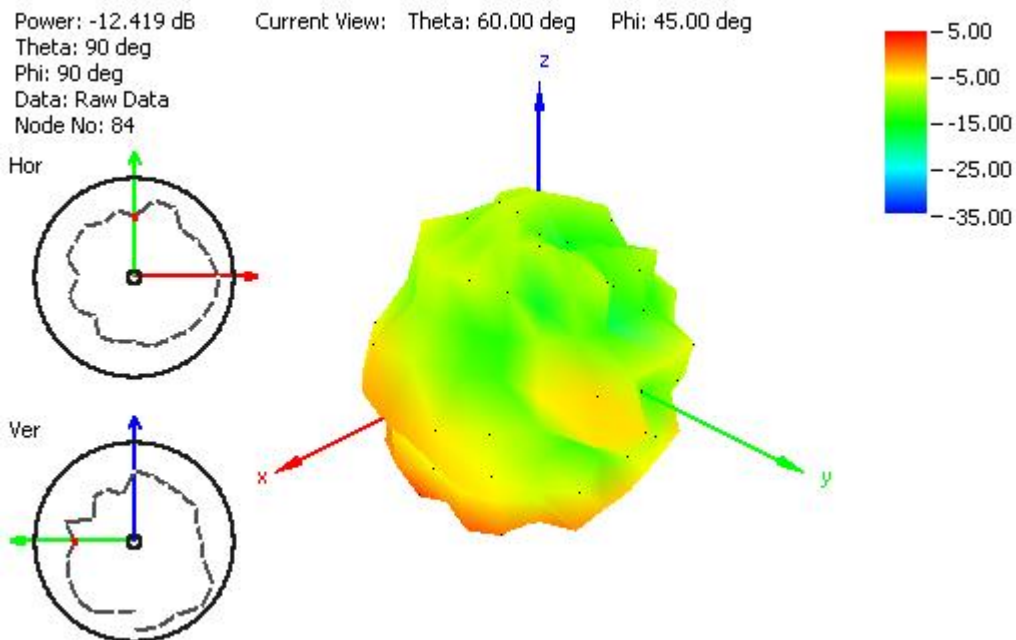
**Figure 11.** Radiation pattern at 849 MHz, Figure 1 as reference (dB), with 2 m RG174 cable and free space



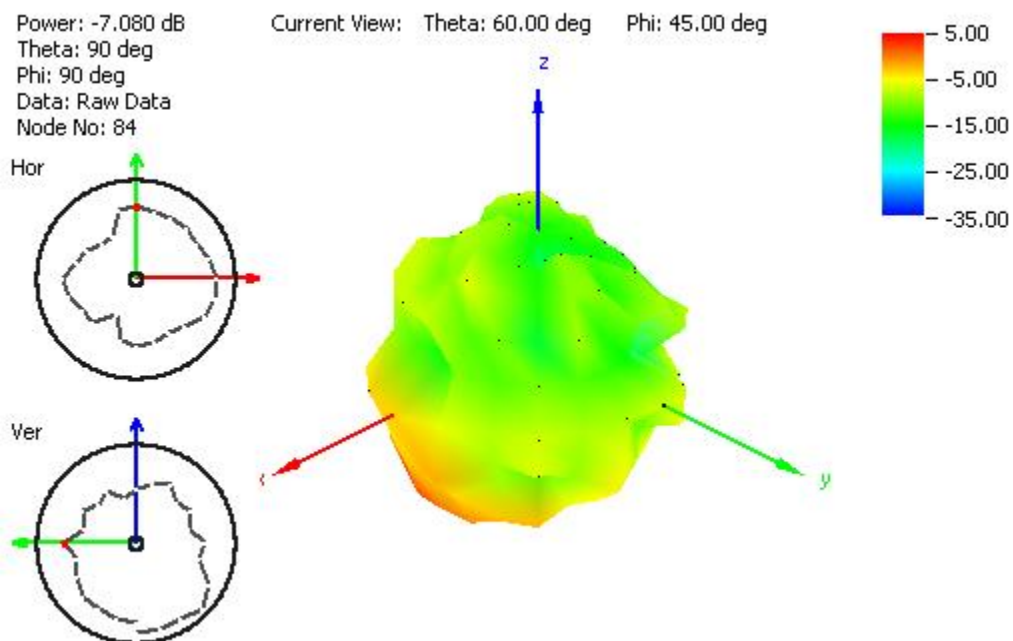
**Figure 12.** Radiation pattern at 915 MHz, Figure 1 as reference (dB), with 2 m RG174 cable and free space.



**Figure 13.** Radiation pattern at 1805 MHz, Figure 1 as reference (dB), with 2 m RG174 cable and free space.

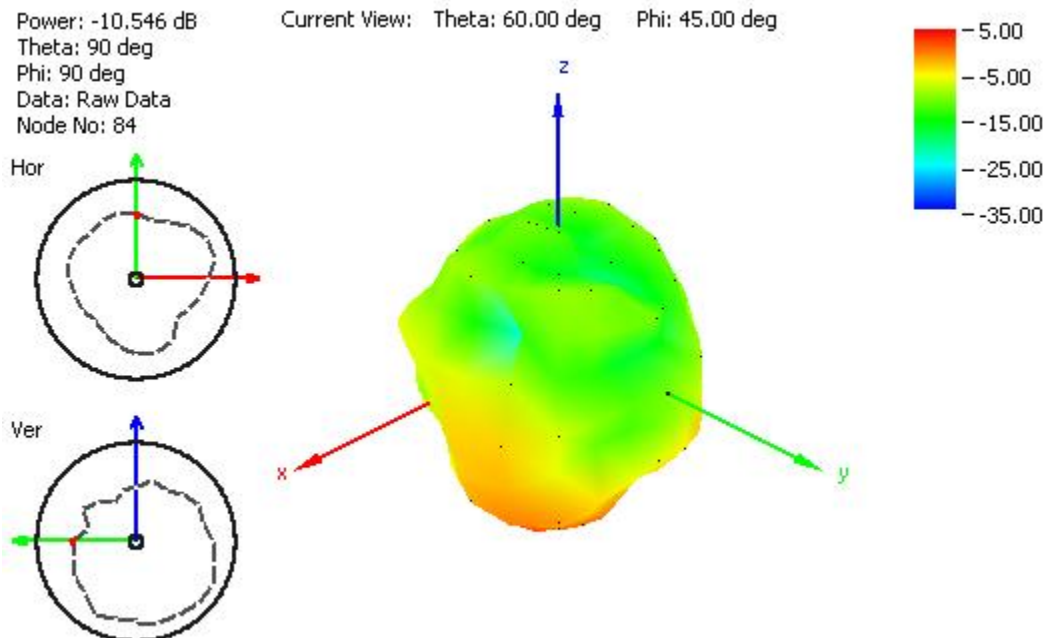


**Figure 14.** Radiation pattern at 1910 MHz, Figure 1 as reference (dB), with 2 m RG174 cable and free space.

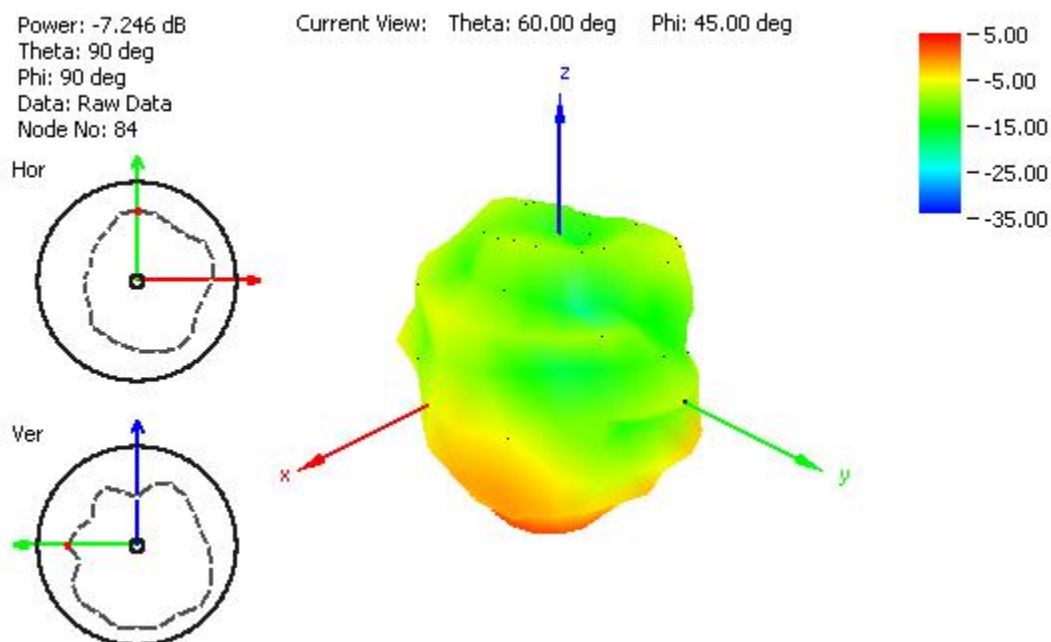


**Figure 15.** Radiation pattern at 2110 MHz, Figure 1 as reference (dB), with 2 m RG174 cable and free space.

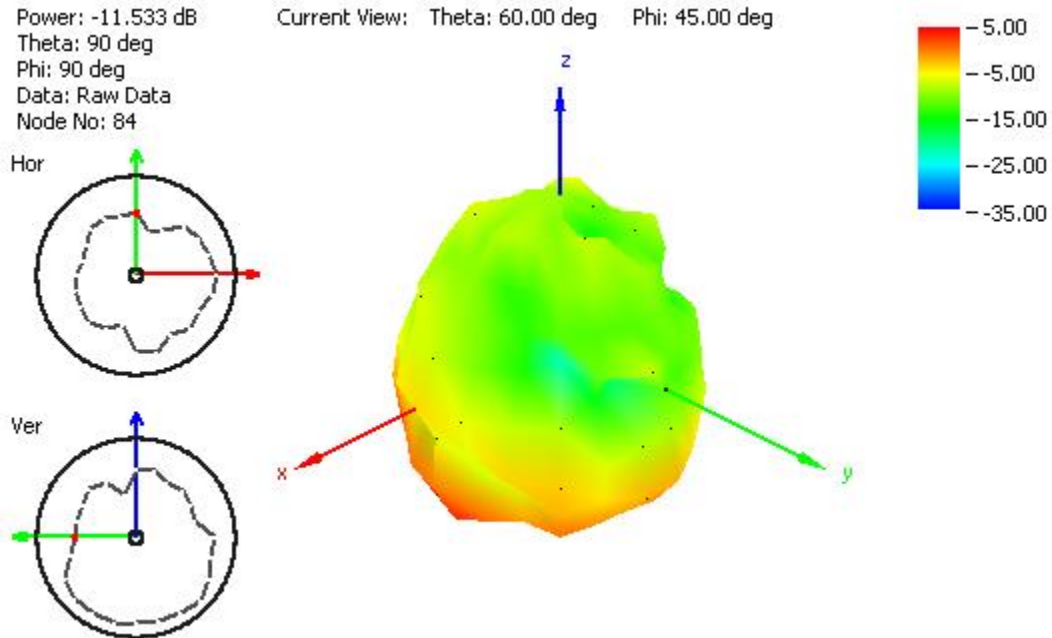
## 5.2 Radiation Patterns (300\*300mm Ground Plane)



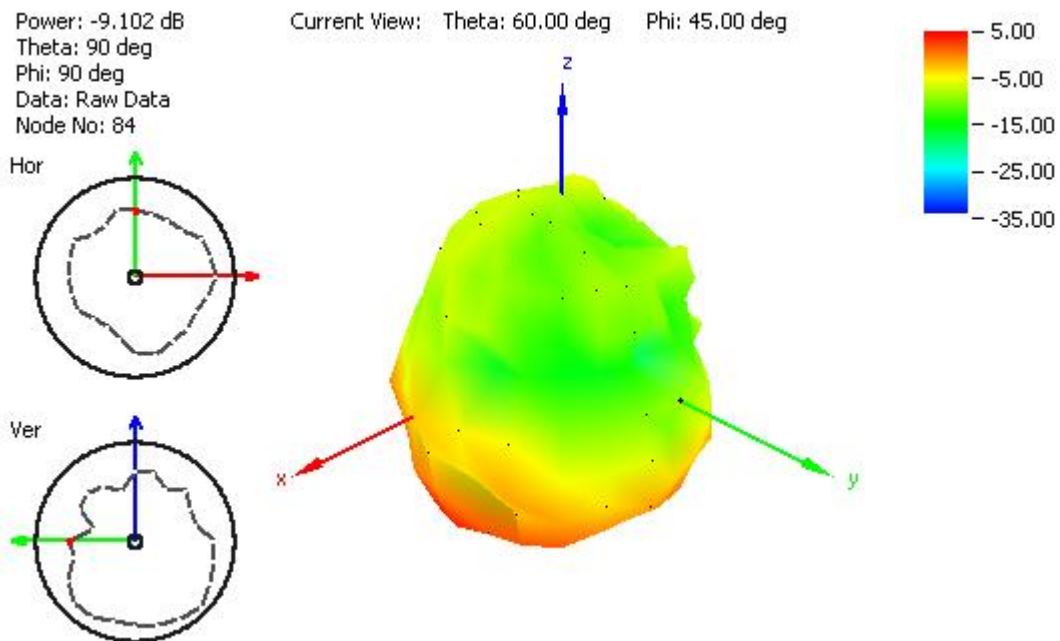
**Figure 16.** Radiation pattern at 849 MHz, Figure 1 as reference (dB), with 2 m RG174 cable and 30x30 cm metal plate.



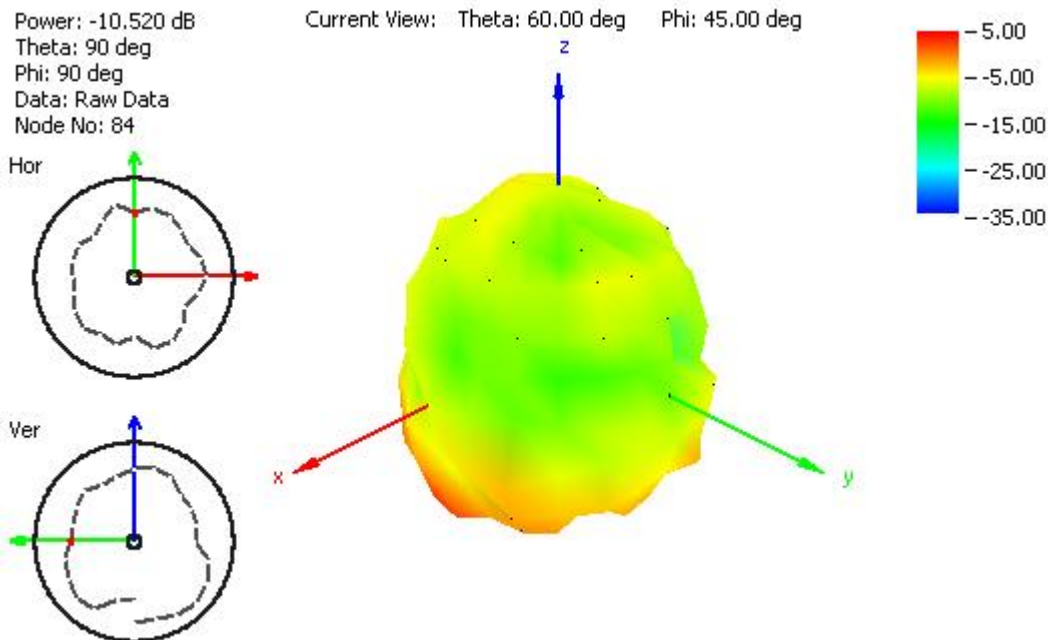
**Figure 17.** Radiation pattern at 915 MHz, Figure 1 as reference (dB), with 2 m RG174 cable and 30x30 cm metal plate.



**Figure 18.** Radiation pattern at 1805 MHz, Figure 1 as reference (dB), with 2 m RG174 cable and 30x30 cm metal plate.

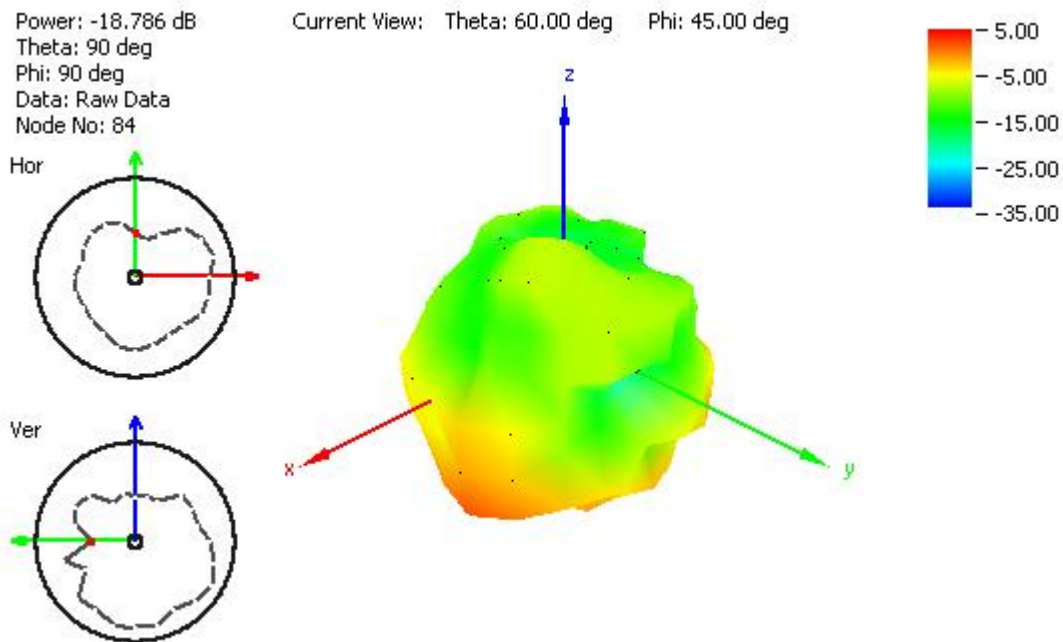


**Figure 19.** Radiation pattern at 1910 MHz, Figure 1 as reference (dB), with 2 m RG174 cable and 30x30 cm metal plate.



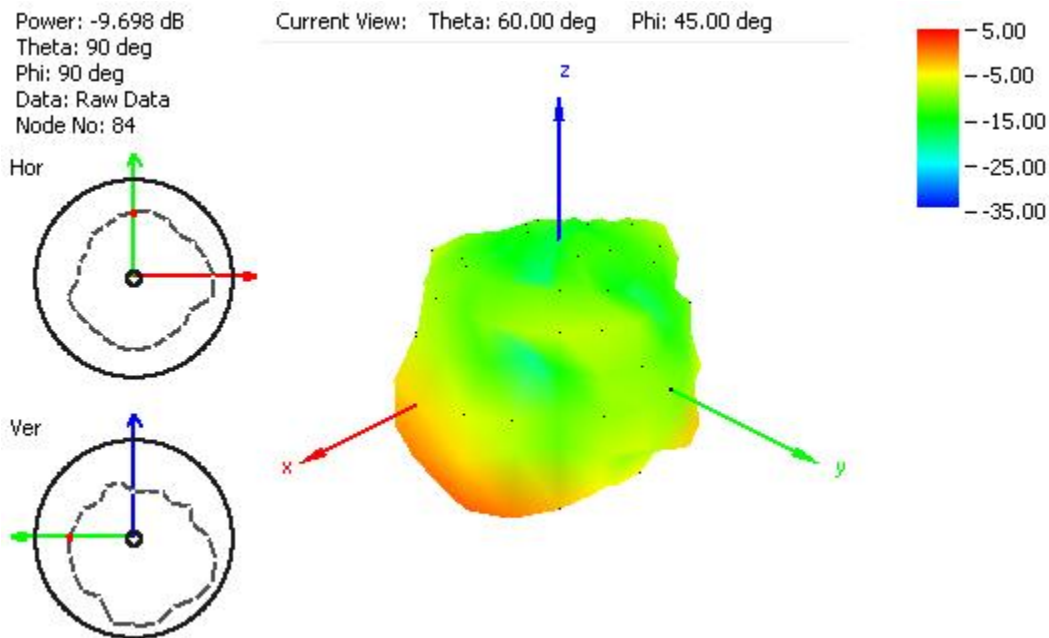
**Figure 20.** Radiation pattern at 2110 MHz, Figure 1 as reference (dB), with 2 m RG174 cable and 30x30 cm metal plate.

### 5.3 Radiation Patterns (600\*600mm Ground Plane)

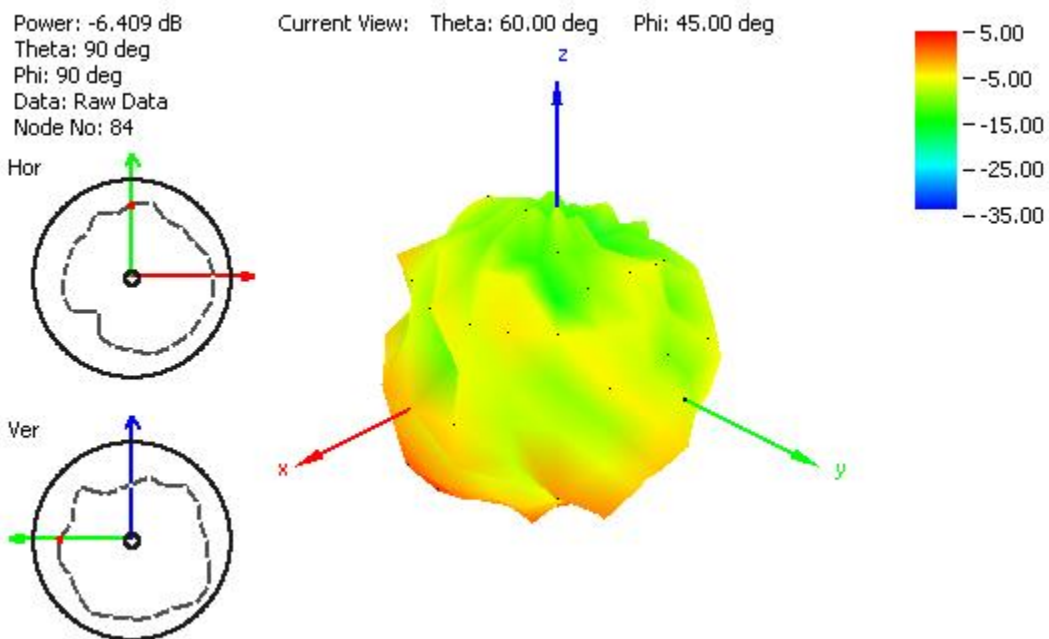


**Figure 21.** Radiation pattern at 849 MHz, Figure 1 as reference (dB), with 2 m RG174 cable and 60x60 cm metal plate.

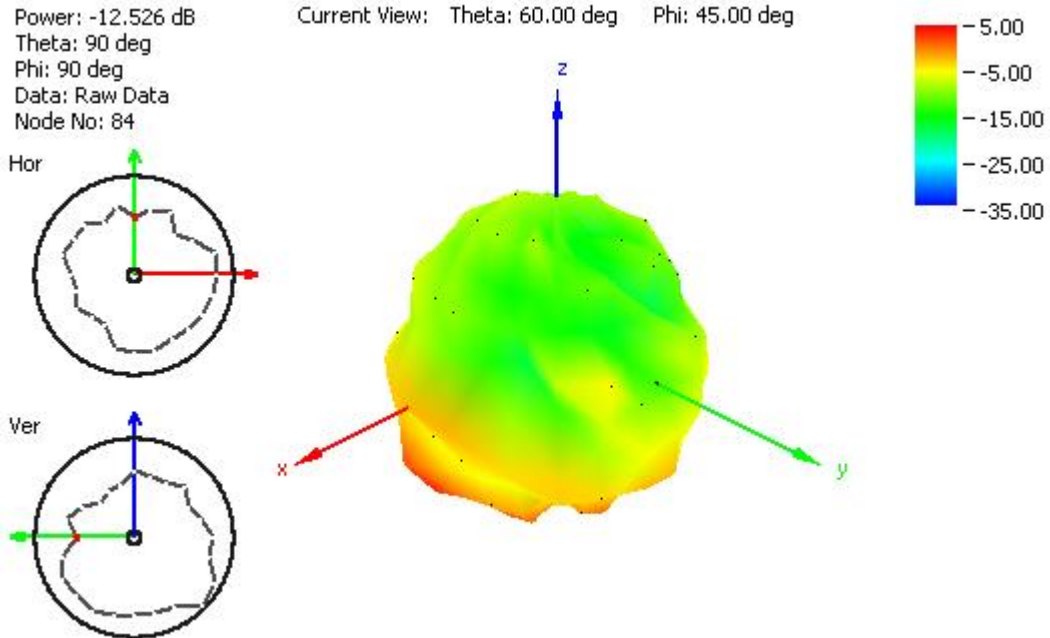




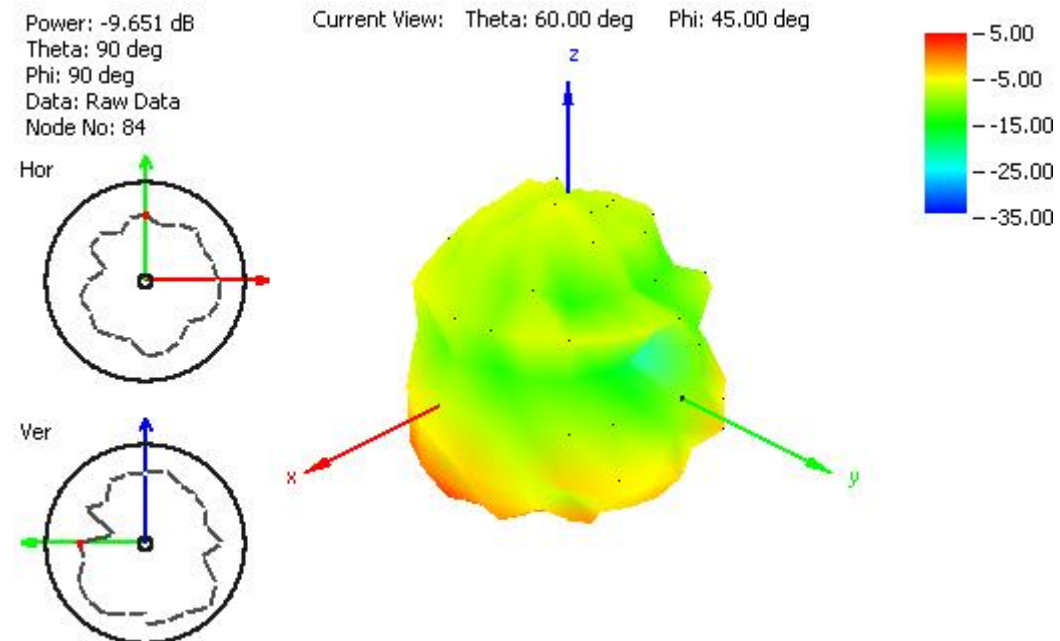
**Figure 22.** Radiation pattern at 915 MHz, Figure 1 as reference (dB), with 2 m RG174 cable and 60x60 cm metal plate.



**Figure 23.** Radiation pattern at 1805 MHz, Figure 1 as reference (dB), with 2 m RG174 cable and 60x60 cm metal plate.

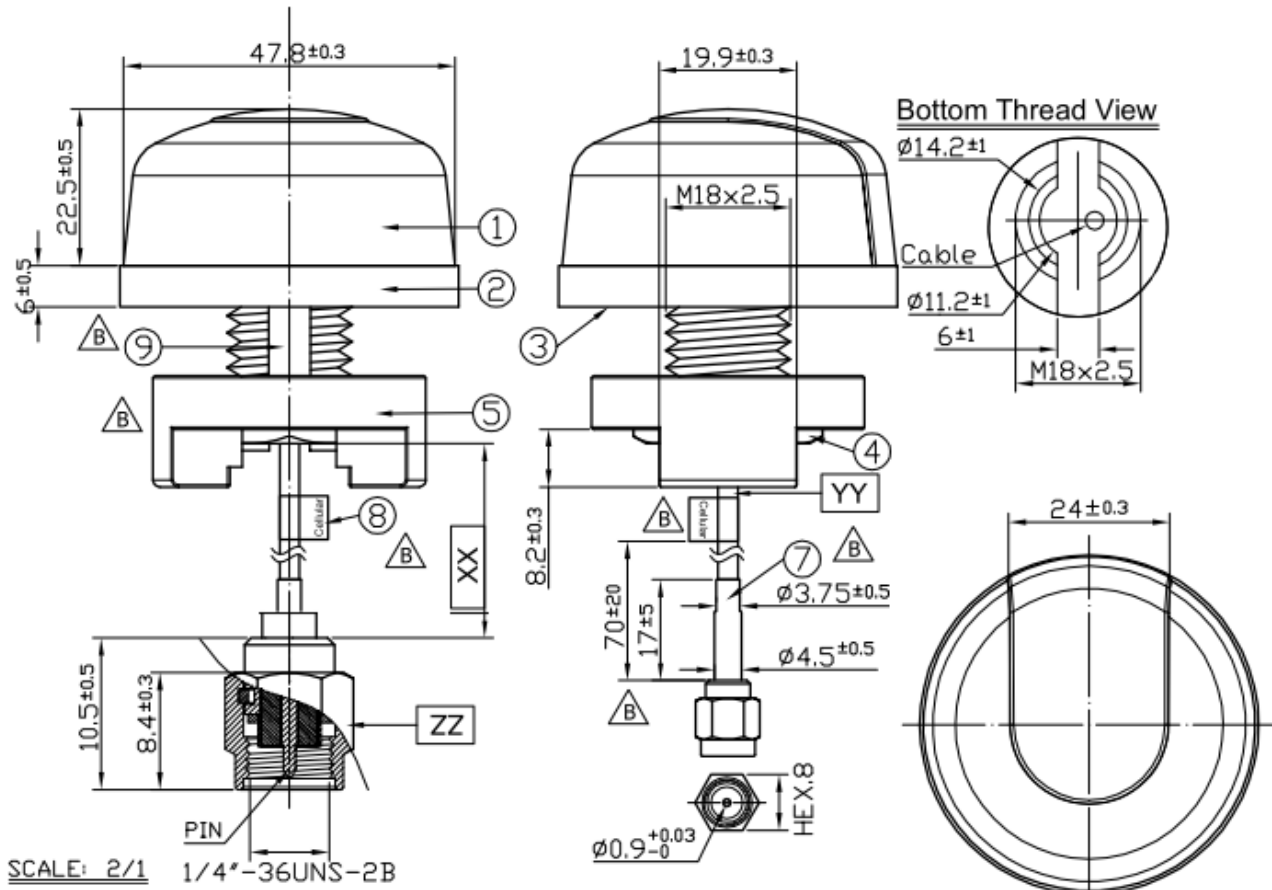


**Figure 24.** Radiation pattern at 1910 MHz, Figure 1 as reference (dB), with 2 m RG174 cable and 60x60 cm metal plate.



**Figure 25.** Radiation pattern at 2110 MHz, Figure 1 as reference (dB), with 2 m RG174 cable and 60x60 cm metal plate.

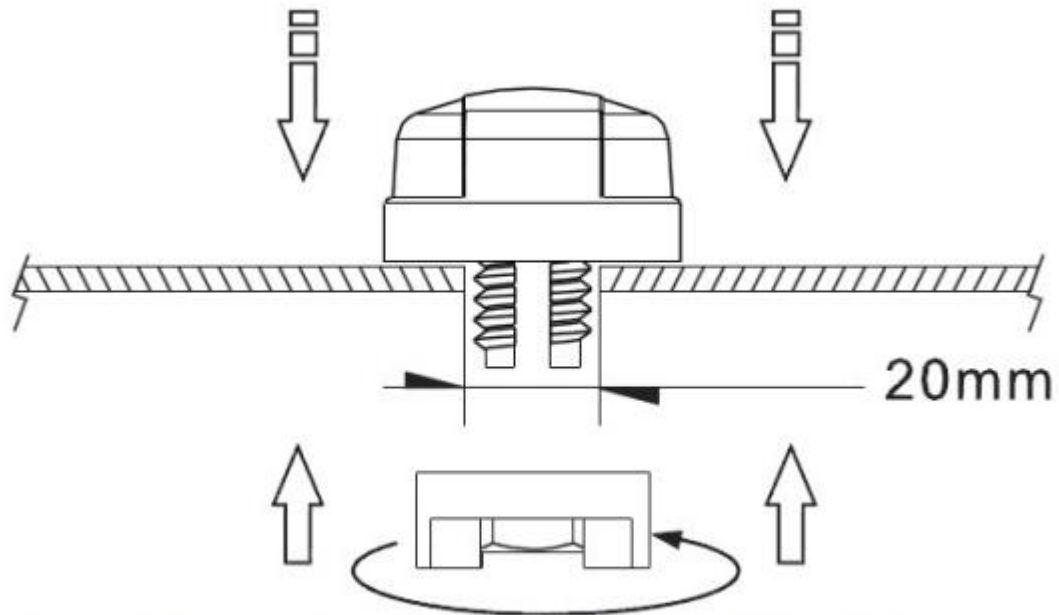
## 6. MECHANICAL DRAWINGS



	Name	Material	Finish	QTY
1	Housing	ABS	White	1
2	Closed Cell Foam	DP-3060W	White	1
3	3M Double Adhesive	3M 9448 HK	White Liner	1
4	M18 Inner Nut	Steel Carbon	Ni Plated	1
5	Outer Nut Cover	ABS	White	1
6	M18x2.5 Thread 14.6L	Zinc Alloy	Ni Plated	1
7	Heat Shrink Tube	PE	Black	1
8	Cellular Label	Coated Paper	Blue	1
9	Rubber Stopper	Rubber	Black	1

	Name	Spec	Finish	QTY
XX	Cable Length	3000mm ±30mm		1
YY	Cable Type	RG174	White	1
ZZ	Connector Type	SMA(M)	Gold	1

## 7. Installation



Recommended torque for Mounting is 24.5N·m  
Maximum torque for mounting is 29.4N·m



## 8. Packaging

1 pcs antenna per big PE bag  
40 big PE bags per box

Unit : mm

