

# SPECIFICATION

## Patent Pending

Part No. : **FXP523.A.07.A.001**

Product Name : **Venti WiFi MIMO\*3**  
**2.4/5.8GHz Embedded Flexible Antenna 3 ports for**  
**802.11ac applications**

Feature : 80\*20\*0.15mm  
Efficiency - Typical 60%+ Peak Gain - Typical 3dBi to 6dBi\*  
Port 1&2&3-120mm cable length  
1.13 mm micro coax cable with IPEX MHFI (U.FL comp)  
connector  
3M Adhesive tape for easy mounting.  
Cables and Connectors are customizable.  
**RoHS Compliant**

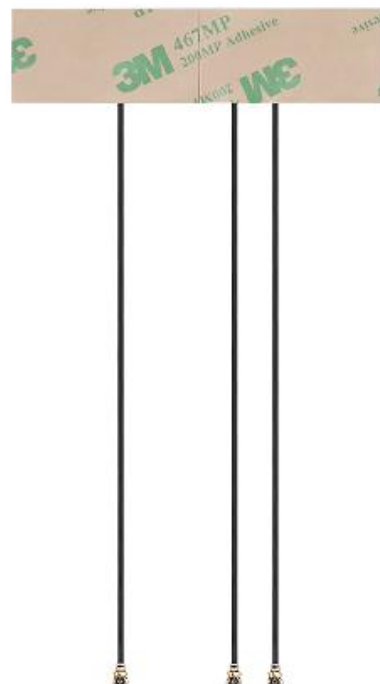
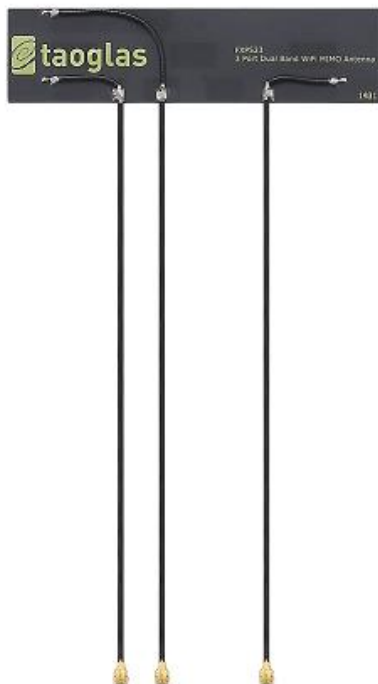

## 1. Introduction

The unique FXP.523 Venti antenna is a 3-in-1 MIMO, embedded flexible monopole type antenna for high speed 802.11ac WiFi dual-band applications.

It has over 40% efficiency in the 2.4GHz bands, and over 50% in the 5GHz bands. Featuring a low profile height of only 0.15mm, the FXP.523 is an ideal solution for

- Gateways
- Routers
- Applications Points

Great care has been taken to have high isolation (at least 15dB) between the three elements to ensure optimal MIMO system throughput. The antenna has been designed on a flexible material with a rectangular form-factor and cable connection for an easy installation. The antenna comes with double-sided 3M tape for easy and robust "peel and stick" mounting. The FXP523 cables terminate with IPEX (u.fl) connectors for easy installation.

\*If needed in order to comply with peak gain restrictions with certain wireless modules, the antenna peak gain can be reduced by simply using longer cable, or when tested in the actual device environment.

Many module manufacturers specify peak gain limits for any antennas that are to be connected to that module. Those peak gain limits are based on free-space conditions. In practice, the peak gain of an antenna tested in free-space can degrade by at least 1 or 2dBi when put inside a device. So ideally you should go for a slightly higher peak gain antenna than mentioned on the module specification to compensate for this effect, giving you better performance.

Upon testing of any of our antennas with your device and a selection of appropriate layout, integration technique, or cable, Taoglas can make sure any of our antennas' peak gain will be below the peak gain limits. Taoglas can then issue a specification and/or report for the selected antenna in your device that will clearly show it complying with the peak gain limits, so you can be assured you are meeting regulatory requirements for that module.

For example, a module manufacturer may state that the antenna must have less than 2dBi peak gain, but you don't need to select an embedded antenna that has a peak gain of less than 2dBi in free-space. This will give you a less optimized solution. It is better to go for a slightly higher free-space peak gain of 3dBi or more if available. Once that antenna gets integrated into your device, performance will degrade below this 2dBi peak gain due to the effects of GND plane, surrounding components, and device housing. If you want to be absolutely sure, contact Taoglas and we will test. Choosing a Taoglas antenna with a higher peak gain than what is specified by the module manufacturer and enlisting our help will ensure you are getting the best performance possible without exceeding the peak gain limits.

Customized cable lengths and connector versions can be supplied. Contact a Taoglas regional support center for support.

## 2. Specification

| ELECTRICAL         |           |           |           |           |           |           |
|--------------------|-----------|-----------|-----------|-----------|-----------|-----------|
|                    | Port 1    |           | Port 2    |           | Port 3    |           |
| Frequency (MHz)    | 2400-2500 | 5150-5850 | 2400-2500 | 5150-5850 | 2400-2500 | 5150-5850 |
| Peak Gain (dBi)    | 2.63      | 4.60      | 4.54      | 6.69      | 3.91      | 5.25      |
| Average Gain (dBi) | -2.63     | -1.96     | -1.99     | -1.78     | -2.03     | -1.58     |
| Efficiency (%)     | 54.72     | 64.03     | 63.32     | 66.80     | 62.79     | 69.88     |
| Impedance          | 50Ω       |           |           |           |           |           |
| Polarization       | Linear    |           |           |           |           |           |

|                       |                               |
|-----------------------|-------------------------------|
| Radiation Pattern     | Omni-directional              |
| Input Power           | 2W Max.                       |
| <b>MECHANICAL</b>     |                               |
| Dimensions            | 80mm X 20mm X 0.1mm           |
| Antenna Body Material | Polymer                       |
| Cable                 | 3* Black 1.13mm Coaxial Cable |
| Cable Length          | 120mm                         |
| Connector             | IPEX MHFI                     |
| Weight                | 7g                            |
| <b>ENVIRONMENTAL</b>  |                               |
| Temperature Range     | -40°C to 85°C                 |
| Humidity              | Non-condensing 65°C 95% RH    |

\*The antenna was measured with 2mm thick ABS plastic base.

### 3. Antenna Characteristics

#### 3.1 Return Loss

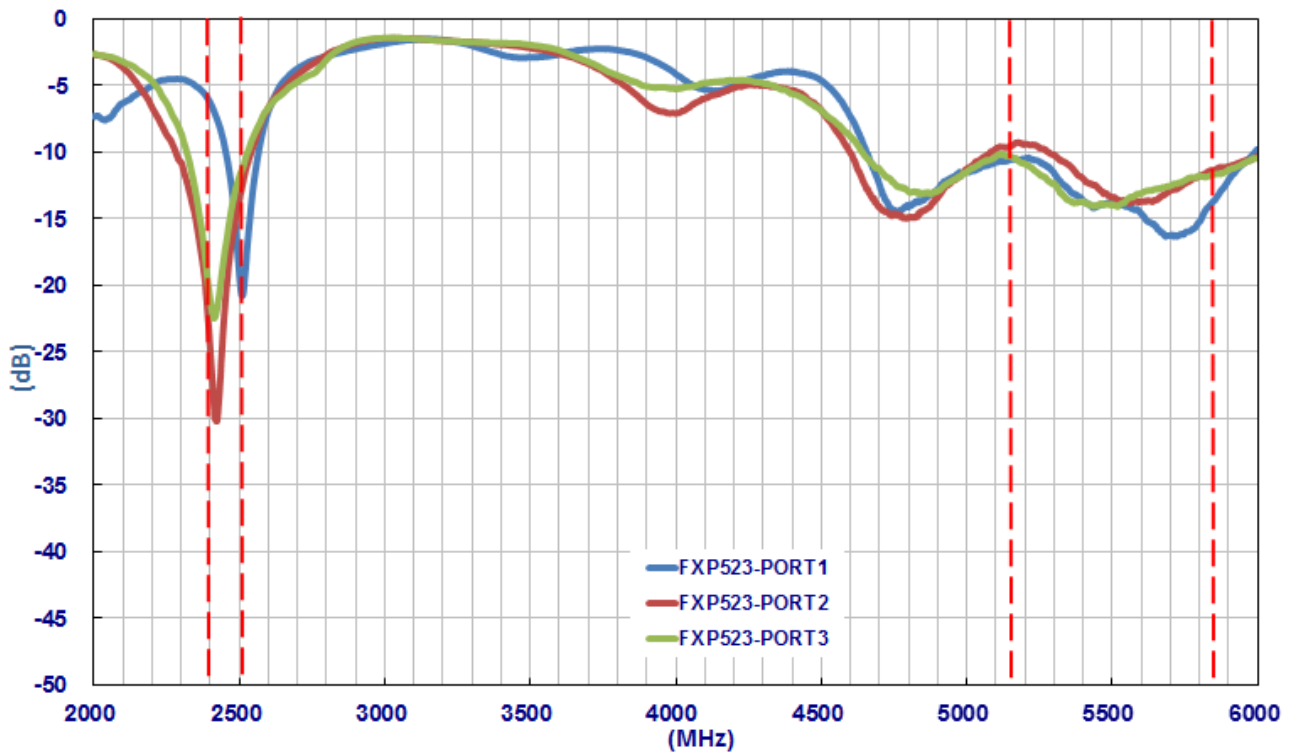

### 3.2 Antenna Isolation

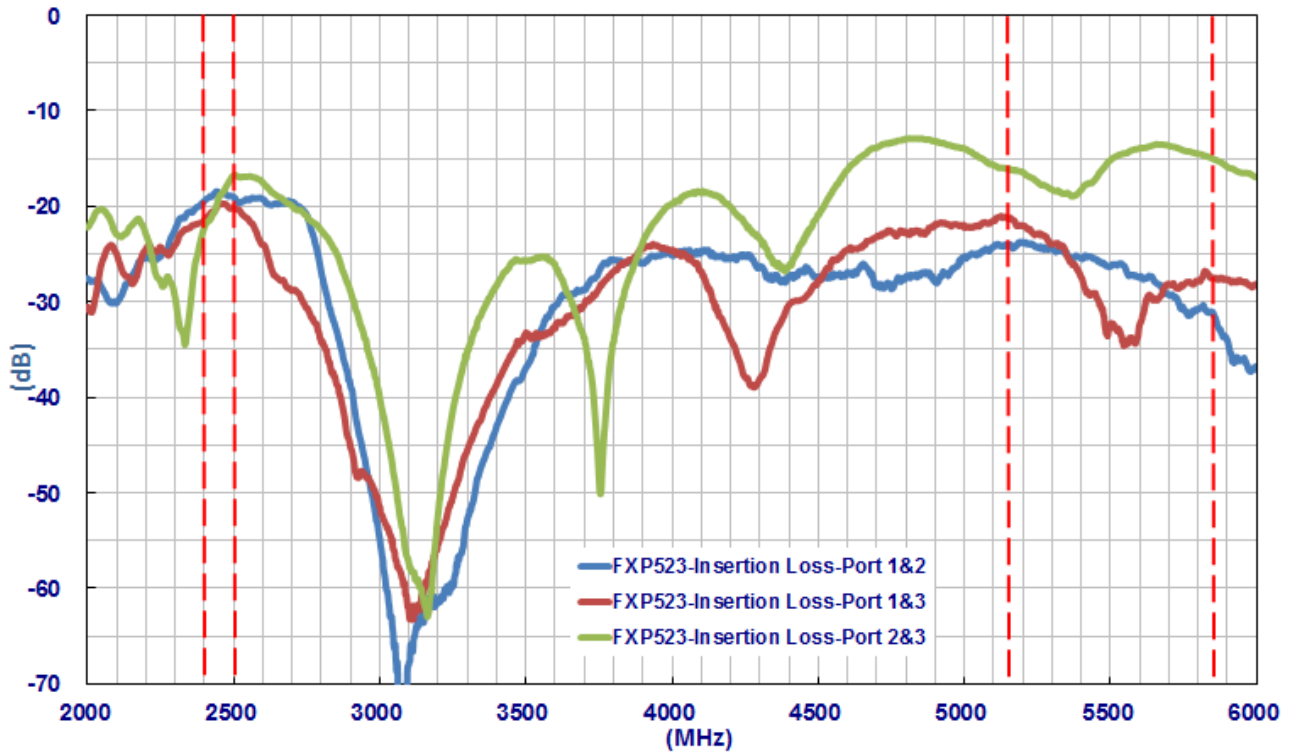

### 3.3 Peak Gain

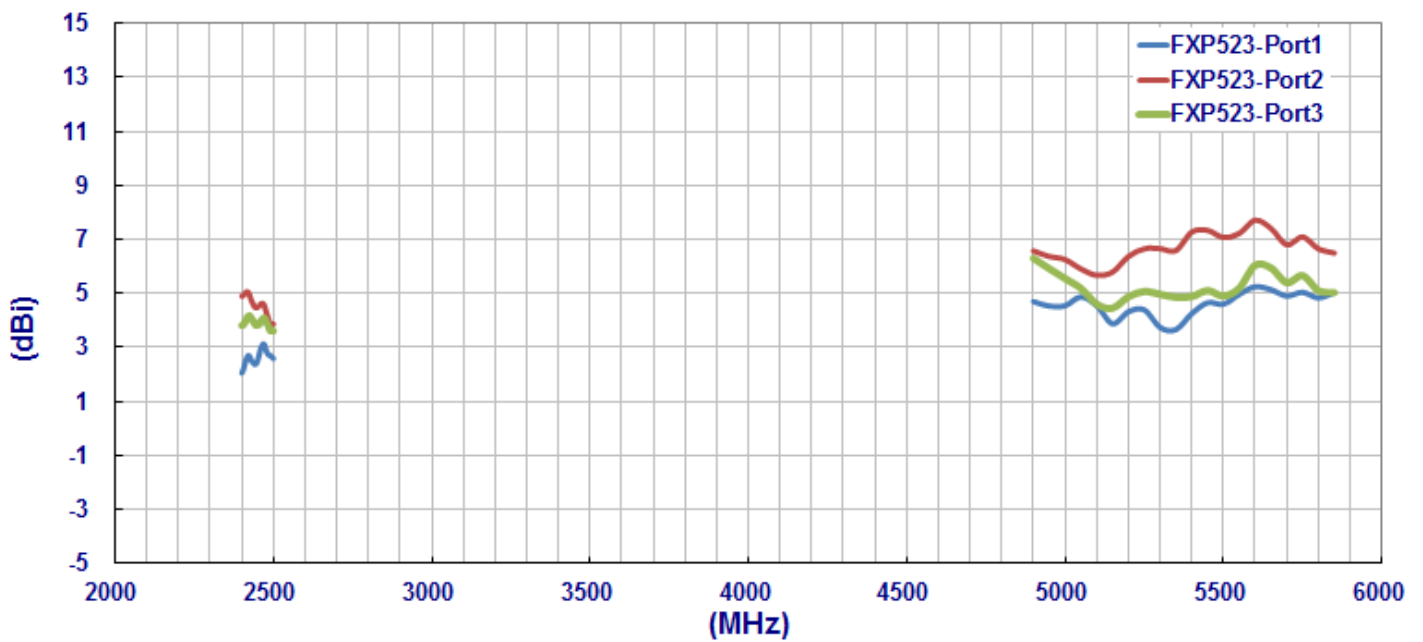

### 3.4 Average Gain

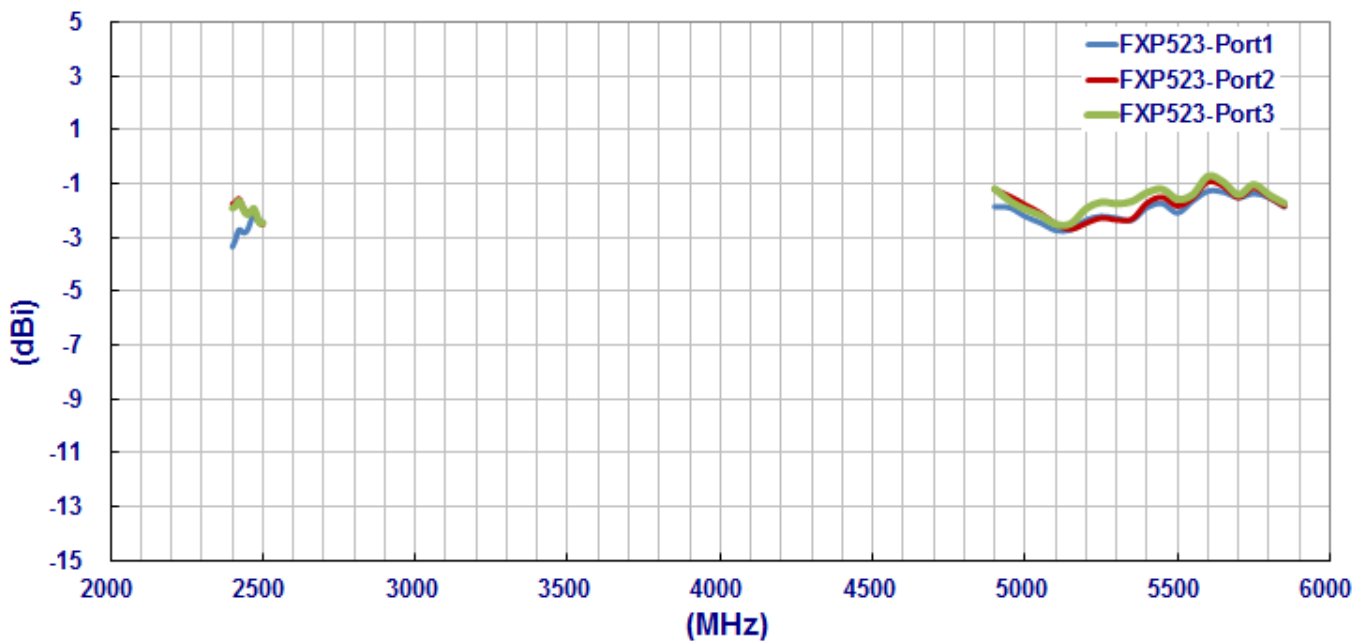

### 3.5 Efficiency

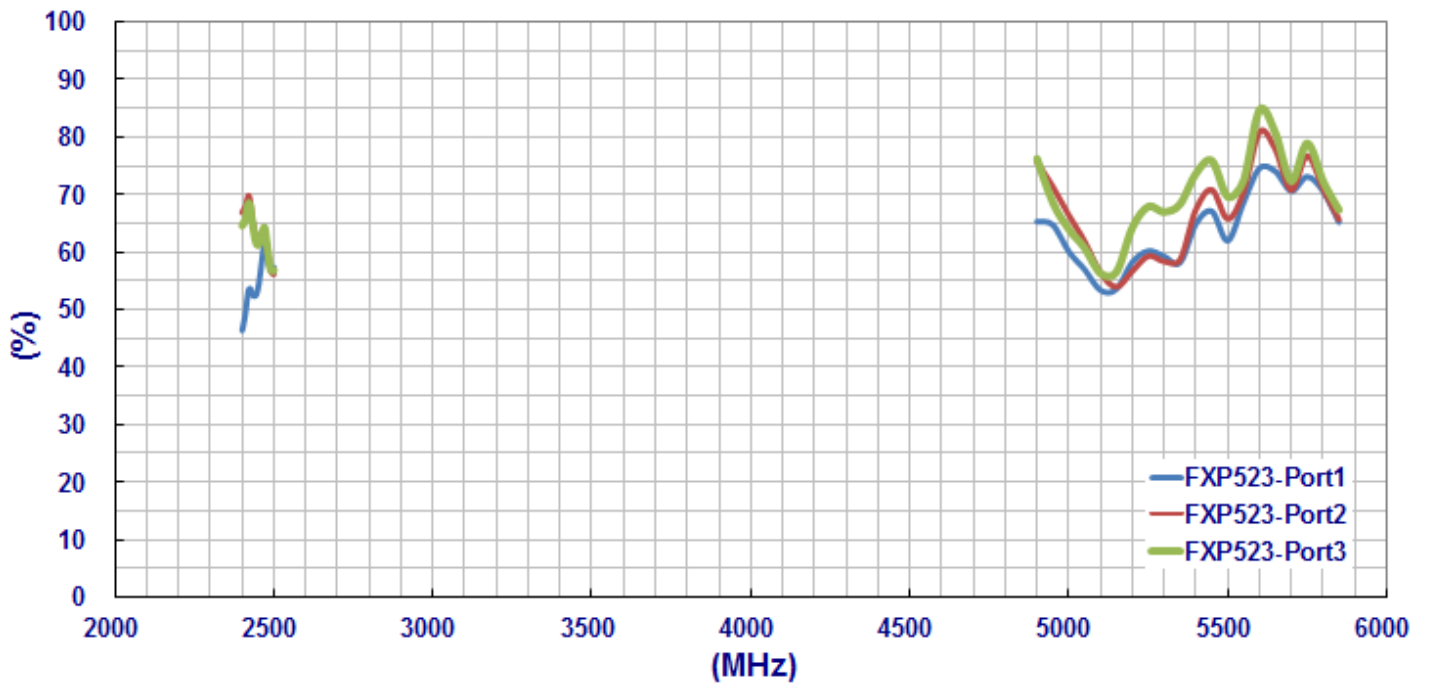

## 4. Antenna Radiation Patterns

### 4.1 Antenna Coordinates Setup



## 5. Radiation Patterns

### 5.1 The radiation pattern of FXP.523 antenna (Port 1)

XY Plane

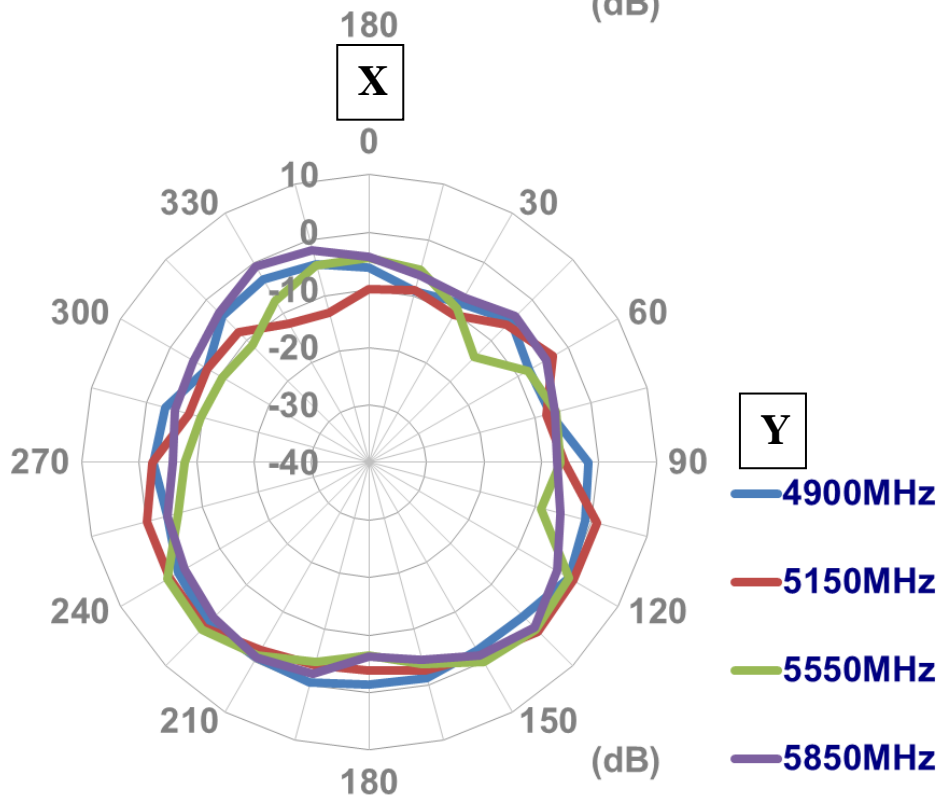
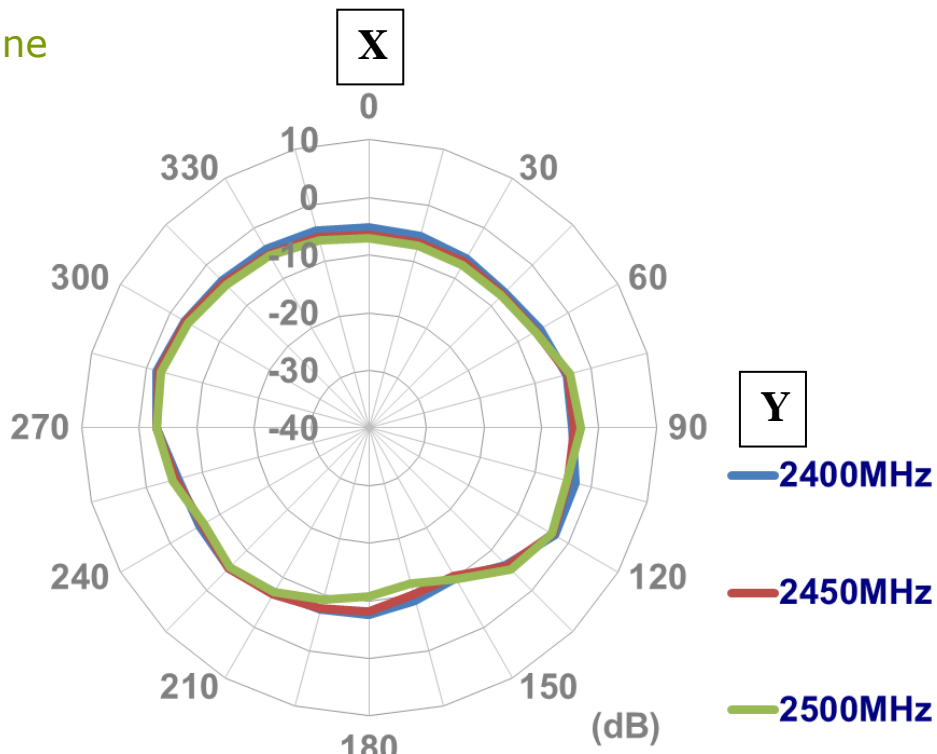



XZ plane

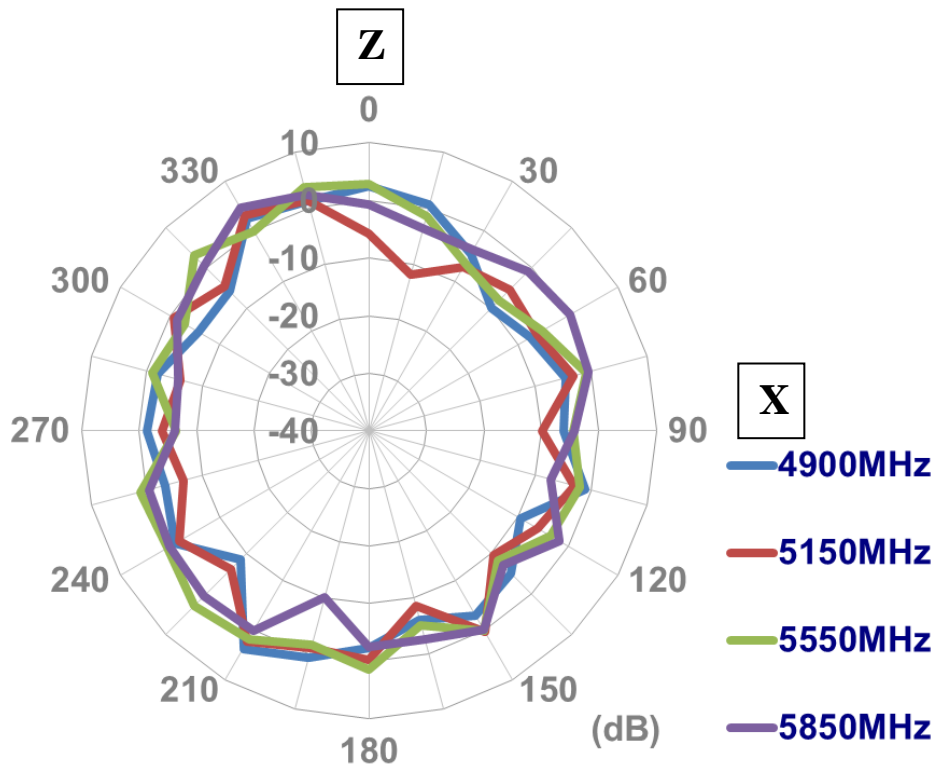
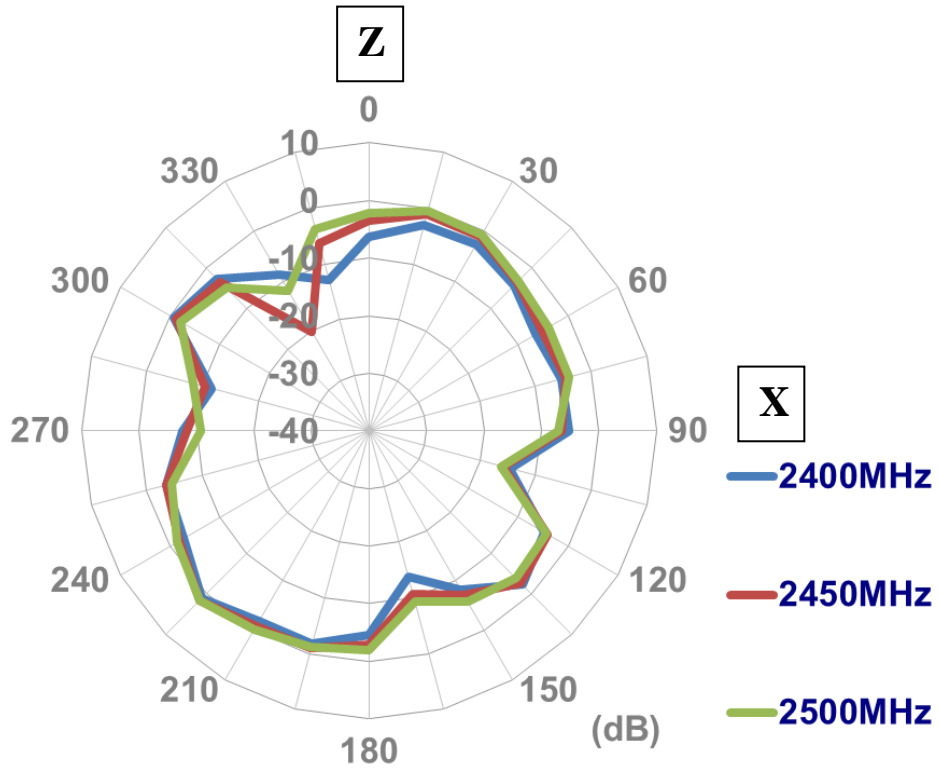

YZ Plane

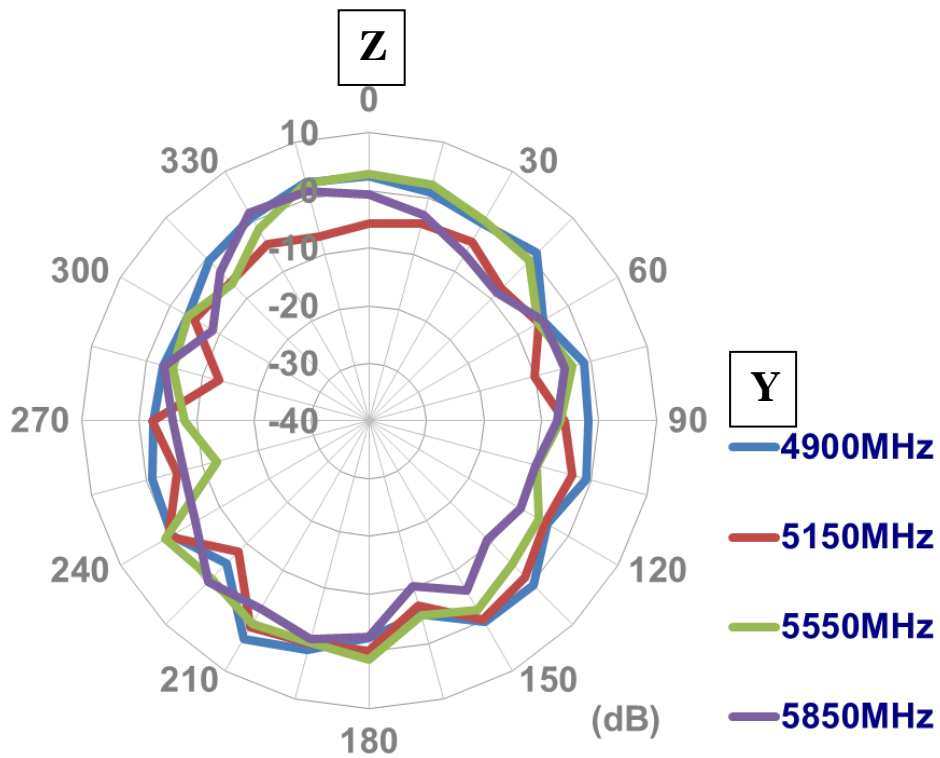
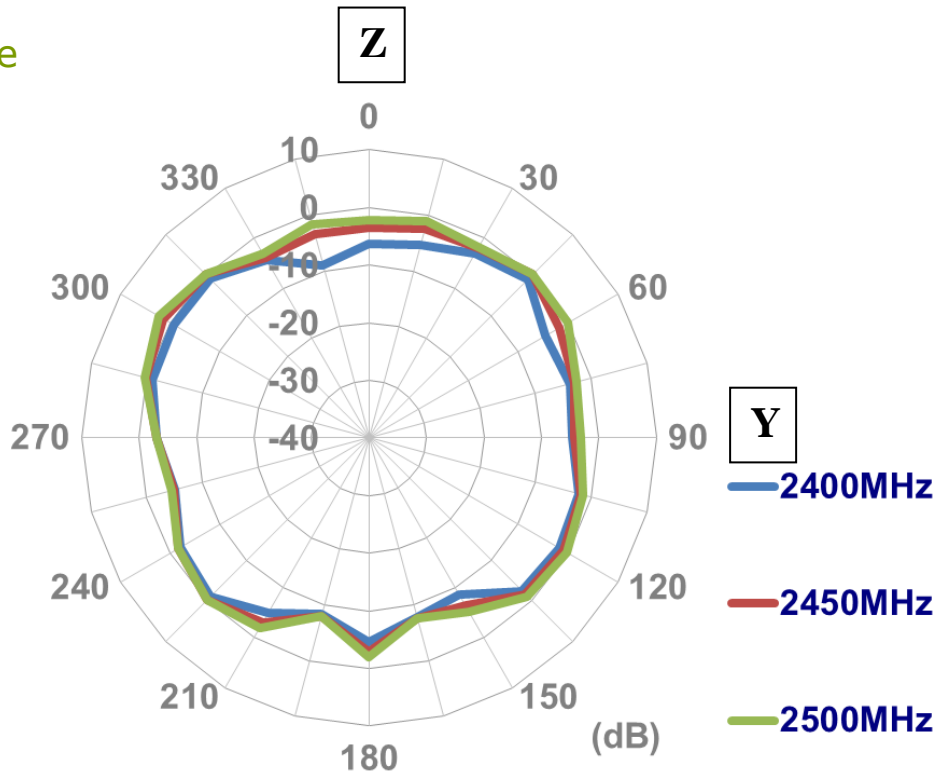

## 5.2 The radiation pattern of FXP.523 antenna (Port 2)

XY plane

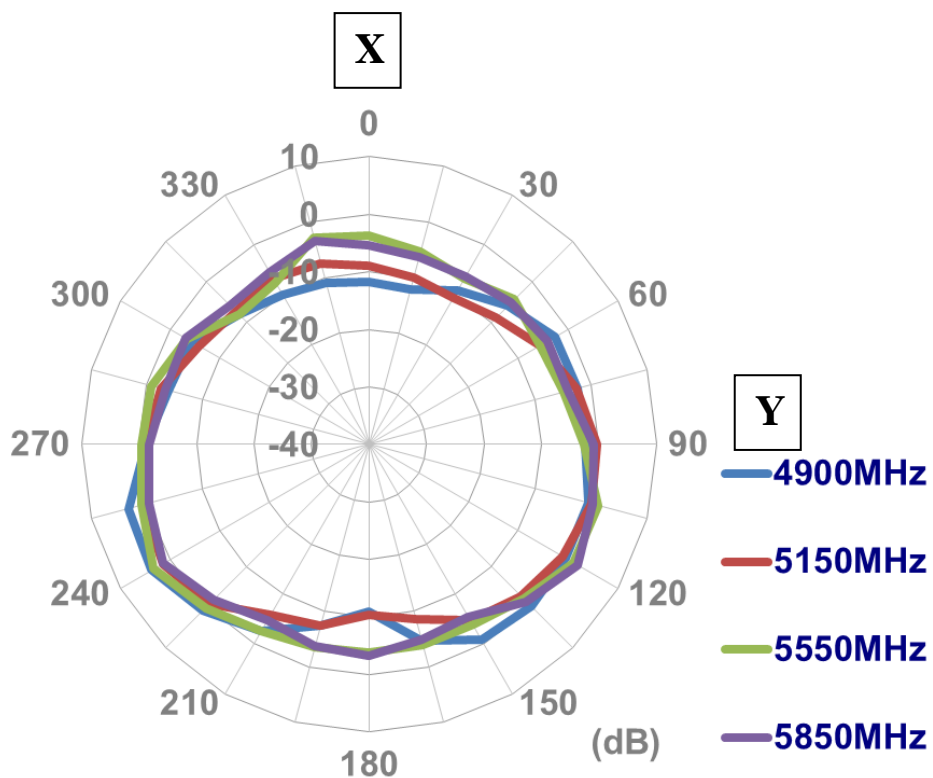
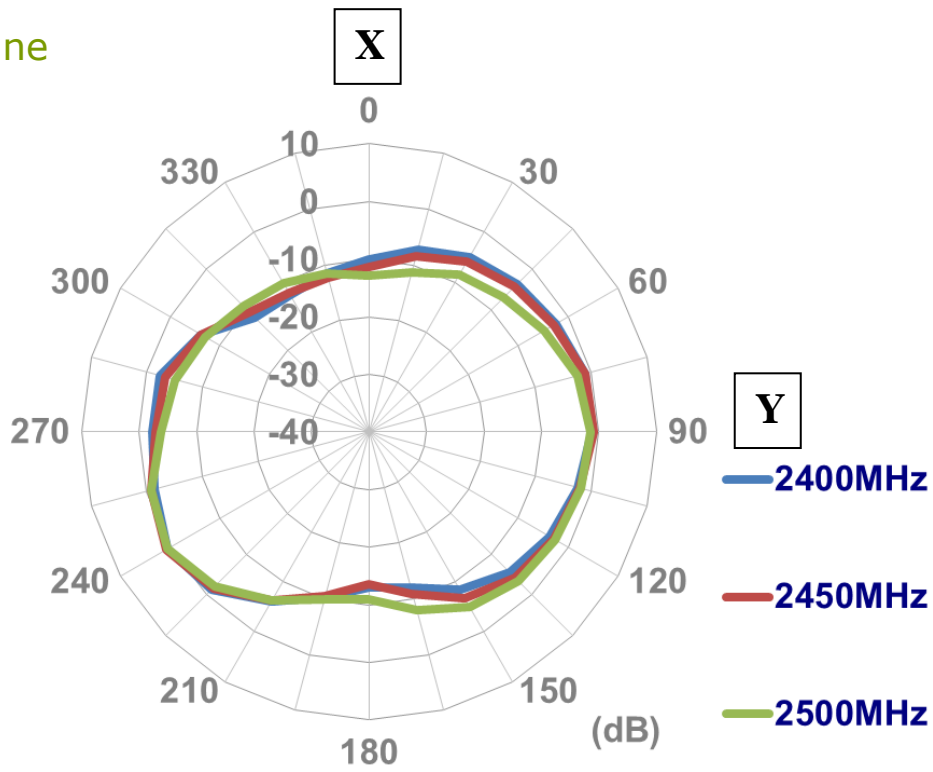

XZ Plane

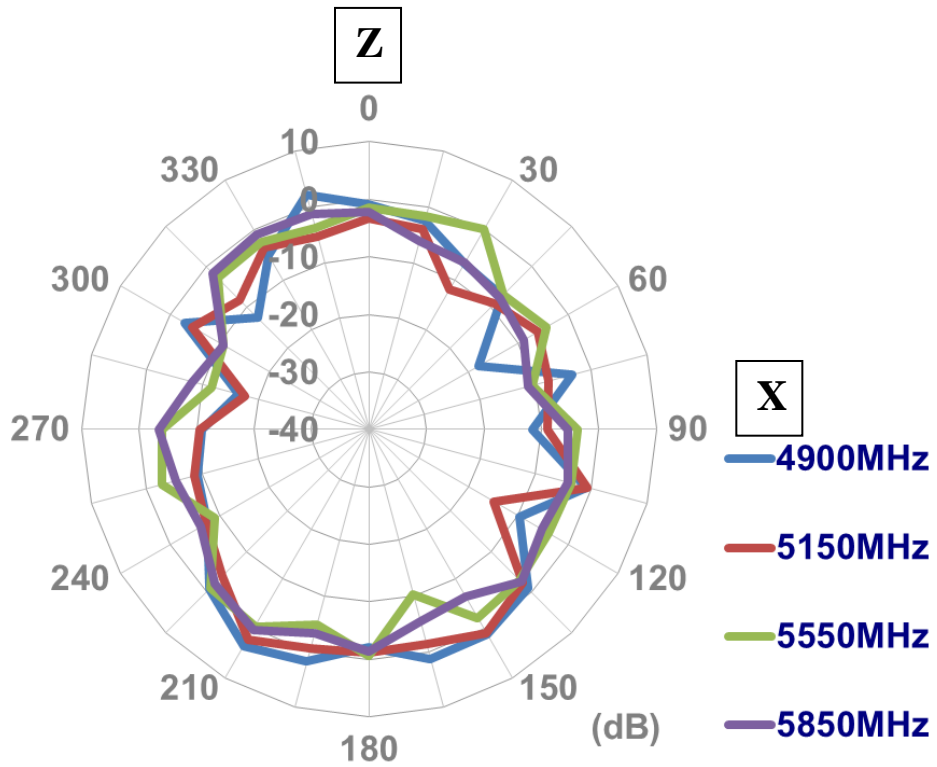
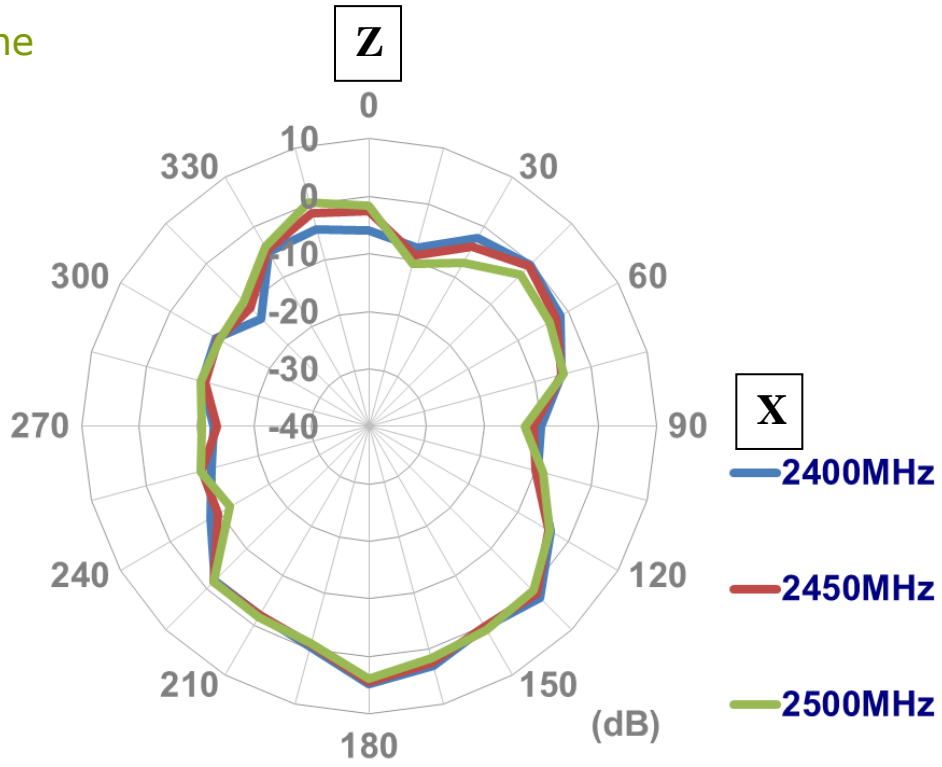

YZ Plane

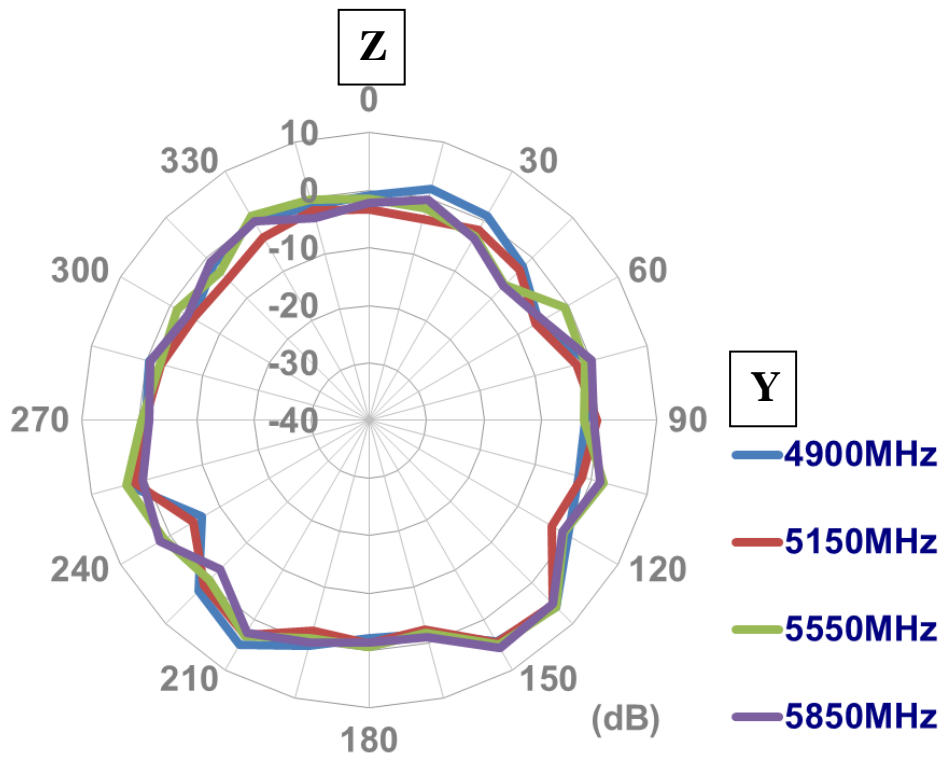
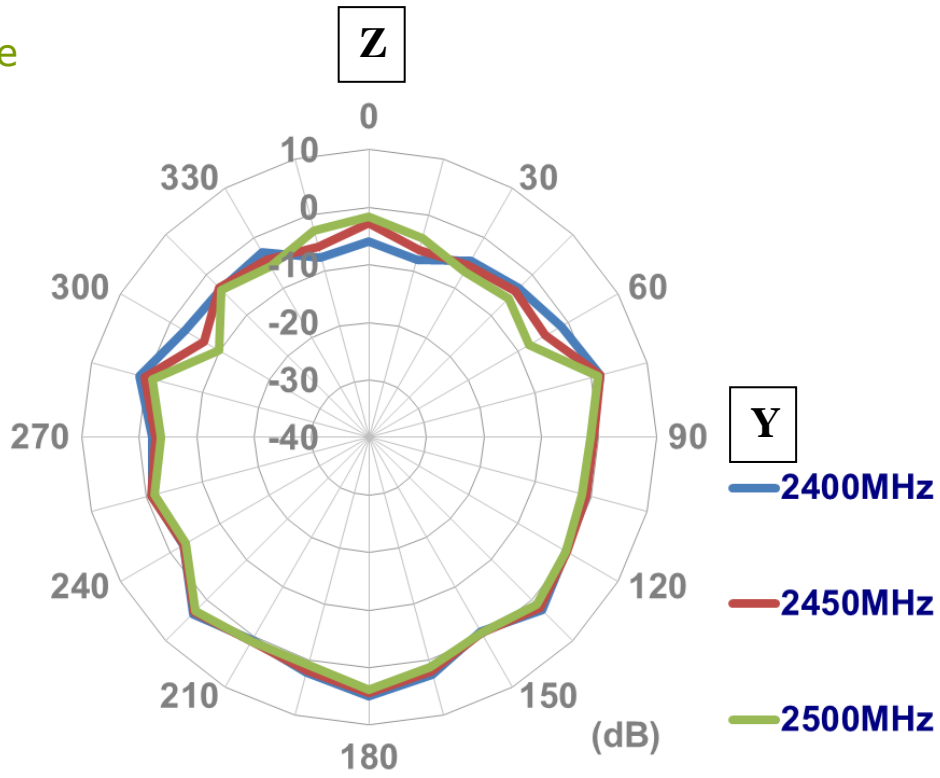

### 5.3 The radiation pattern of FXP.523 antenna (Port 3)

XY plane

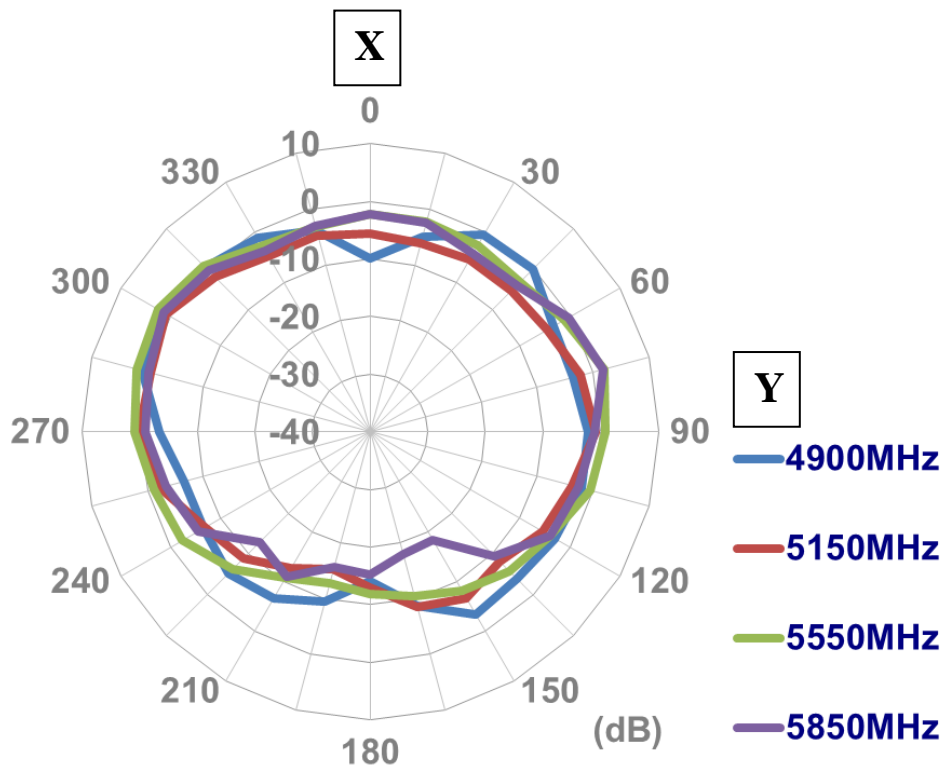
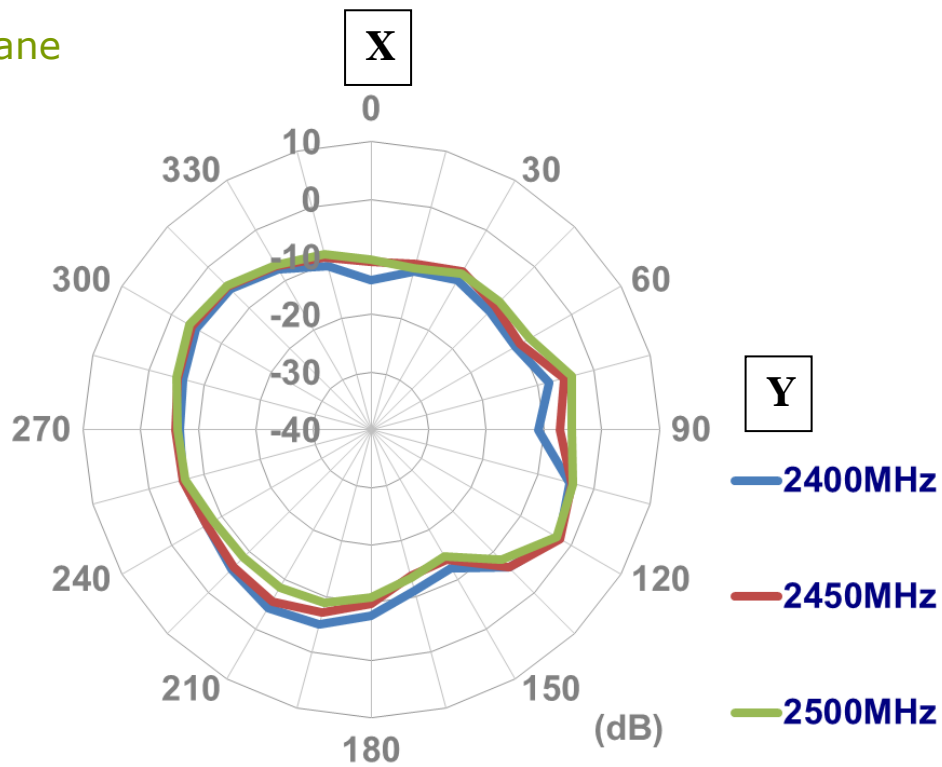

XZ Plane

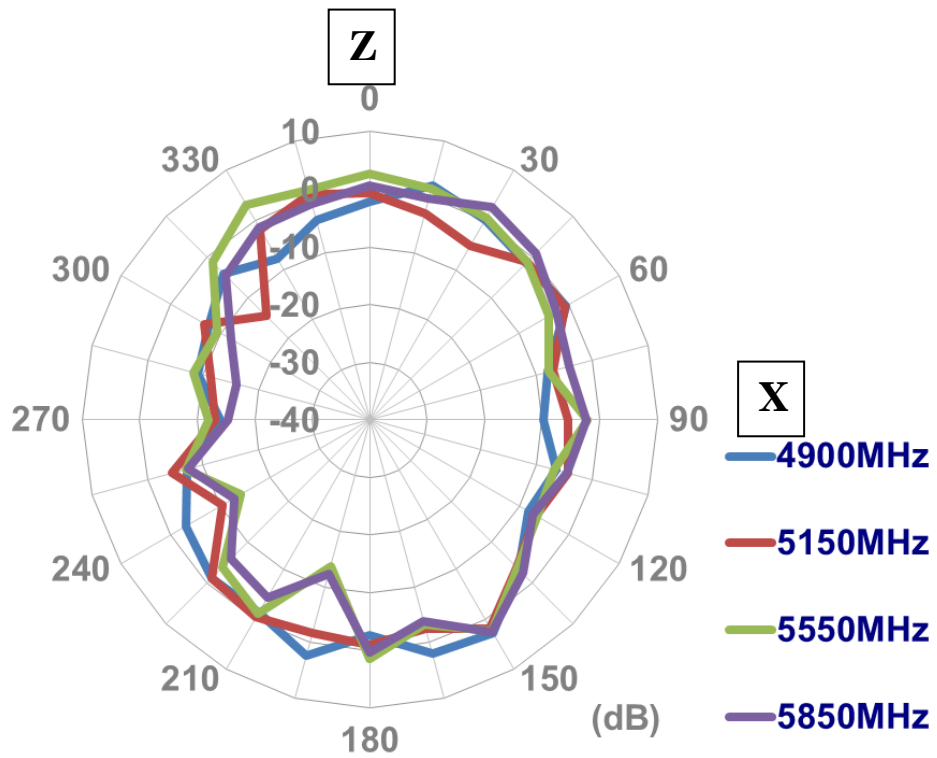
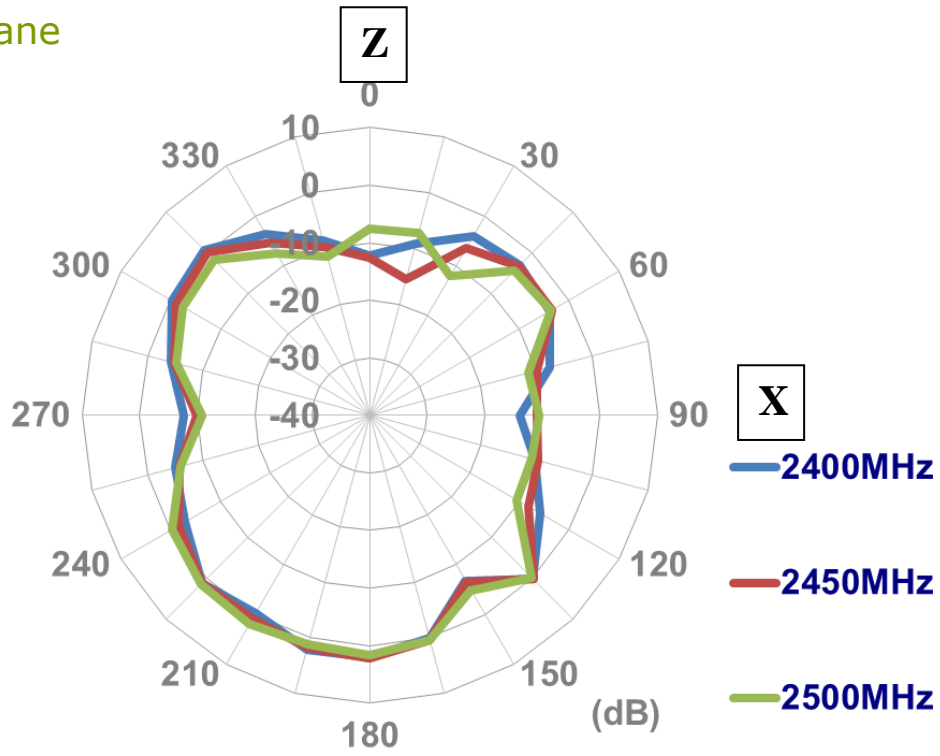

YZ Plane

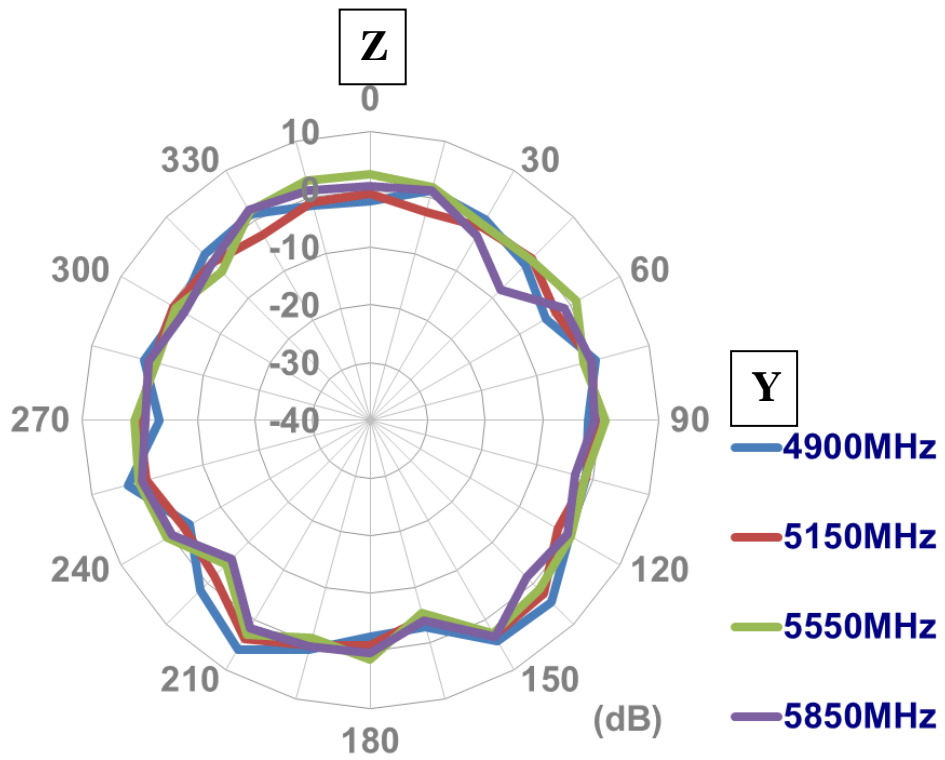
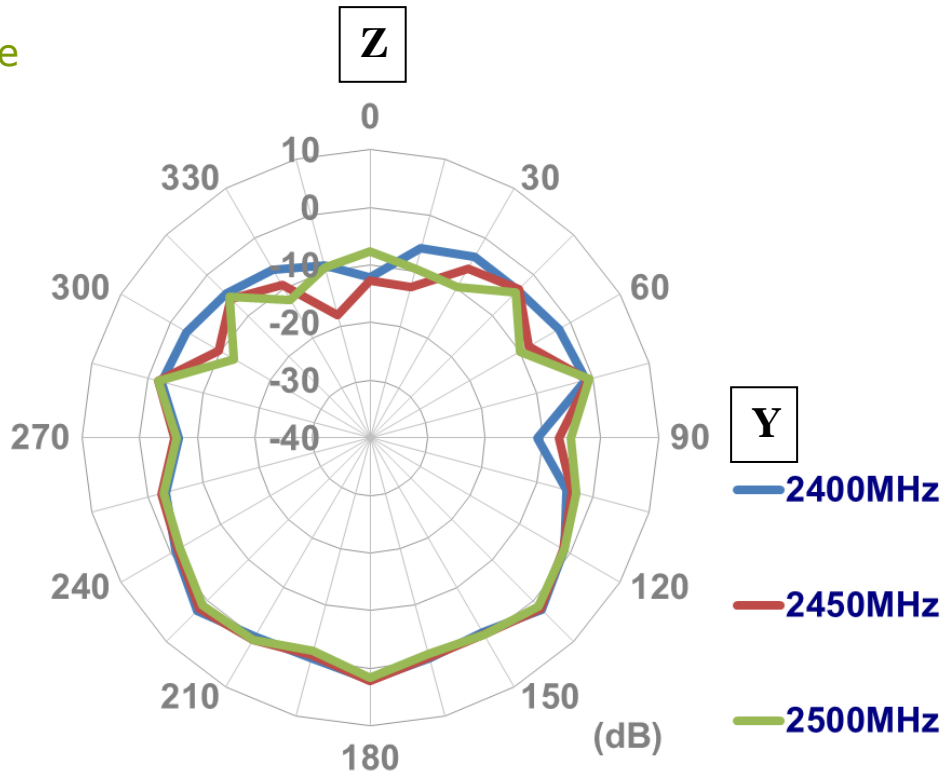



## 6. Drawing

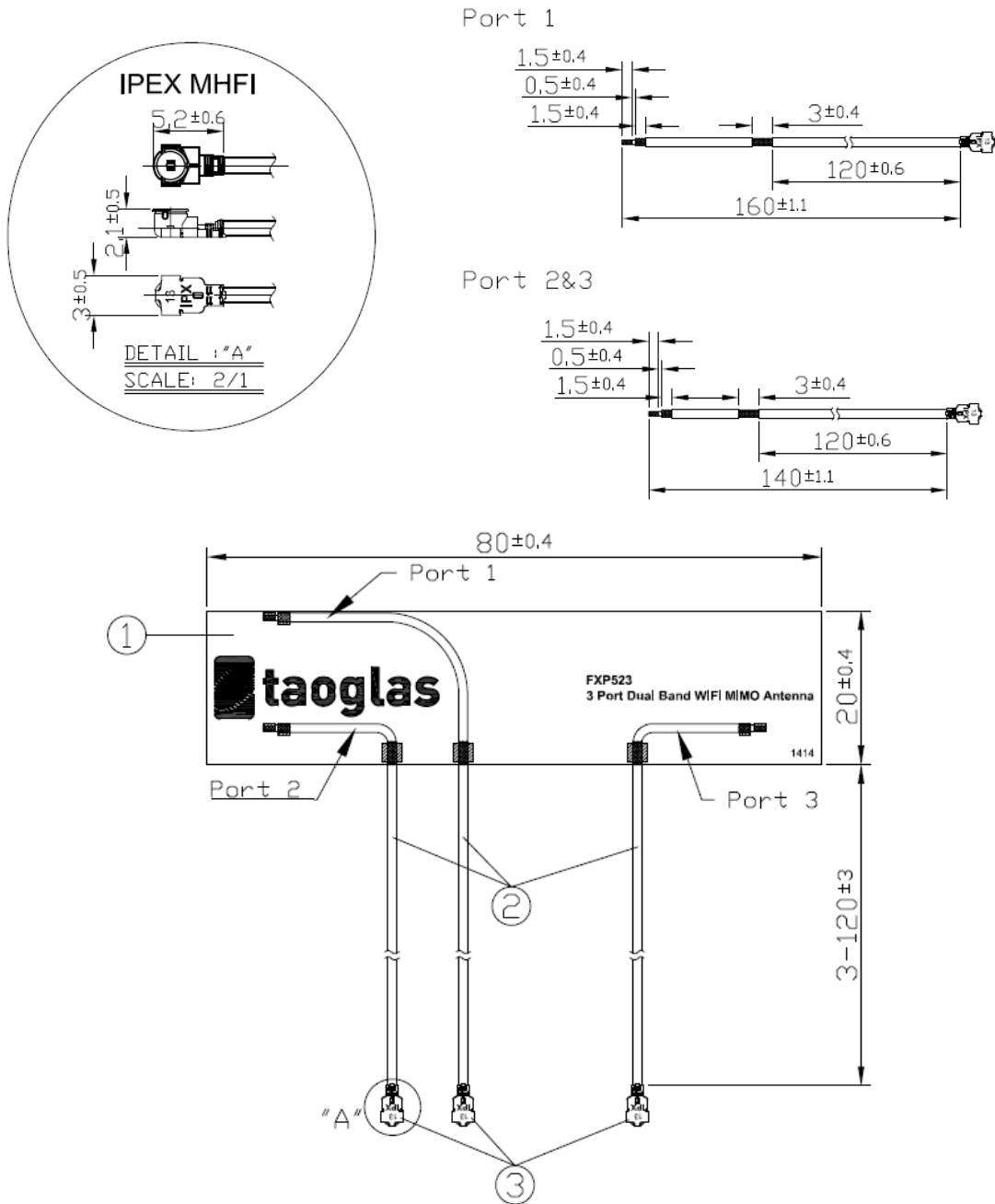

|   | Name               | Material  | Finish | QTY |
|---|--------------------|-----------|--------|-----|
| 1 | FXP523 FPCB        | FR4 0.15t | Black  | 1   |
| 2 | 1.13 Coaxial Cable | FEP       | Black  | 3   |
| 3 | IPEX MHFI 1.13     | Brass     | Gold   | 3   |

## 7. Packaging

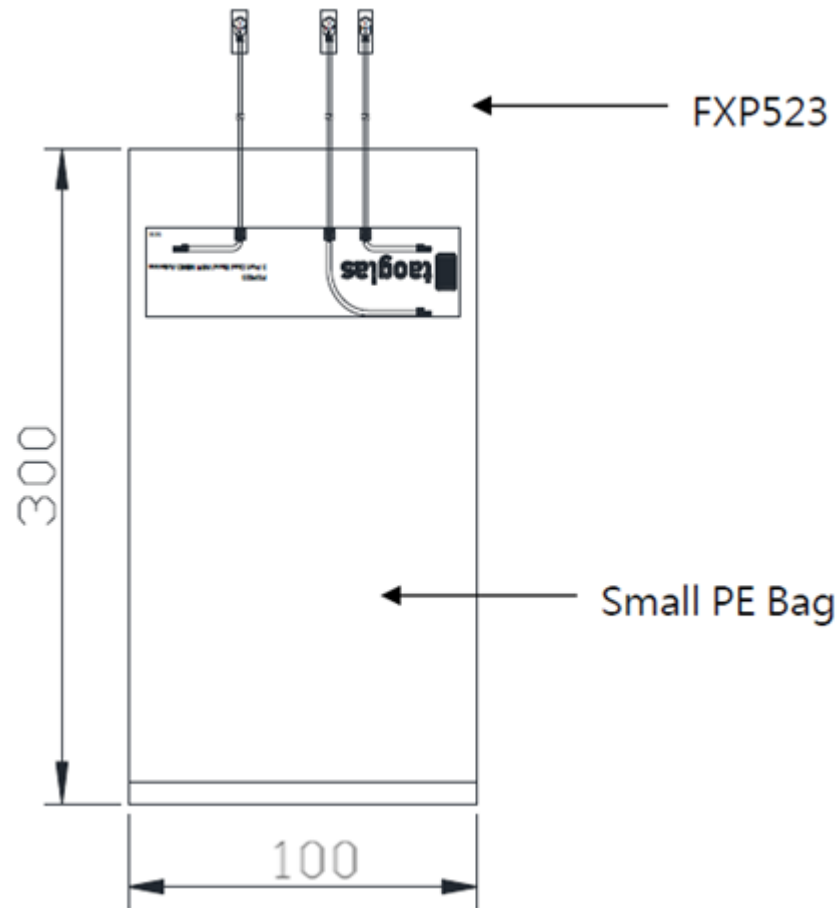

Unit:mm

10 pieces per a small PE Bag