



TAOGLAS®



Datasheet

5.9GHz C-V2X Antenna

Part No:
DCPP.25A.07.0150E

Description:

5.9GHz C-V2X PTFE Patch Antenna on PCB board 30*30mm with 150mm RG-178 & IPEX MHFI 4.2dBi

Features:

5.9GHz C-V2X Ceramic Patch Antenna

5850MHz to 5925MHz

2.4dBi Gain

Cable: 150mm RG-178

Connector: IPEX MHFI

Dimensions: 30*30*5mm

Manufactured in an IATF16949 Approved Facility

ISO16750 Automotive Reliability Tested

RoHS & REACH Compliant

1. Introduction	3
2. Specifications	4
3. Antenna Characteristics	5
4. 2D Radiation Patterns	9
5. 3D Radiation Patterns	11
6. Mechanical Drawing	12
7. Packaging	13
<hr/>	
Changelog	14

Taoglas makes no warranties based on the accuracy or completeness of the contents of this document and reserves the right to make changes to specifications and product descriptions at any time without notice. Taoglas reserves all rights to this document and the information contained herein.

Reproduction, use or disclosure to third parties without express permission is strictly prohibited.



1. Introduction



The DCPP.25A is a 25*25*4mm PTFE patch antenna, designed to operate at 5850-5925MHz for C-V2X (& DSRC) systems. This antenna features high efficiency and circular polarization to enable a more stable system signal strength on moving vehicles where orientation is constantly changing.

Custom patch tuning is available to optimize to specific device environments, including off-center positioning or different ground plane sizes, subject to NRE and MOQ. The DCPP.25A is manufactured in an IATF16949 approved facility. Contact your regional Taoglas office for this and other support with integration and testing of antenna performance in your device.

C-V2X is the communications medium of choice for active safety V2V/V2X (Vehicle-to-Vehicle and Vehicle-to-Other) systems. Primarily allocated for vehicle safety applications, C-V2X supports high-speed, low-latency, short-range, V2V/V2X wireless communications.

For further optimization to customer-specific device environments and for support to integrate and test this antennas performance in your device, contact your regional Taoglas Customer Services Team

2. Specifications

DSRC Antenna *	
Frequency	5850~5925MHz
Efficiency	46.88%
Peak Gain	4.2 dBi
Average Gain	-3.29 dBi
Return Loss	<-6 in band
Polarization	RHCP
Axial Ratio	< 2 at zenith
Impedance	50 Ohms
Mechanical	
Dimensions	30*30*5mm
Cable	150mm RG-178
Connector	IPEX MHFI
Weight	9.3g
Environmental	
Operating and Storage Temperature	-40°C to 85°C
Humidity	Non-condensing 65°C 95% RH

3. Antenna Characteristics

3.1 Return Loss

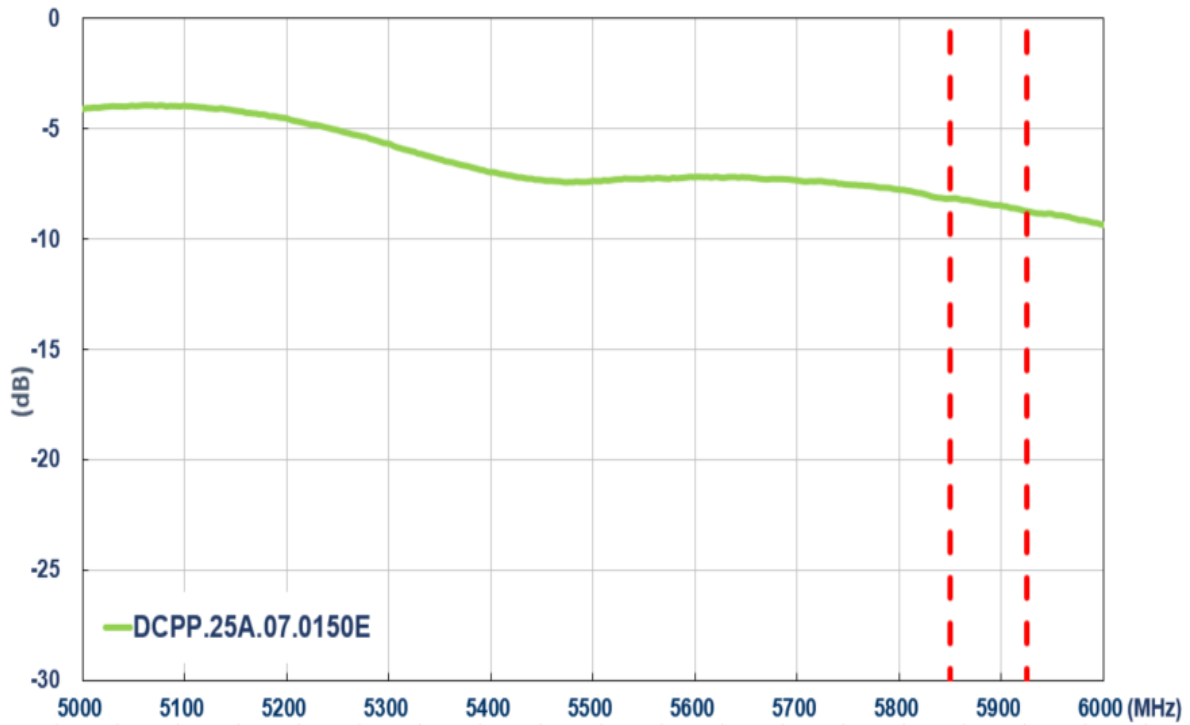

3.2 Efficiency

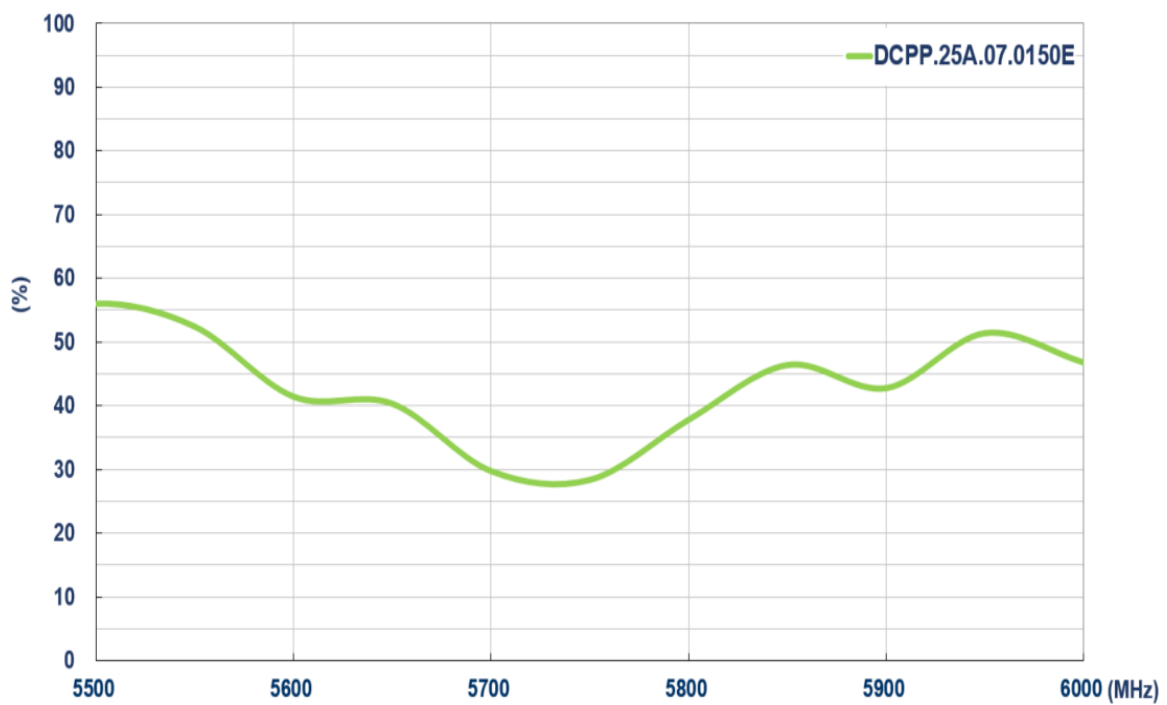

3.3 Average Gain

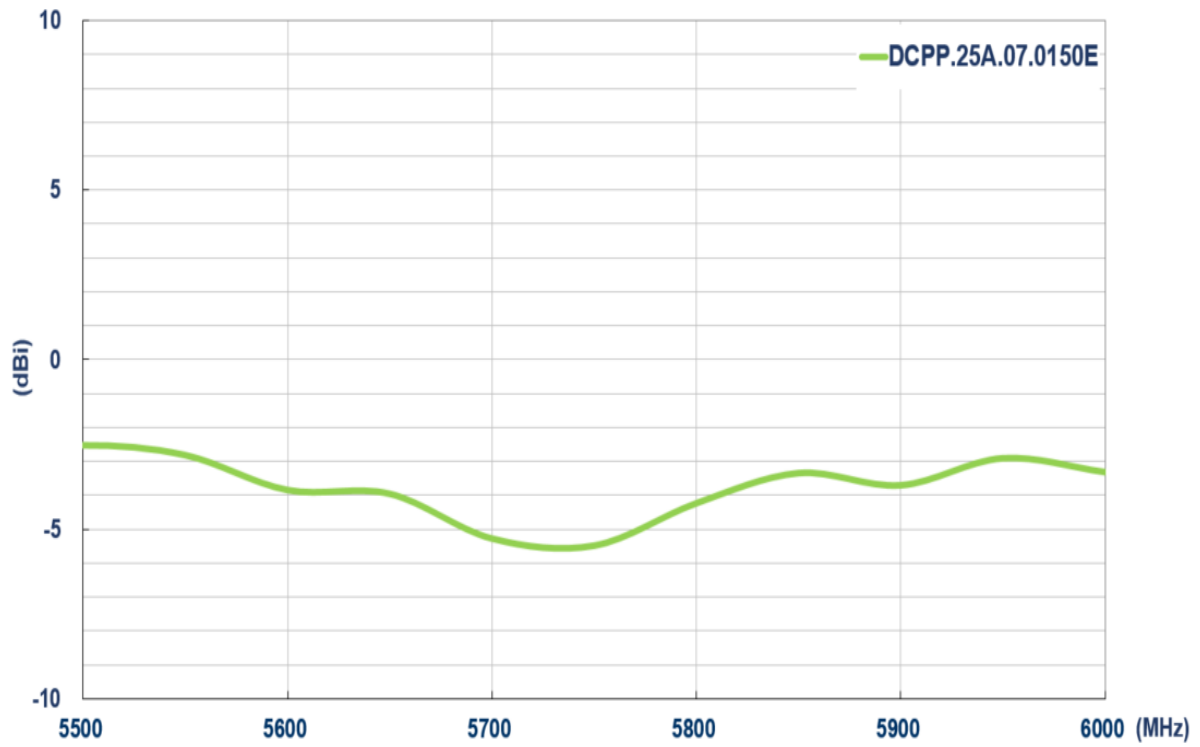

3.4 Peak Gain

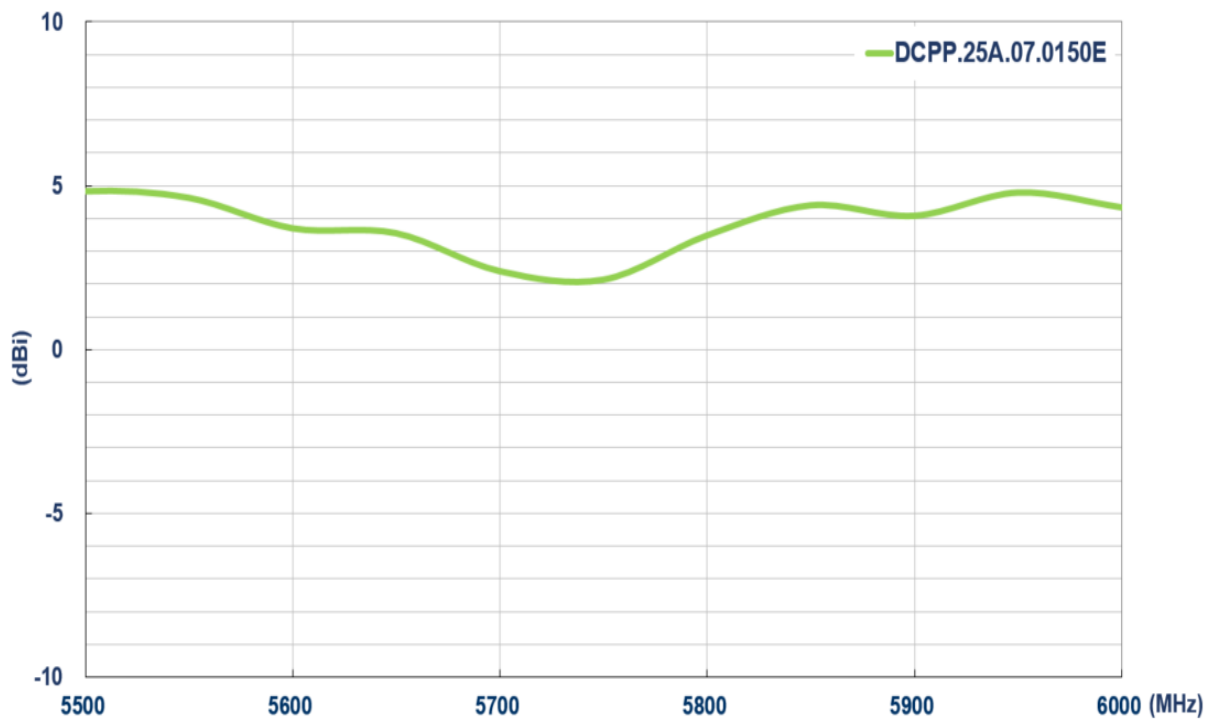

3.5 Axial Ratio – 5850MHz

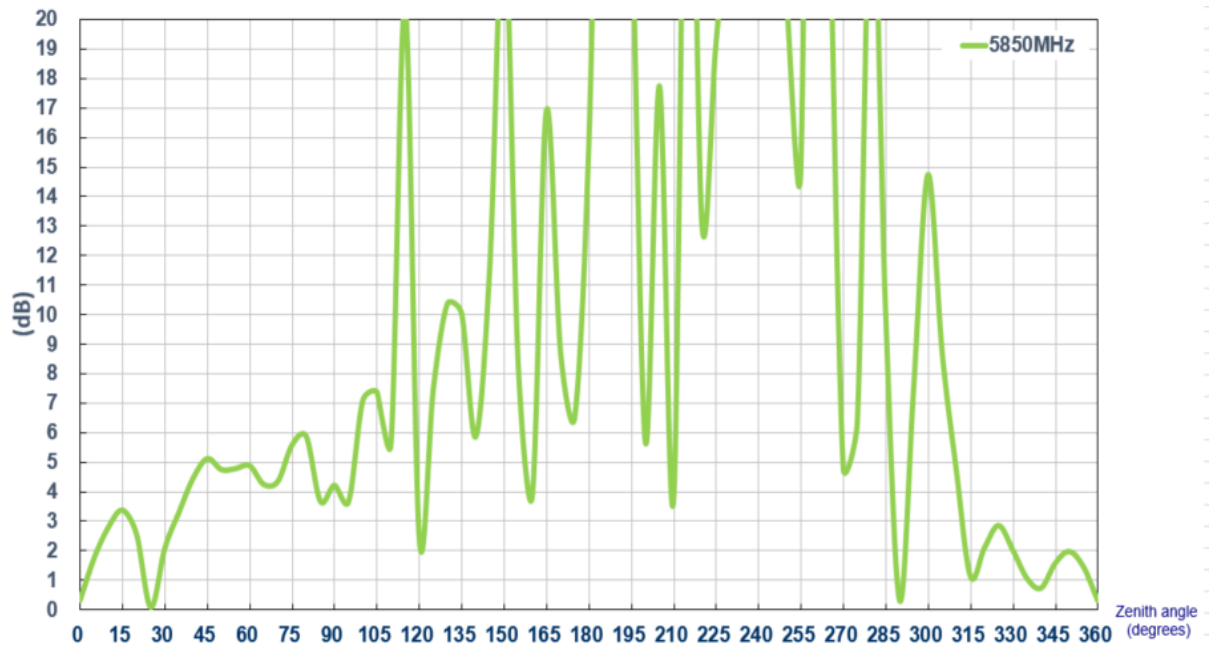

3.6 Axial Ratio – 5900MHz

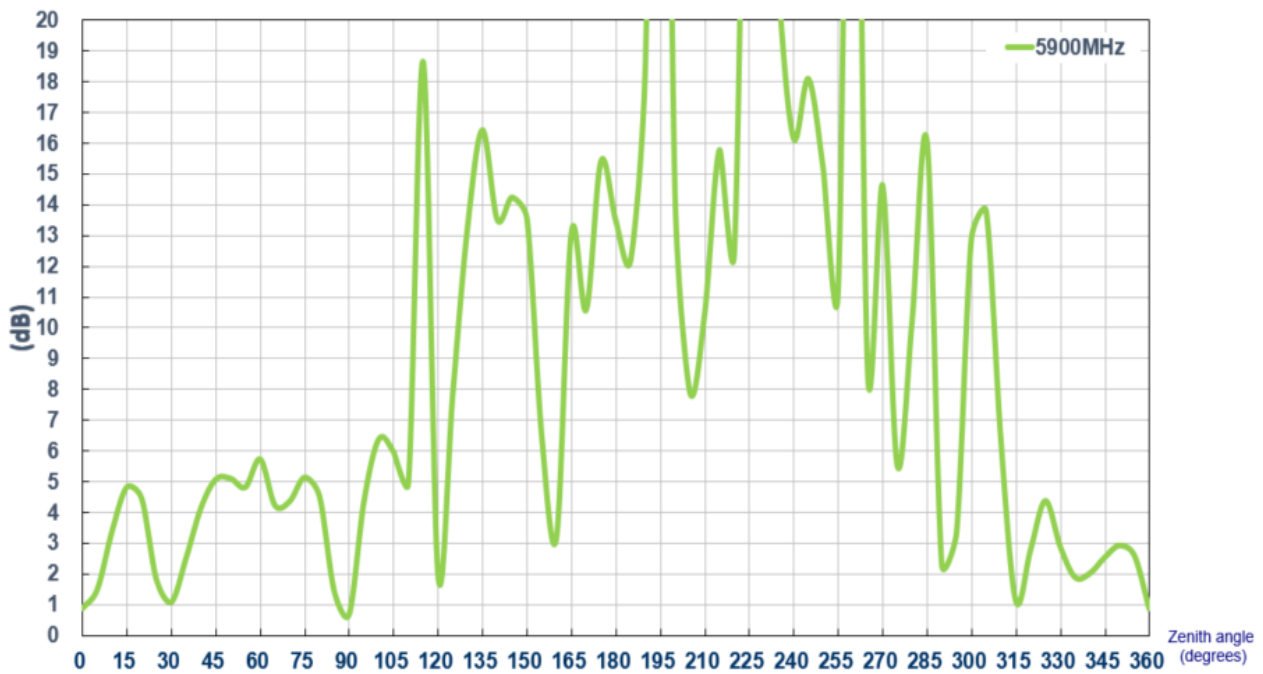

3.7 Axial Ratio – 5925MHz

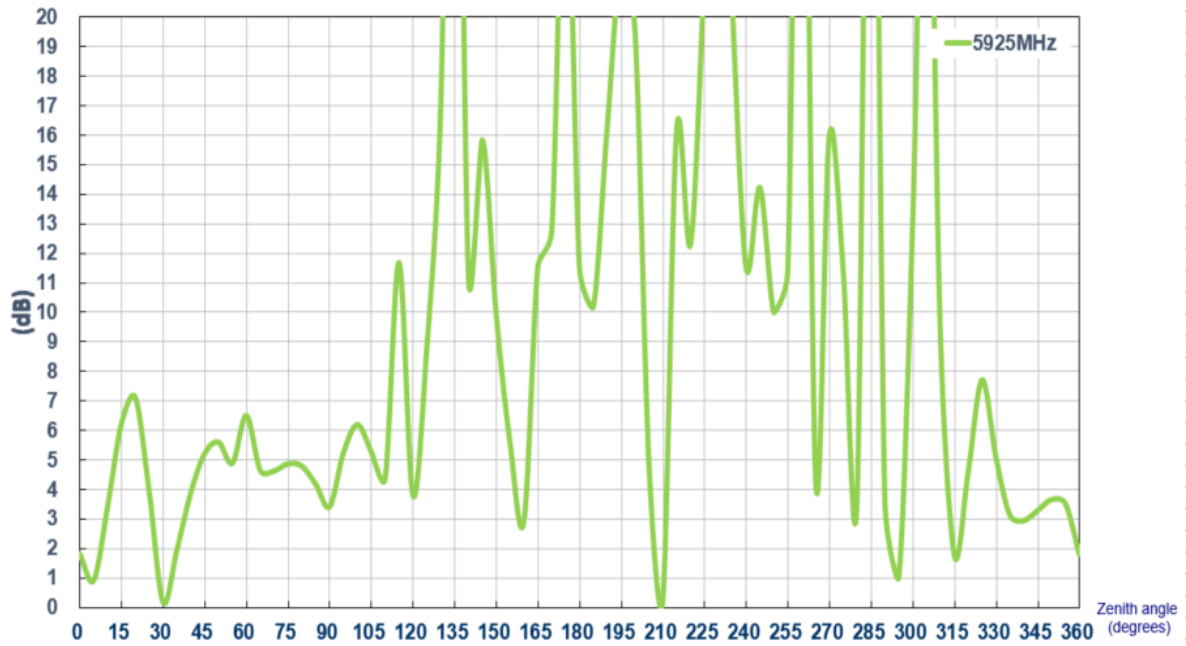

0° is toward Zenith

4. 2D Radiation Patterns

4.1 Test Setup

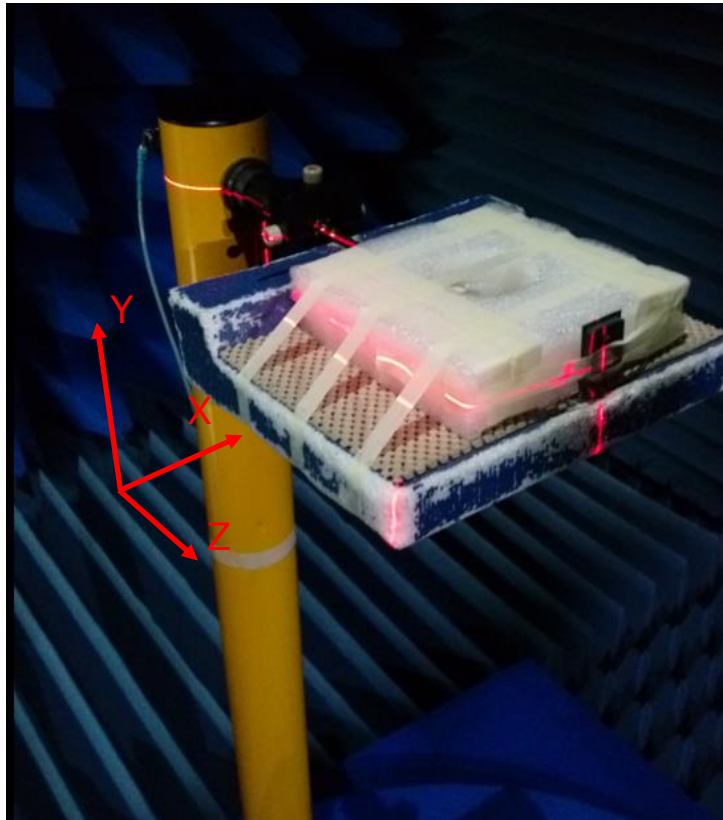

Free space

XY Plane

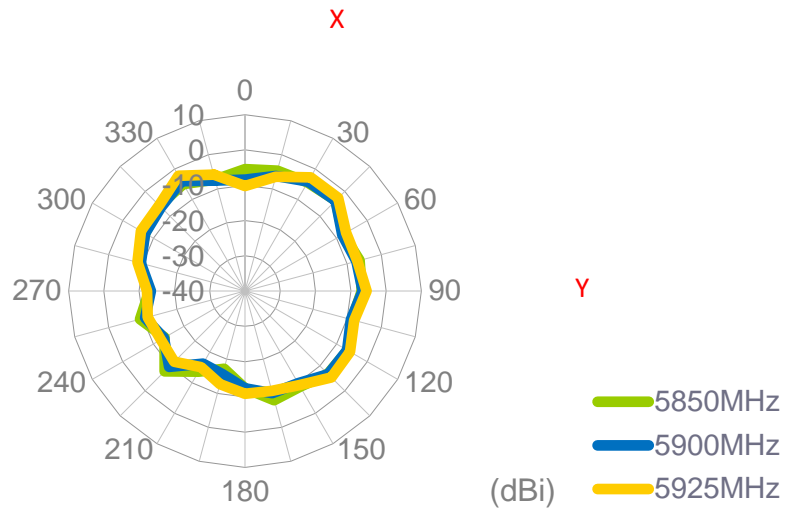

XZ Plane

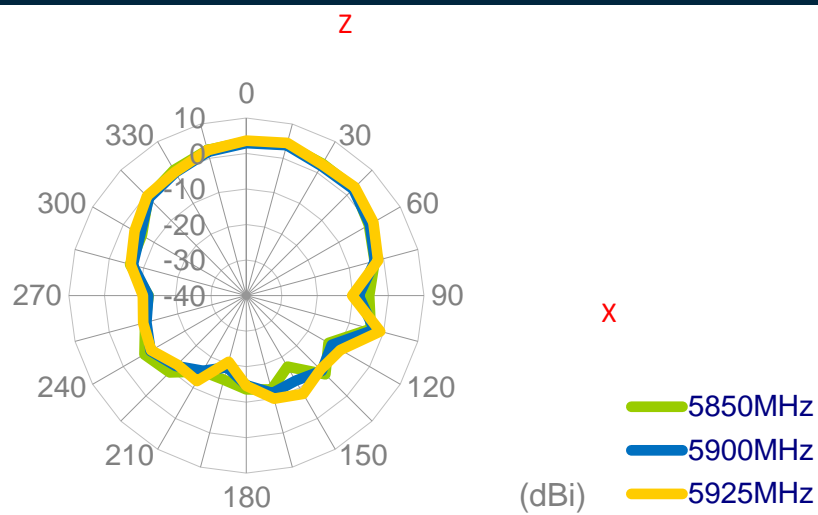

YZ Plane

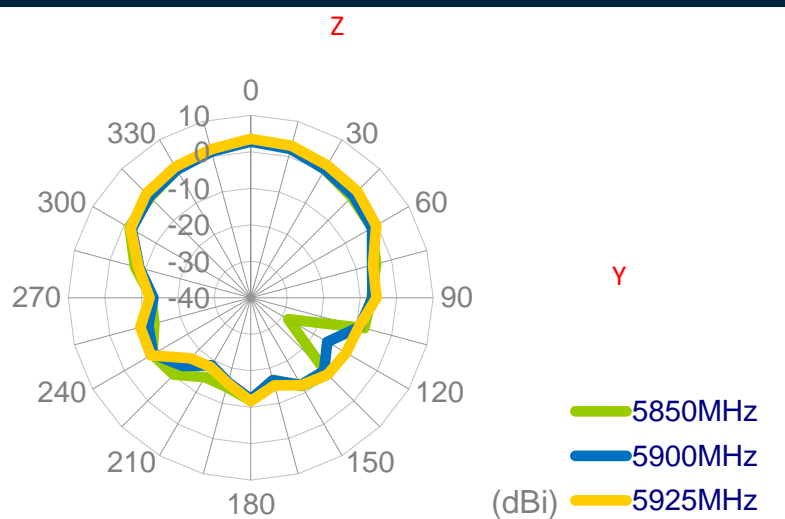

5. 3D Radiation Patterns

5.1 Free Space

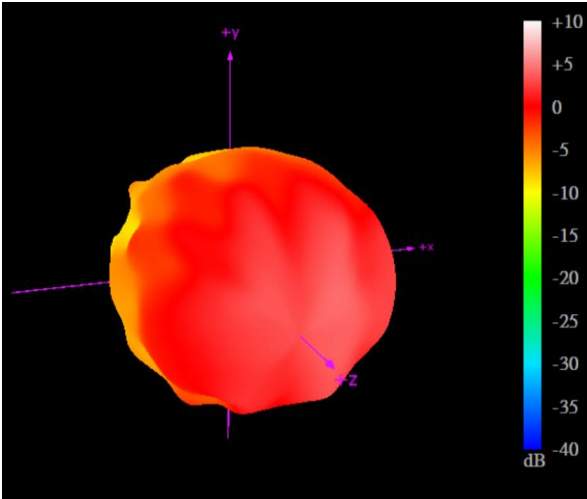

5850MHz

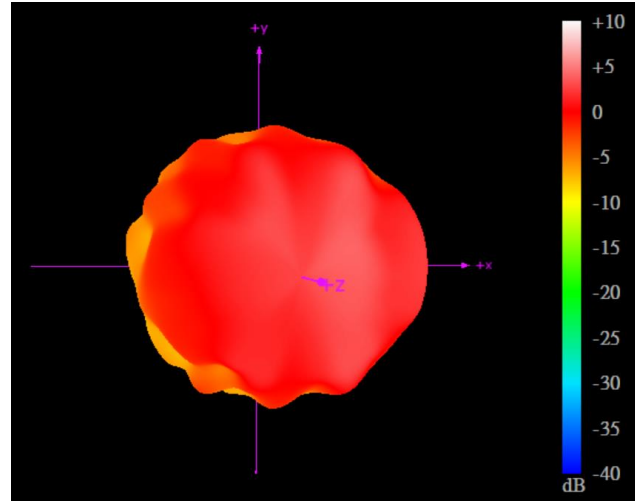

5900MHz

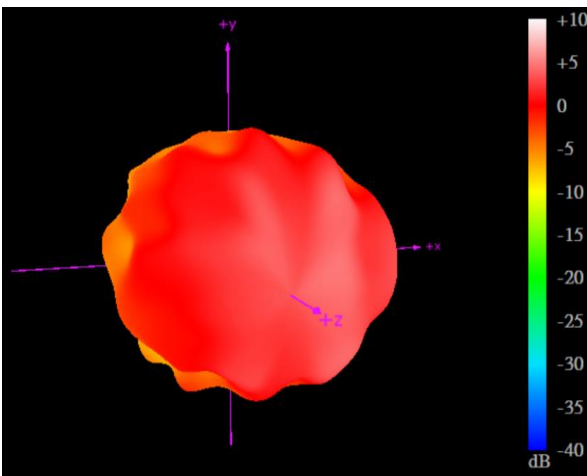

5925MHz

6. Mechanical Drawing (Units: mm)

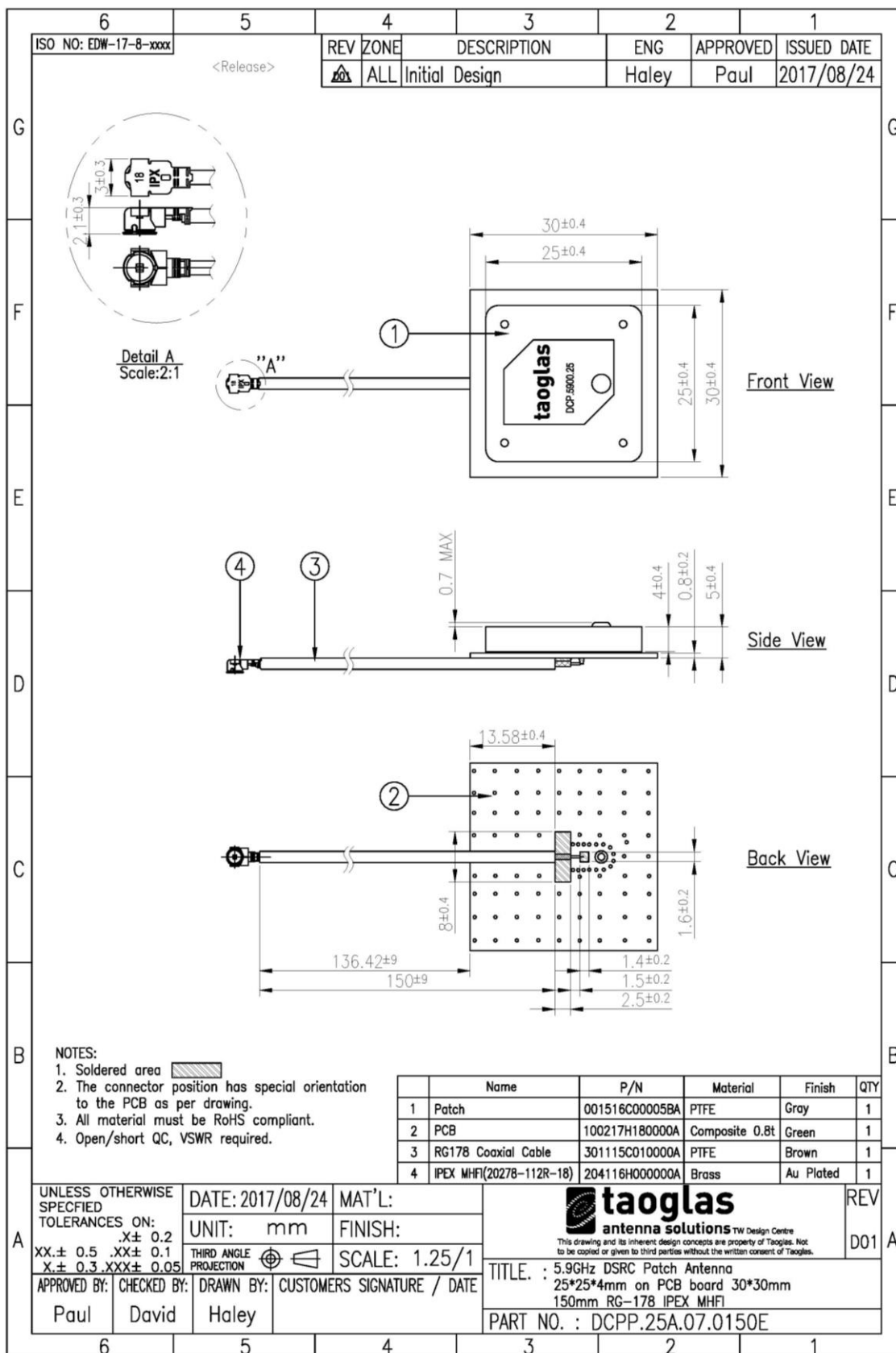

7. Packaging

1pc DCP.25A.07.0150E per small PE bag
 Bag Dimensions - 180*120 mm
 Weight - 10.5g

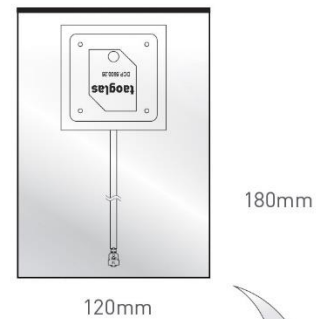

200pcs DCP.25A.07.0150E per carton
 Carton Dimensions - 485*640*130mm
 Weight - 3.6Kg

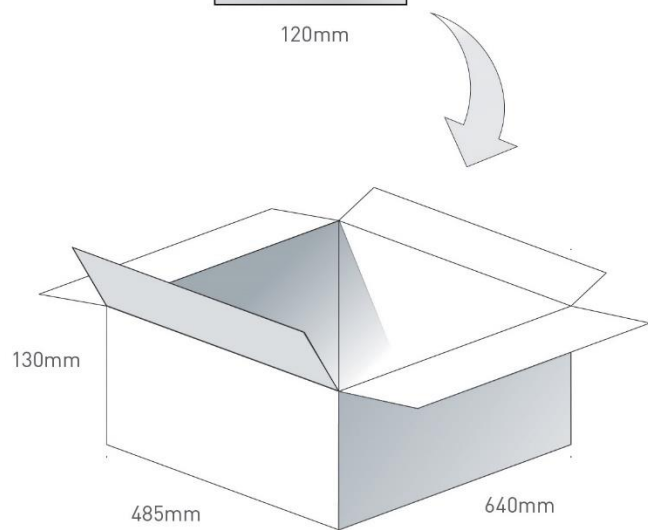

Pallet Dimensions 1200mm*1000mm*1500mm
 20 Cartons per Pallet
 2 Cartons per layer
 10 Layers

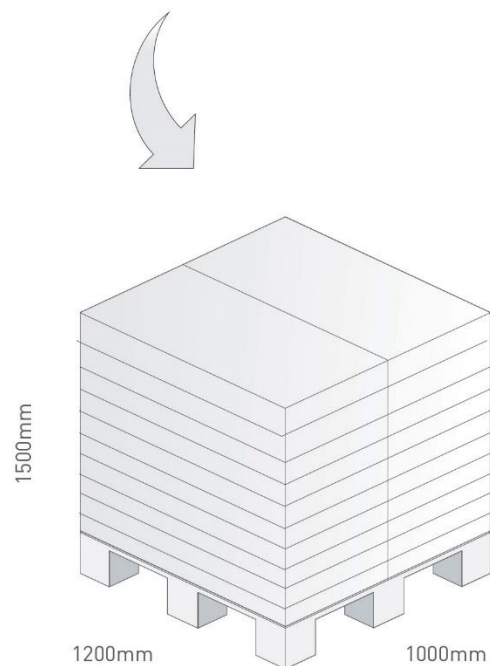

Changelog for the datasheet

SPE-18-8-051 – DCP.P.25A.07.0150E

Revision: C (Current Version)	
Date:	2019-10-25
Changes:	Updated to Include C-V2X
Changes Made by:	Jack Conroy

Previous Revisions

Revision: B	
Date:	2019-05-10
Changes:	Data Amended and Format updated
Changes Made by:	Jack Conroy

Revision: A (Original First Release)	
Date:	2018-04-27
Notes:	
Author:	Jack Conroy



TAOGLAS®

www.taoglas.com

