



TAOGLAS®



Datasheet

Part No:
AA.180.501111

Description:
Compact Low Axial Ratio
Magnetic Mount Antenna

Features:
Magnetic Mount
IP67 Rated Enclosure
Covers:

- GPS/QZSS (L1)
- Galileo (E1)
- GLONASS (G1)
- BeiDou (B1)

Cable: 5m RG-174
Connector: SMA(M)
Cable and Connector Customizable
Dimensions: 35 x 35 x 15mm
RoHS & Reach Compliant

1.	Introduction	3
2.	Specifications	4
3.	Antenna Characteristics	6
4.	Radiation Patterns	10
5.	Active Characteristics	14
6.	Field Test Results	16
6.	Mechanical Drawing	17
7.	Packaging	18
8.	Pull Force test	19
<hr/>		
	Changelog	21

Taoglas makes no warranties based on the accuracy or completeness of the contents of this document and reserves the right to make changes to specifications and product descriptions at any time without notice. Taoglas reserves all rights to this document and the information contained herein. Reproduction, use or disclosure to third parties without express permission is strictly prohibited.



1. Introduction



The compact AA.180 magnetic mount external antenna is ideal for robust, covert installations where durability and small size is paramount. This low-profile antenna is tuned for stable operation over GPS-GLONASS-Galileo- BeiDou L1/E1/B1 frequency bands and is used in a wide range of applications where GNSS services are required. At only 35mm square and 15mm in height, it is the most compact high accuracy antenna in the market for L1 operation.

Typical Applications include:

- Advanced telematics and M2M applications
- Fleet management
- High accuracy positioning systems

Integration of a Taoglas Dual-pin patch enables the axial ratio to be 3 at the center of the band, delivering good right hand circular polarization, which increases location accuracy and speed of time to first fix in the GNSS system. A front-end SAW reduces out-of-band interference from any nearby wireless transmitters, helping prevent LNA compression and burnout.

Standard cable and connector version is 5 meters of RG-174 with SMA(M). Cable length and connector type are customizable upon request. For further information, contact your regional Taoglas customer support team.

2. Specifications

GNSS Frequency Bands Covered						
GPS	L1	L2	L5			
	■	□	□			
GLONASS	G1	G2	G3			
	■	□	□			
Galileo	E1	E5a	E5b	E6		
	■	□	□	□		
BeiDou	B1	B2a	B2b	B3		
	■	□	□	□		
QZSS (Regional)	L1	L2C	L5	L6		
	■	□	□	□		
IRNSS (Regional)	L5					
	□					
SBAS	L1/E1/B1	L5/B2a/E5a	G1	G2	G3	
	■	□	■	□	□	

■ GNSS Frequency Bands Covered. □ GNSS Frequency Bands Not Covered.

*SBAS systems: WASS(L1/L5), EGNOS(E1/E5a), SDCM(G1/G2/G3), SNAS(B1,B2a), GAGAN(L1/L5), QZSS(L1/L5), KAZZ(L1/L5).

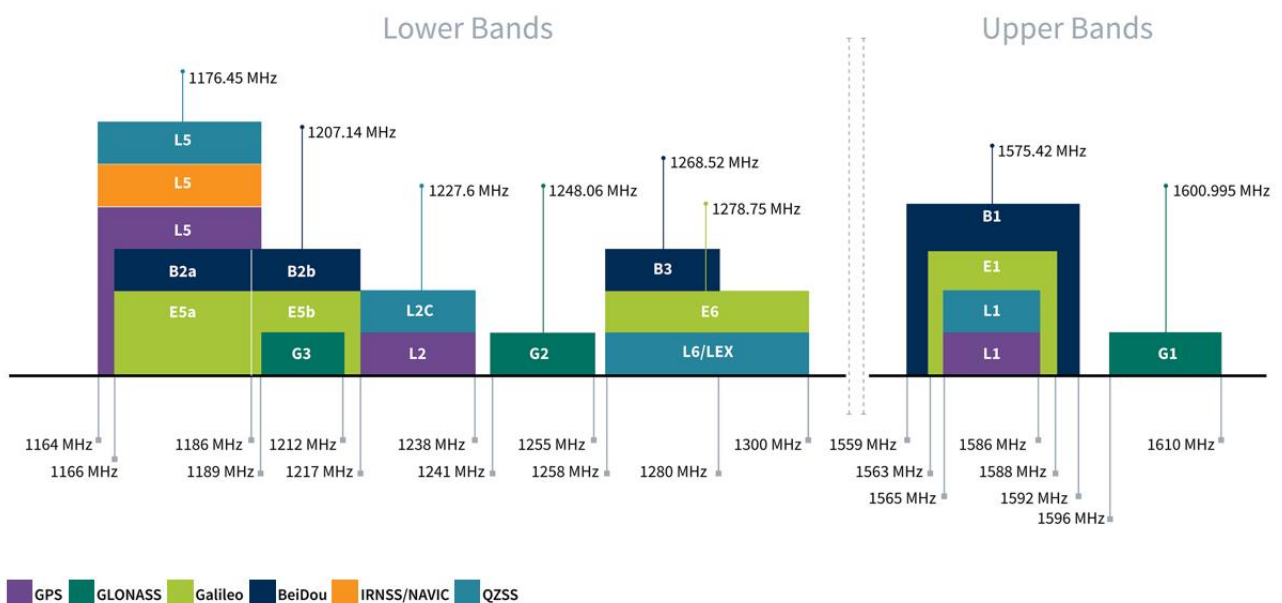

GNSS Bands and Constellations

GNSS Electrical			
Frequency (MHz)	1561	1575.42	1602
Return Loss (dB)	-30	-18	-13
Efficiency (%)	59.4	51.4	35.1
Peak Gain at Zenith (dBi)	3.31	2.71	1.08
Group Delay	20	20	20
PCO (cm)	3.7	3.7	3.7
PCV (cm)	2	2	2
Polarization	RHCP		
Impedance(Ω)	50		

LNA and Filter Electrical Properties			
Frequency (MHz)	1561	1575.42	1602
Return Loss(dB)	<-10	<-10	<-10
Gain@1.8V (dB Typ.)	31.3	30.2	2.7
Gain@3.0V (dB Typ.)	33.1	32.5	32.0
Gain@5.5V (dB Typ.)	33.5	33.0	33.1
Noise@1.8V (dB Typ.)	3.1	2.7	3.1
Noise@3.0V (dB Typ.)	3.3	2.9	3.3
Noise@5.5V (dB Typ.)	3.3	2.9	3.2
Pout 1dB gain Compression Point	-6dBm Min. -2 dBm Typ(1561MHz,1575.42MHz,1602MHz)		

Total Specification (Through Antenna, SAW Filter and LNA)			
Frequency (MHz)	1561	1575.42	1602
Gain@3V (dBi)	26.1 dBi	27.6 dBi	27 dBi
Output Impedance	50 Ω		

Mechanical	
Dimensions	35 x 35 x 15mm
Connector	SMA(M) fully customizable
Cable	5 meter RG174 standard, fully customizable
Weight	92g

Environmental	
IP Rating	IP67
Temperature Range	-40°C to 85°C
Humidity	Non-condensing 65°C 95% RH
Cable Pull	Pull horizontal max pull force(kgf): 0.52 Pull vertical max pull force(kgf): 0.48

3. Antenna Characteristics

3.1 Return Loss

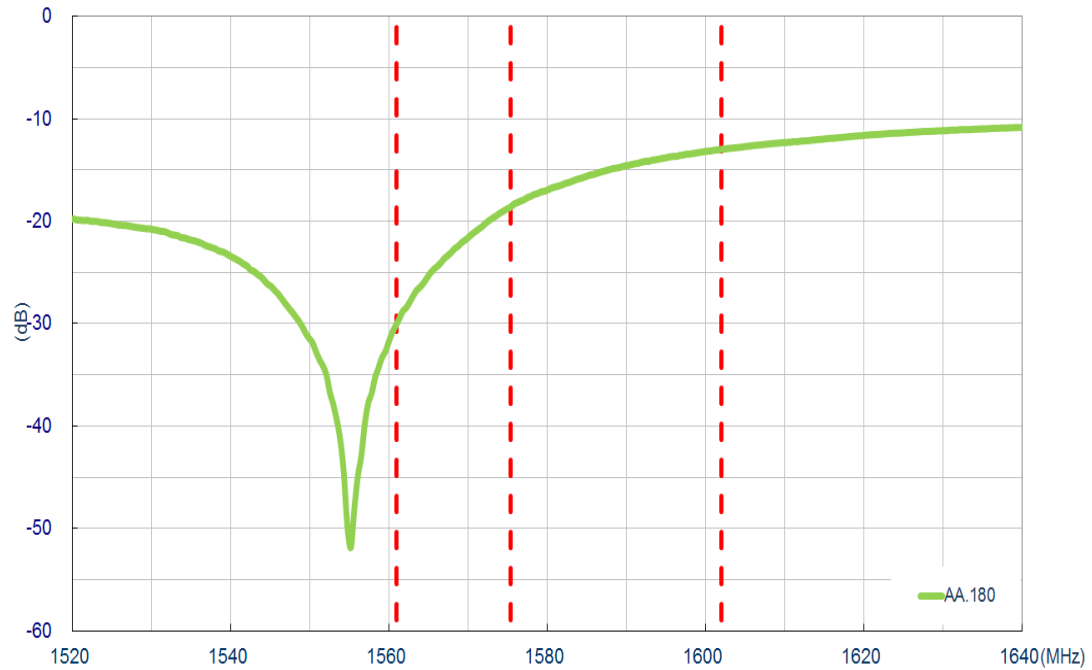

3.2 Efficiency

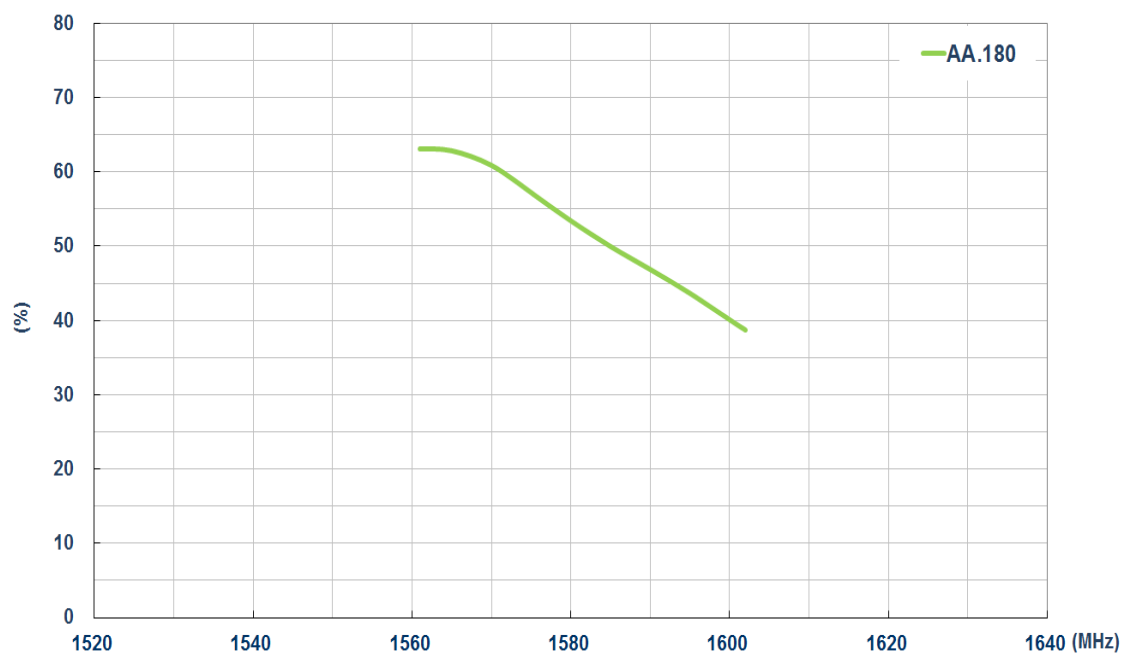

3.3 Average Gain

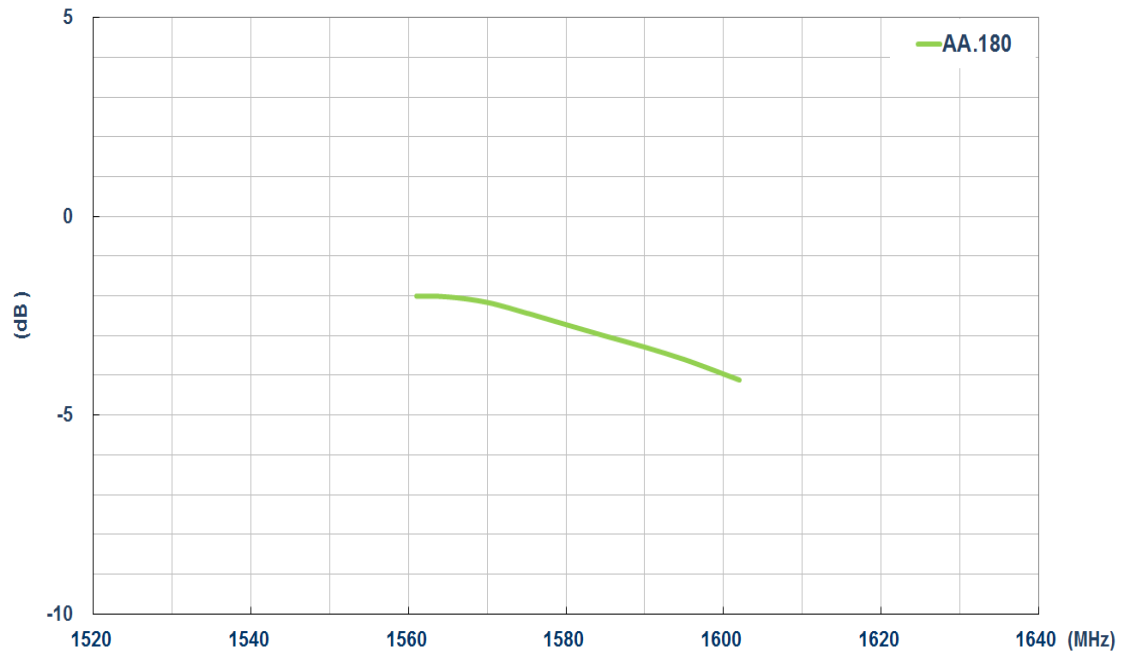

3.4 Peak Gain

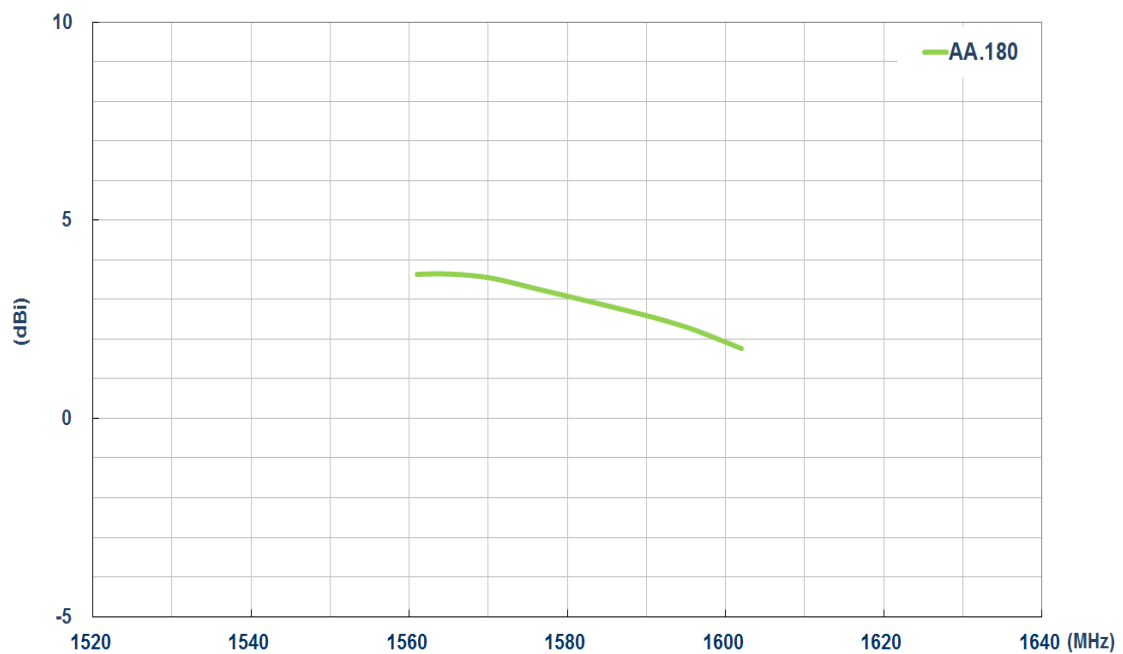

3.5 Axial Ratio @ 1575.42MHz - Phi=0

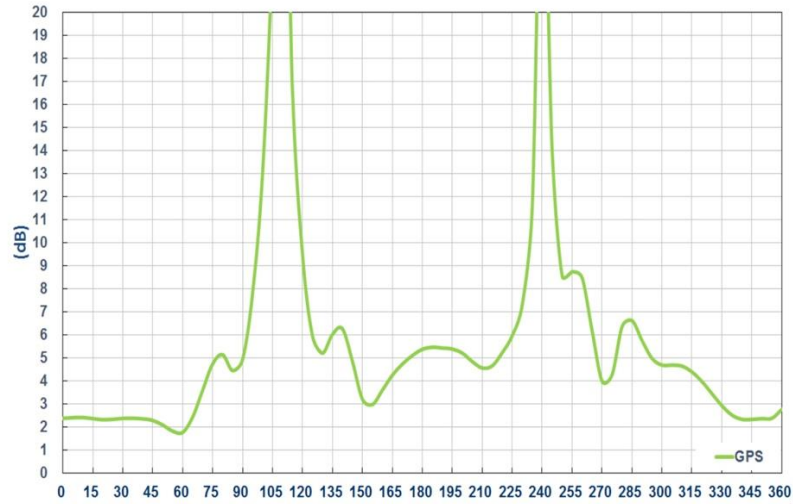

3.6 Axial Ratio @ 1602MHz - Phi=90

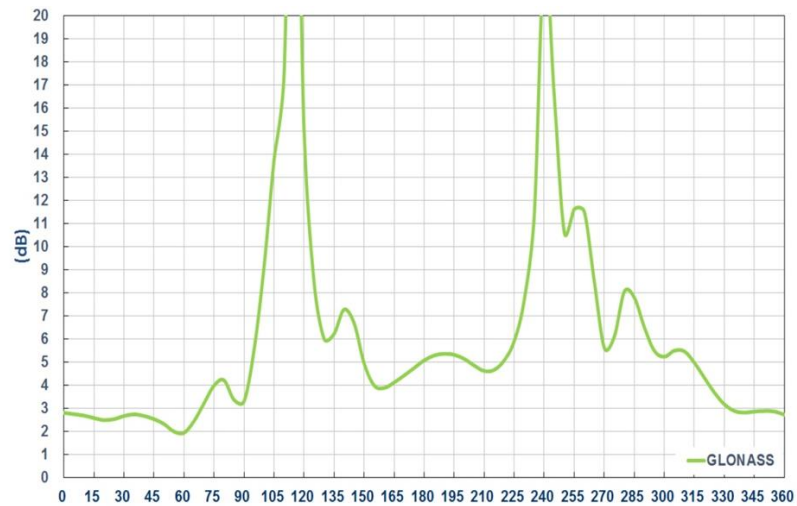

3.7 Axial Ratio @ 1561MHz - Phi=0

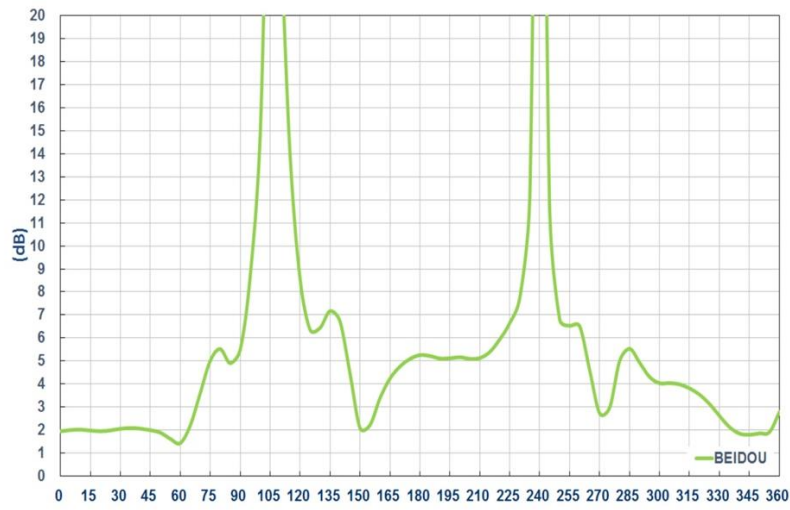

4. Radiation Patterns

4.1 Test Setup



4.2 1561MHz 3D and 2D Radiation Patterns

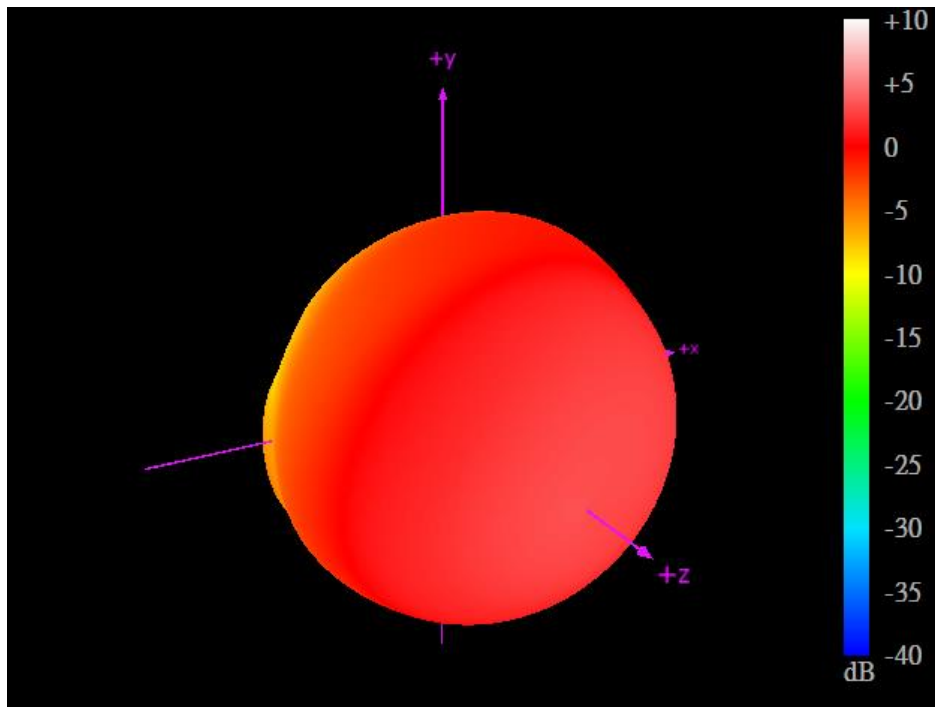

XY Plane

XZ Plane

YZ Plane

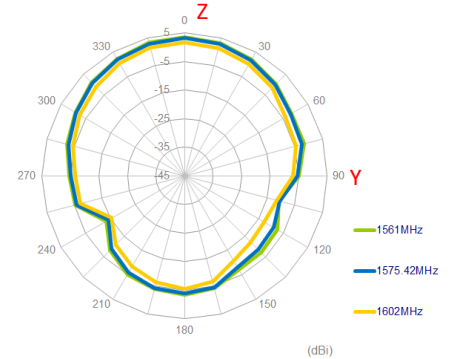
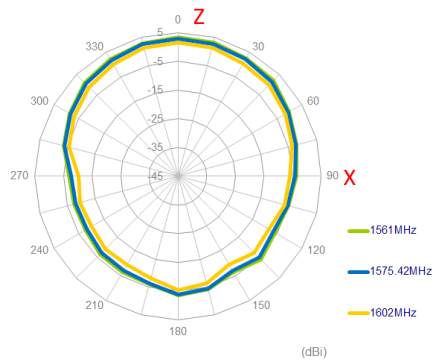
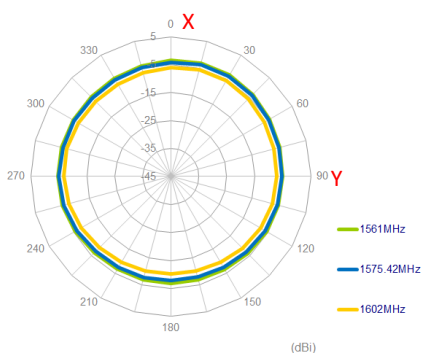

4.3 1575.42MHz 3D and 2D Radiation Patterns

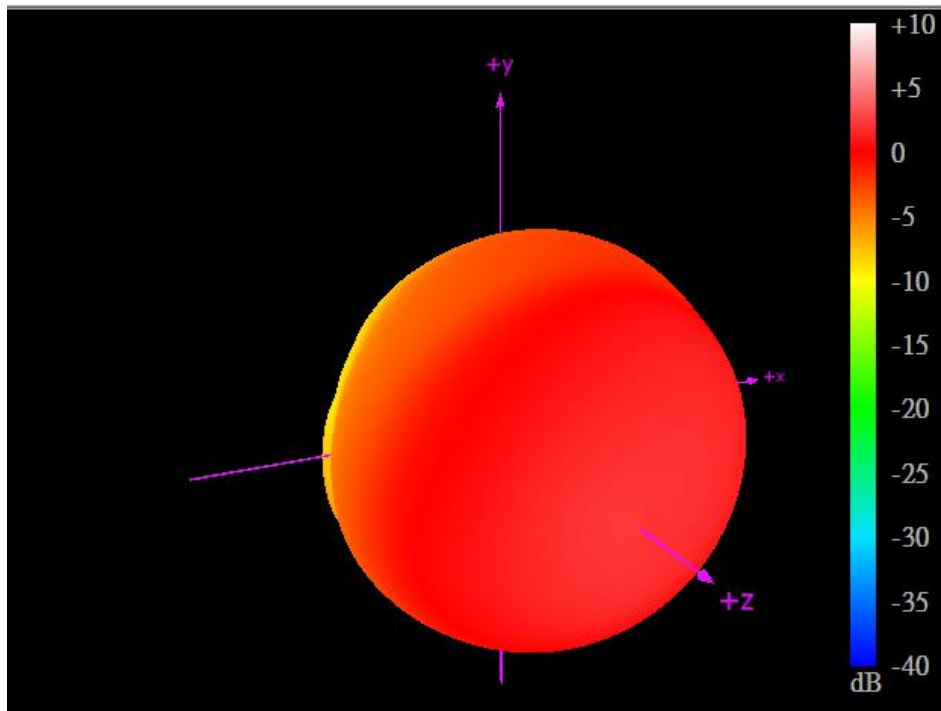

XY Plane

XZ Plane

YZ Plane

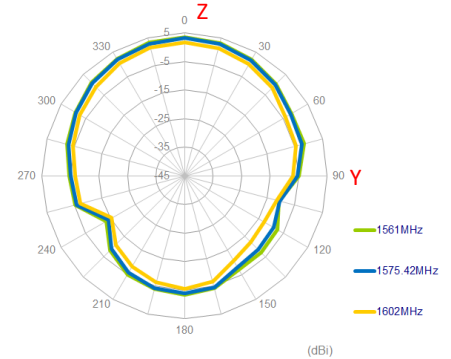
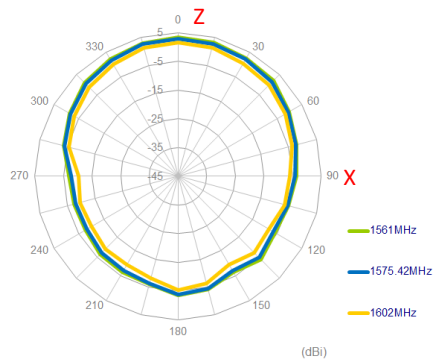
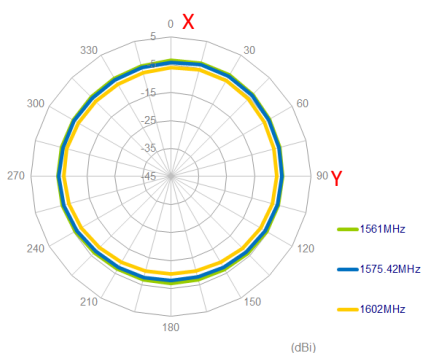

4.4 1602MHz 3D and 2D Radiation Patterns

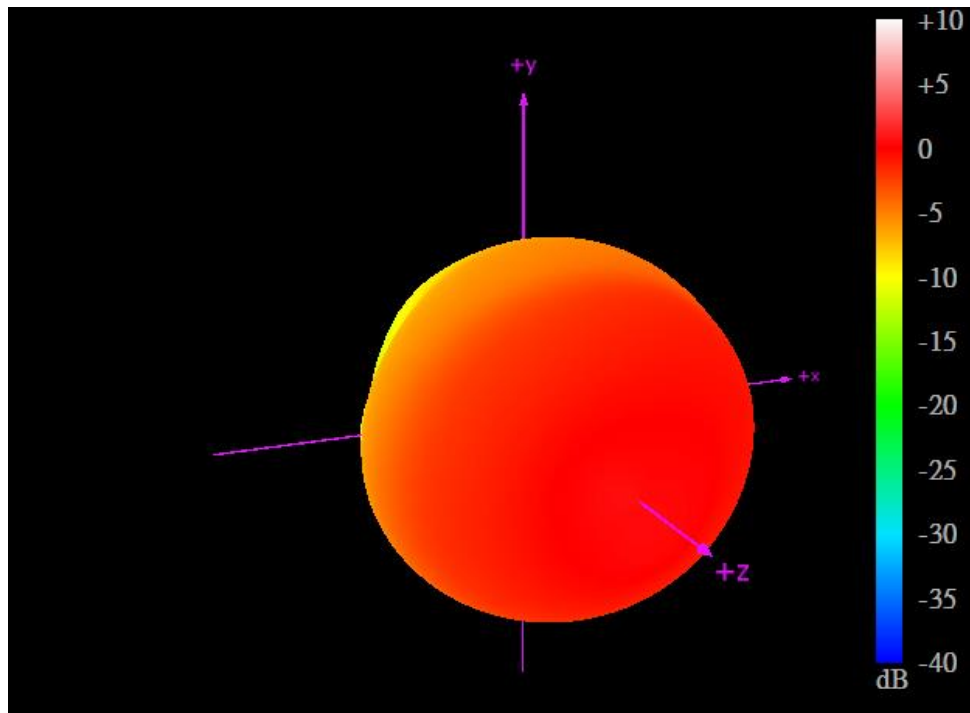

XY Plane

XZ Plane

YZ Plane

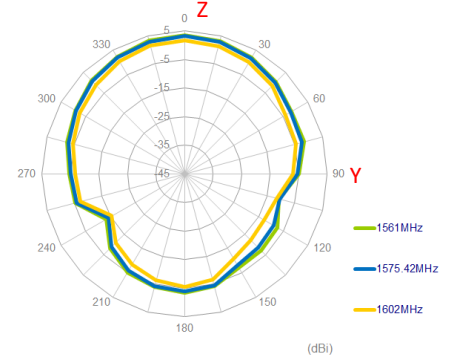
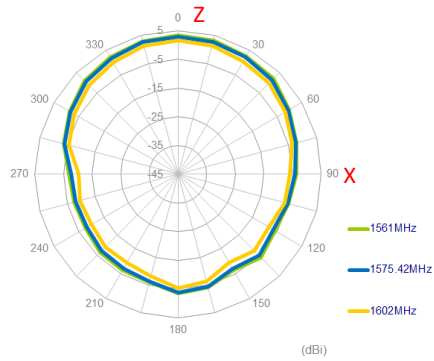
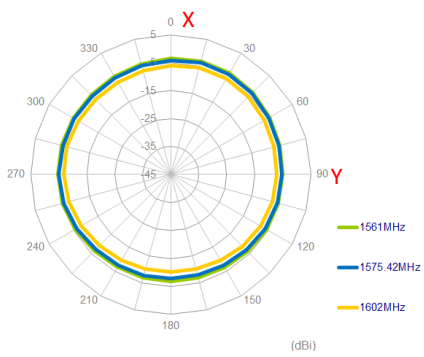

5. Active Characteristics

5.1 Block Diagram (Active Antenna)

GPS + GLONASS + Beidou
Antenna
(Dual Pin Patch)

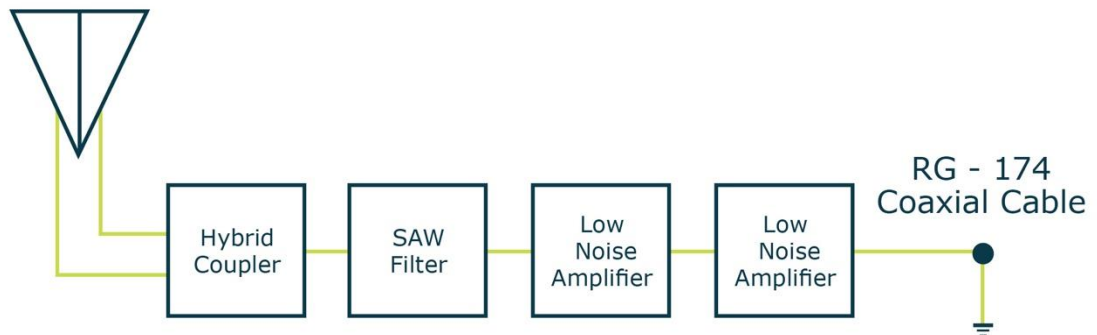

5.2 LNA Gain

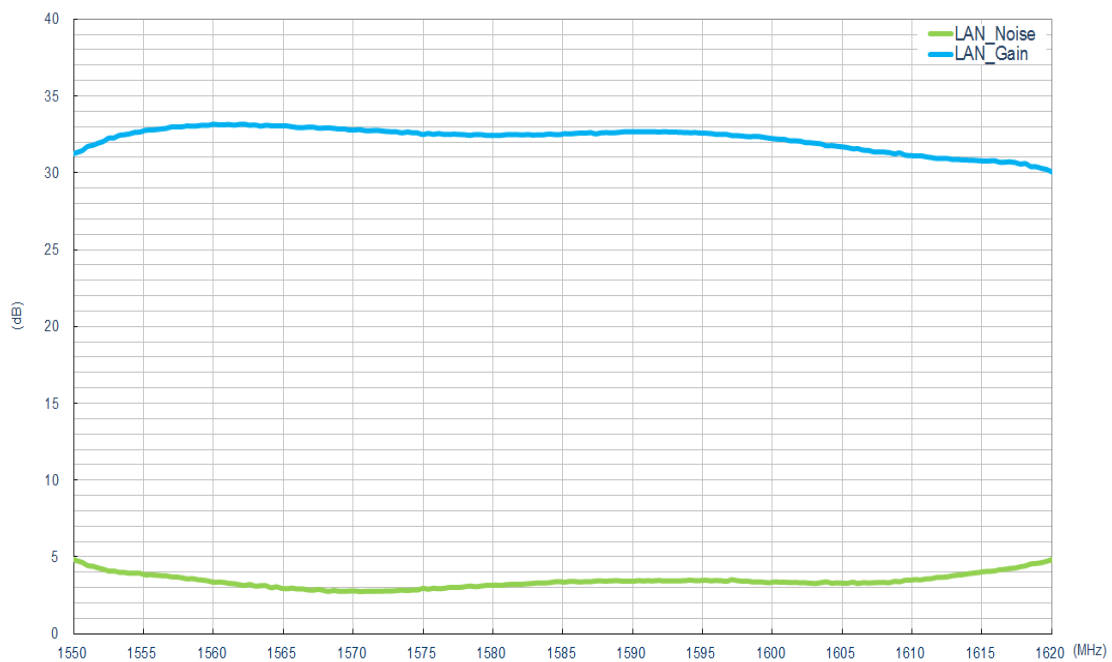

5.3 Out of Band Rejection

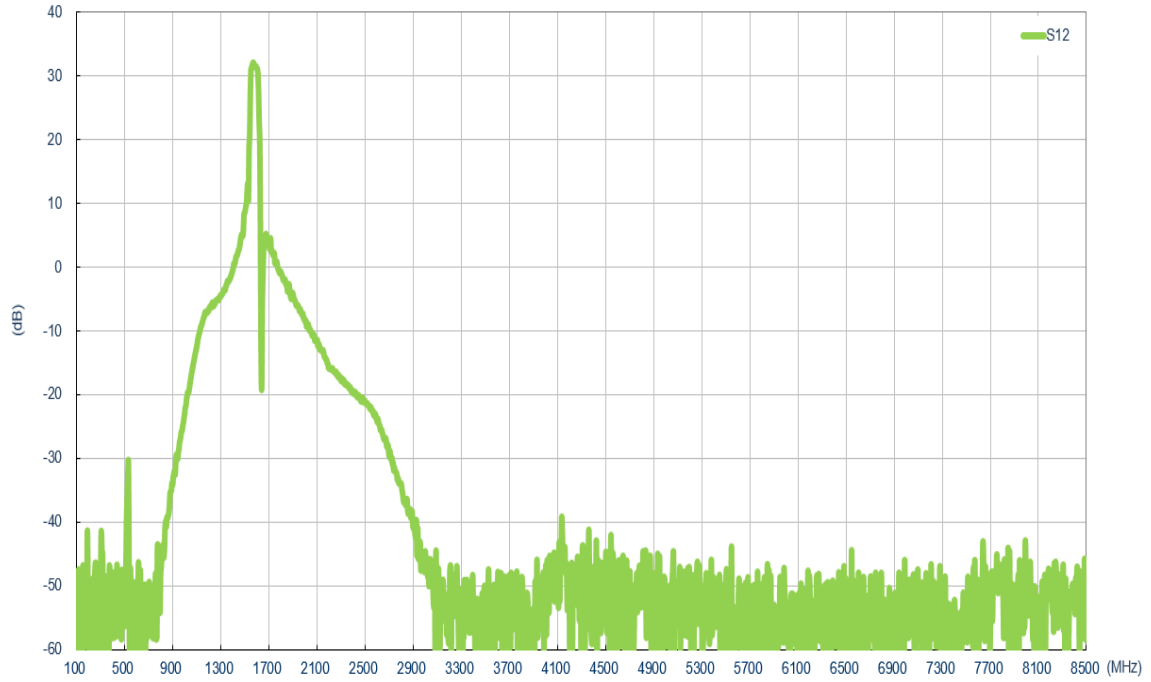

6. Field Test Results

6.1 Rooftop test

In this section Taoglas will present the field test result for AA.180 antenna. The test was performed when the antenna was mounted on a static rooftop test set up in an open sky environment for at least **6 hours**.

Taoglas will show the field test results using the following receiver:

1. U-blox ZED-F9P

Receiver features:

- Multi-band GNSS: 184-channel GPS L1C/A L2C, GLONASS: L1OF L2OF, Galileo: E1B/C E5b, BeiDou: B1I B2I, QZSS: L1C/A L2C
- Multi-band RTK with fast convergence times and reliable performance
- Nav. update rate RTK up to 20 Hz
- Position accuracy = RTK 0.01 m + 1 ppm CEP

Positioning Accuracy Table (2D Accuracy)					
Test Condition	Correction Service	CEP (50%)	DRMS (68%)	2DRMS (95-98.2%)	TTF (sec)
Free Space	RTK DISABLED	79.16 cm	94.75 cm	189.5 cm	22
	RTK ENABLED	1.47 cm	1.81 cm	3.62 cm	22
30x30 cm Ground Plane	RTK DISABLED	74 cm	88.81 cm	177.63 cm	21
	RTK ENABLED	1.15 cm	1.37 cm	2.75 cm	21

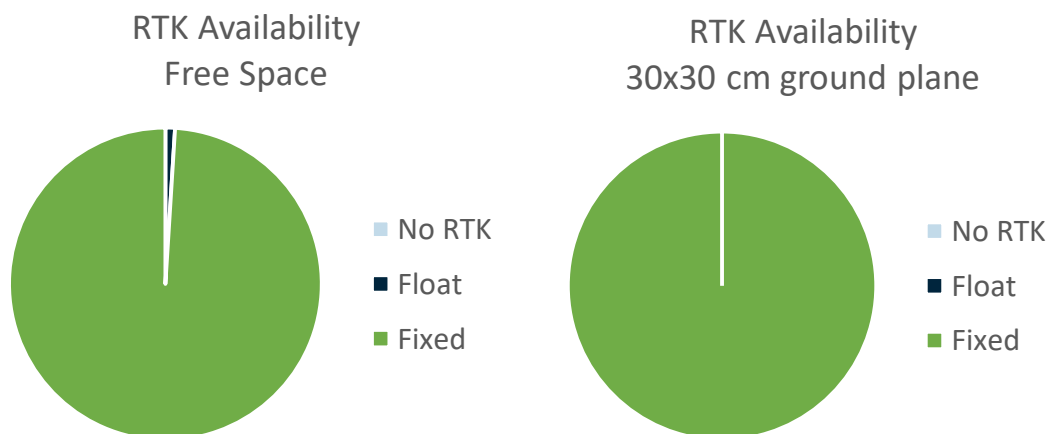

7. Mechanical Drawing (Units: mm)

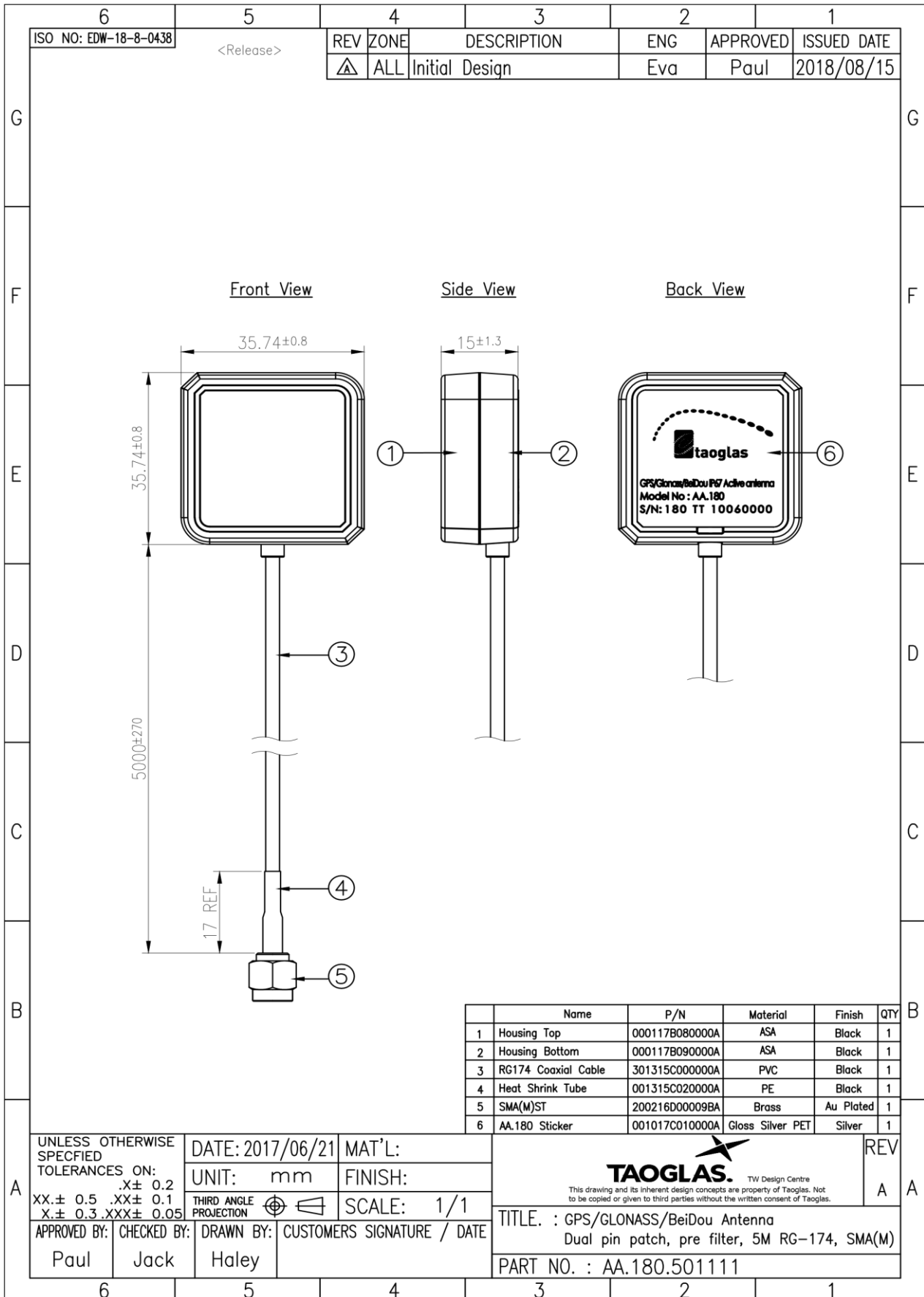

8. Packaging

1 pcs AA.180.501111 per PE Bag
 Bag Dimensions - 100 x 230 mm
 Weight - 97g

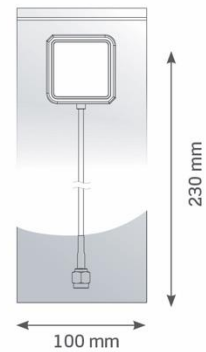

10 pcs AA.180.501111 per PE Large Bag
 Bag Dimensions - 200x 450mm
 Weight - 0.99kg

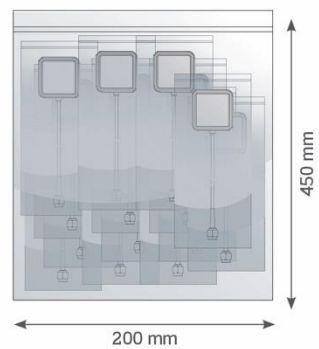

100 pcs AA.180.501111 per carton
 Carton - 370 x 370 x 300mm
 Weight - 10.87Kg

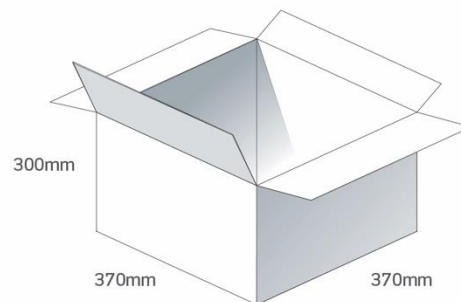

Pallet Dimensions 110x 110 x 140cm
 36 Cartons per Pallet
 9 Cartons per layer
 4 Layers

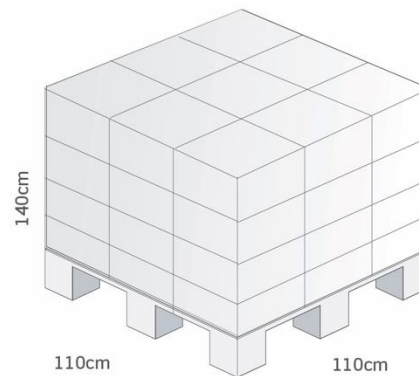

9. Pull Force Test

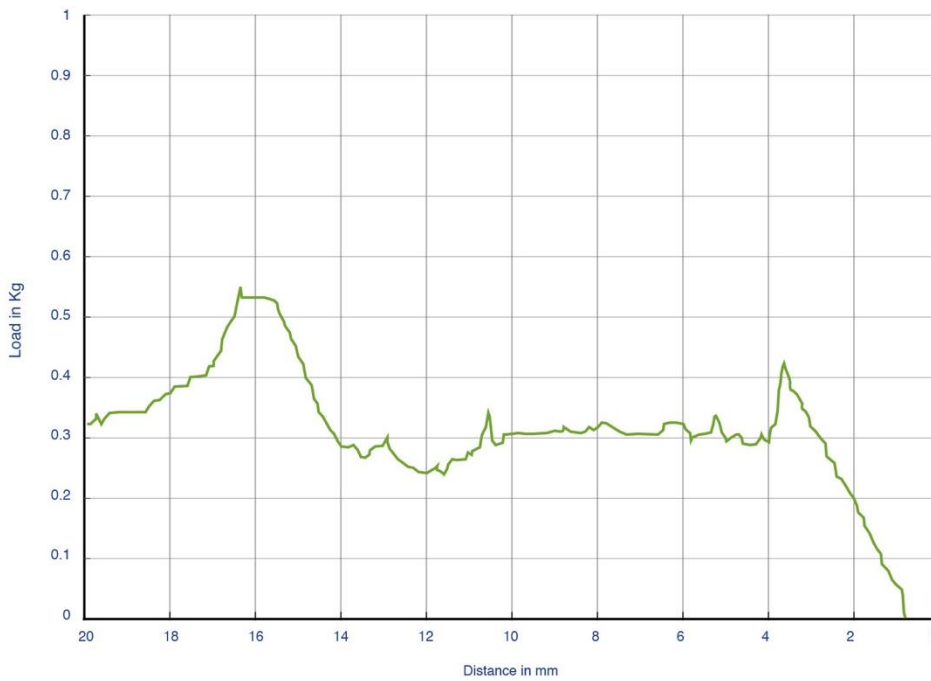
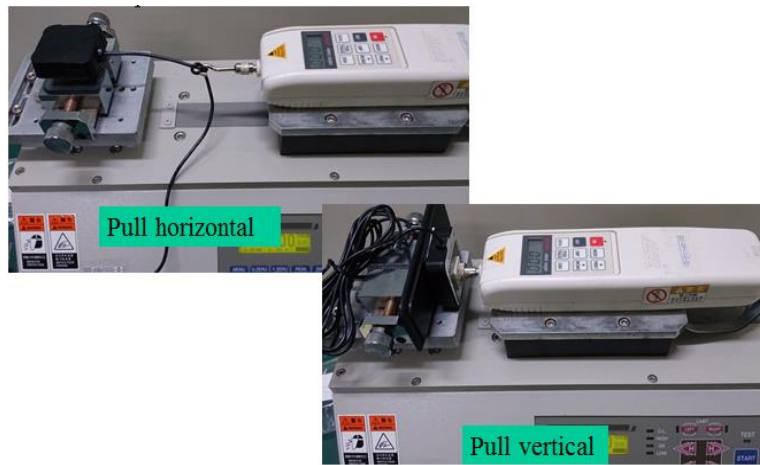

Distance (mm)	0.5	1.0	2.0	3.0	4.0	5.0	6.0	7.0	8.0	9.0
Pulling Force (Kgf)	0	0	0.18	0.31	0.3	0.3	0.3	0.3	0.3	0.3
Distance(mm)	10.0	11.0	12.0	13.0	14.0	15.0	16.0	16.3	17.0	18.0
Pulling Force (Kgf)	0.3	0.27	0.24	0.29	0.3	0.44	0.52	0.54	0.42	0.37

Horizontal Pulling Force: 0.52kgf

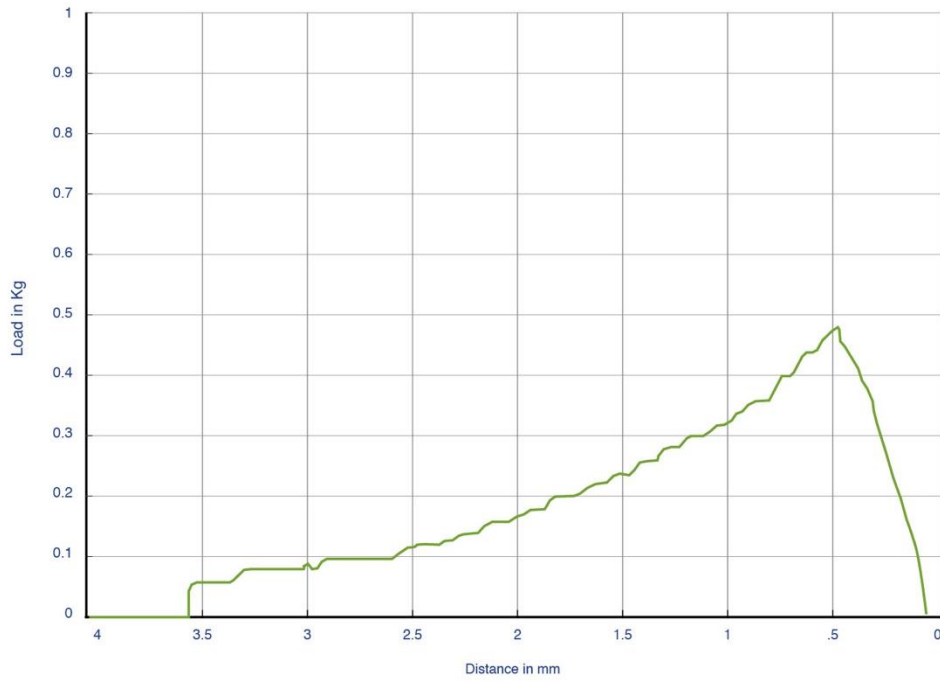

Distance(mm)	0.52	1.0	1.5	2.0	2.5	3.0	3.5	4.0
Pulling Force (Kgf)	0.48	0.33	0.24	0.17	0.12	0.08	0.06	0

Vertical Pulling Force: 0.48kgf

Changelog for the datasheet

SPE-17-8-082 - AA.180.501111

Revision: D (Current Version)

Date:	2020-06-02
Changes:	Field Test Results Added
Changes Made by:	Victor Pinazo

Previous Revisions

Revision: C

Date:	2020-04-08
Changes:	Updated RTK Data & Graphs
Changes Made by:	Jack Conroy

Revision: B

Date:	2020-01-16
Changes:	Updated Template & GNSS Data
Changes Made by:	Yu Kai Yeung

Revision: A (Original First Release)

Date:	2017-10-11
Notes:	Initial Datasheet Release
Author:	Jack Conroy



TAOGLAS®

www.taoglas.com

