

Specification

- Part No. : **A.41.A.301111**
- Description : Hercules GEN II - Straight Screw mount
GPS-GLONASS-GALILEO-BeiDou
3M SMA(M) RG-174
- Features : 2 Stage High Gain LNA (28dB)
GPS/GLONASS/GALILEO/BeiDou fully supported
IP67 & IP69K compliant housing with PC material
Heavy duty permanent mount
3M RG174 with SMA(M) connector
Height 29mm Diameter 49mm
Cable and connectors are customizable
- RoHS Compliant**



1. Introduction

The A.41 Hercules, a high gain GPS-GLONASS-GALILEO-BeiDou antenna with IP67, UV resistant and robust housing, is the latest generation of Hercules GNSS antennas, capable of receiving signals from the next generation receivers for all the main operating global satellite navigation systems in operation today, helping delivering much improved location accuracy and quicker re-acquisition time over older systems and antennas.

Focusing on the heavy duty automotive, industrial and agricultural markets, A.41 provides a dust-tight, waterproof antenna by a one-piece CNC machined nickel-steel base plate and threads, enabling A.41 to be the ideal antenna in the urban canyons of cities in factory and field environment. It is often used such on city bus, agricultural and industrial vehicles and heavy equipment.

This high gain GPS-GLONASS-GALILEO-BeiDou antenna, utilizing a 2 stage LNA, uses a unique front end SAW filter topology which reduces the possibility of LNA compression and burn-out from other nearby radio transmitters. This front end SAW filter will smooth your device certification by reducing possibility of radiated spurious emission test failures.

Its durable UV resistant PC housing is resistant to vandalism and direct attack. At only 29mm high it complies with the latest EU directives for height restrictions, whilst also enabling covert operation with a diameter of 49mm.

Cable lengths, types, and connectors are fully customizable. Contact your regional Taoglas sales office for support.

2. Specification

ELECTRICAL GPS/GLONASS/GALILEO/BeiDou	
Ceramic Antenna Specification	
Frequency (MHz)	1561.098± 2.046 MHz 1575.42 ± 1.023 MHz 1602± 5 MHz
Impedance (Ohm)	50Ω
Antenna Passive Gain	1561MHz: -4dBi @zenith 1575.42MHZ: -2.5dBi Typ. @zenith 1602MHZ: -0.5dBi Typ. @zenith
VSWR	2.0 max
LNA Circuits Specification	
Out Band Rejection	1584 ± 50MHz 13dB Min 1584 ±100MHz 20dB Min
Input Voltage(V)	Min:1.8V Typ:3.0V Max:5.5V
LNA Total Gain	28dB typical at 3.0V
Current consumption(mA)	10mA typical at 3.0V
Noise figure	2.8dB typical
MECHANICAL	
Dimensions	Φ49mm, Height 29mm
Cable type	RG174
Cable length	3 meters
Casing	PC
Connector	SMA Male
Weight	157g
Recommended Torque	24.5N·m
Max. Torque	29.4N·m
ENVIRONMENTAL	
Temperature Range	-40°C to 85°C
Waterproof	IP-67 & IP69K
Thermal Shock	100 cycles -40°C to +80°C
Shock (drop test)	1m drop on concrete 6 axes
Humidity	Non-condensing 65°C 95% RH

3. Antenna Characteristics

3.1. Return Loss

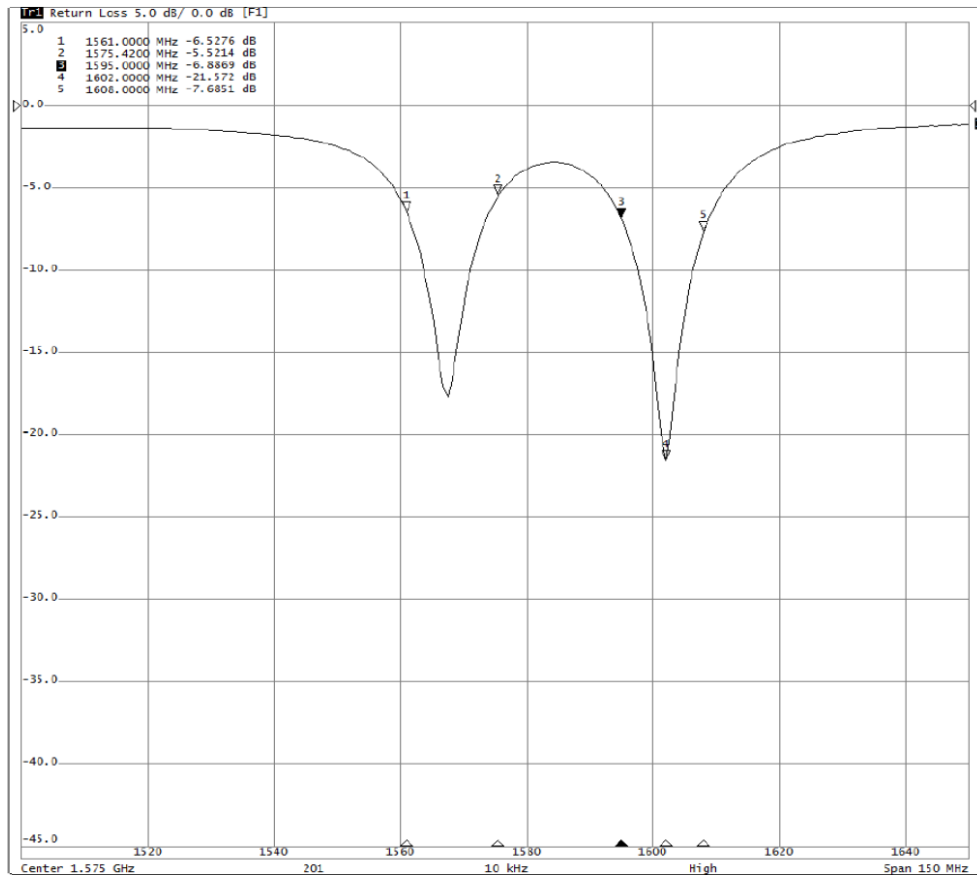

1561MHz: -6.52dB

1575.42MHz: -5.52dB

1602.6MHz: -21.57dB



3.2. Smith Chart – Impedance

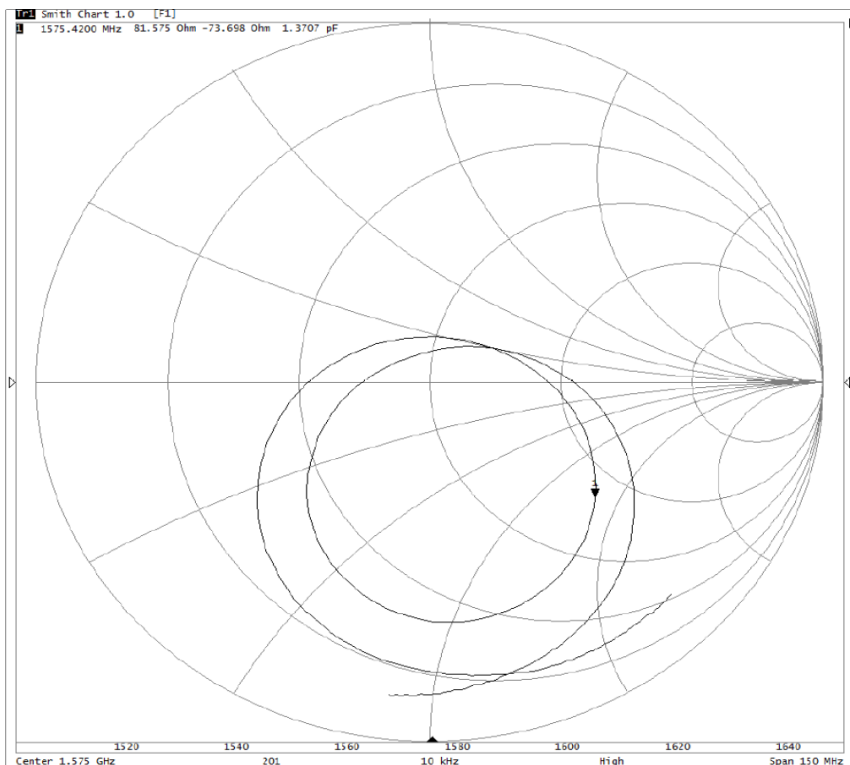

Impedance: 81.57-j0.73 Ohm

3.3. VSWR

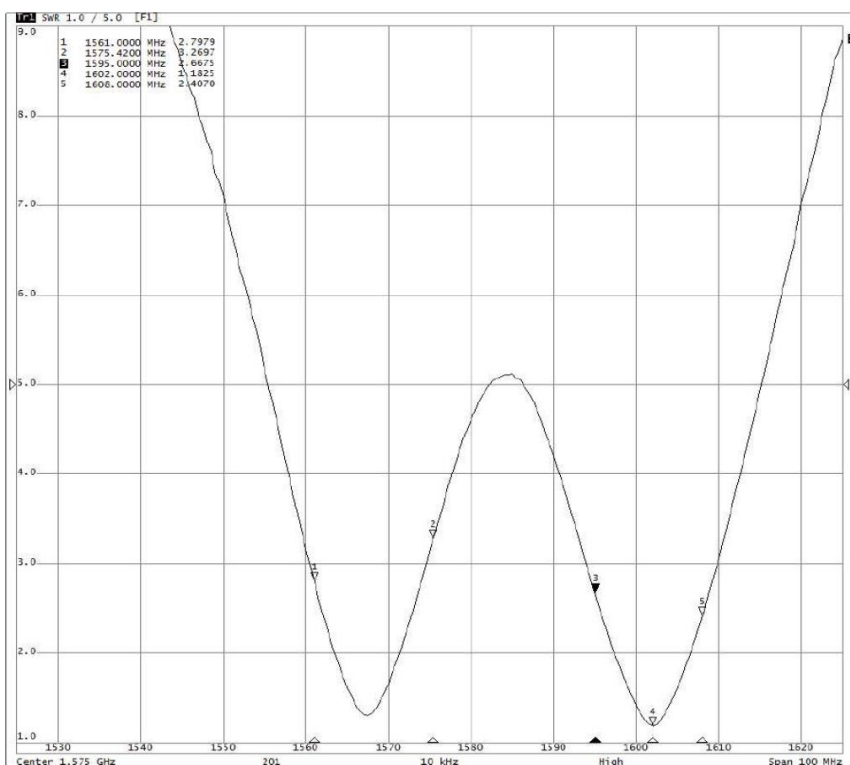

2.79@1561MHz
3.26@1575.42MHz
1.18@1602MHz

4. Antenna Radiation Pattern

XZ-Plane

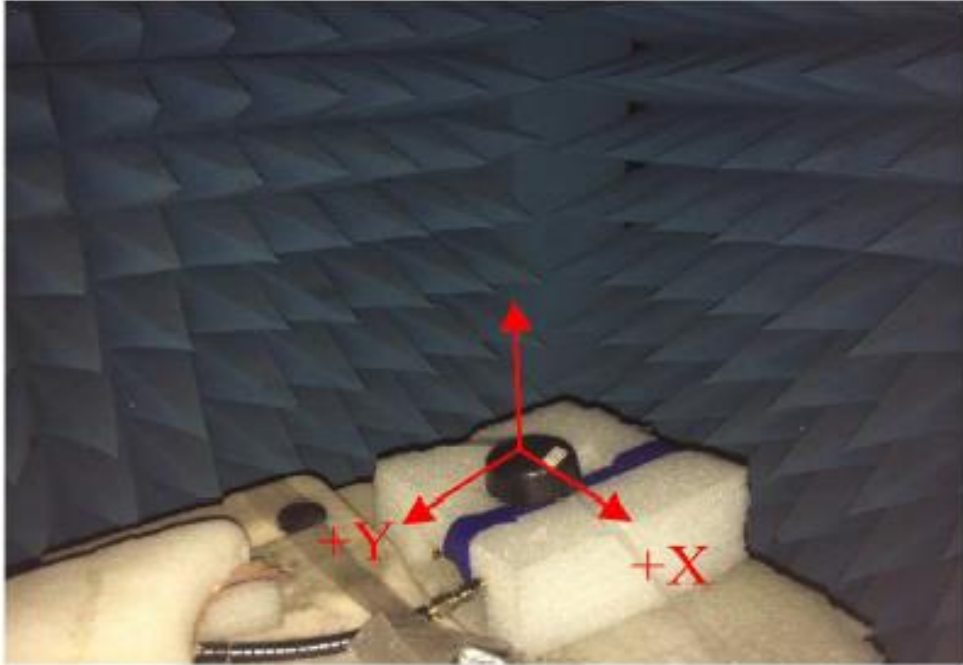

YZ-Plane

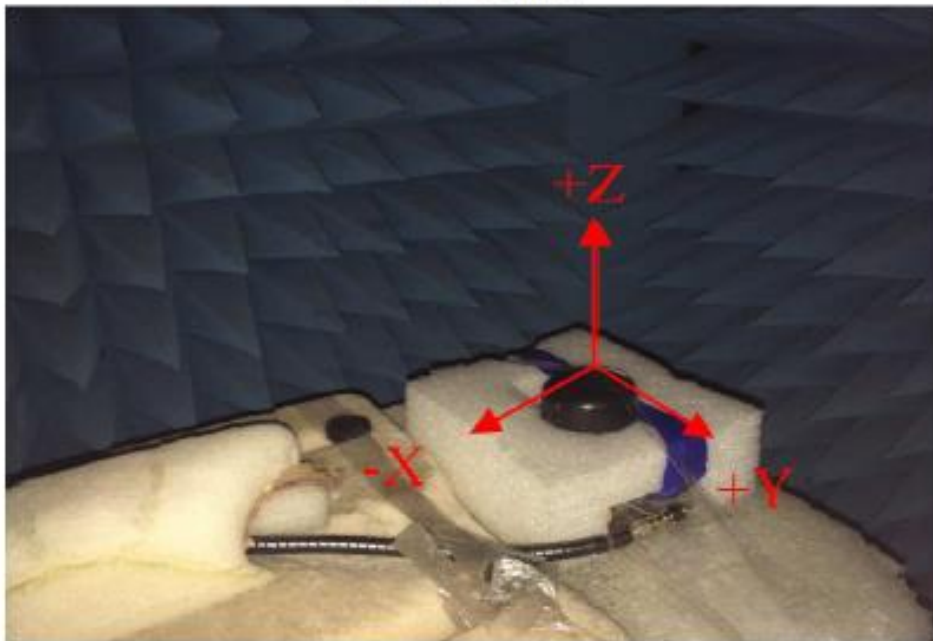

4.1. 1561MHz

XZ-Plane

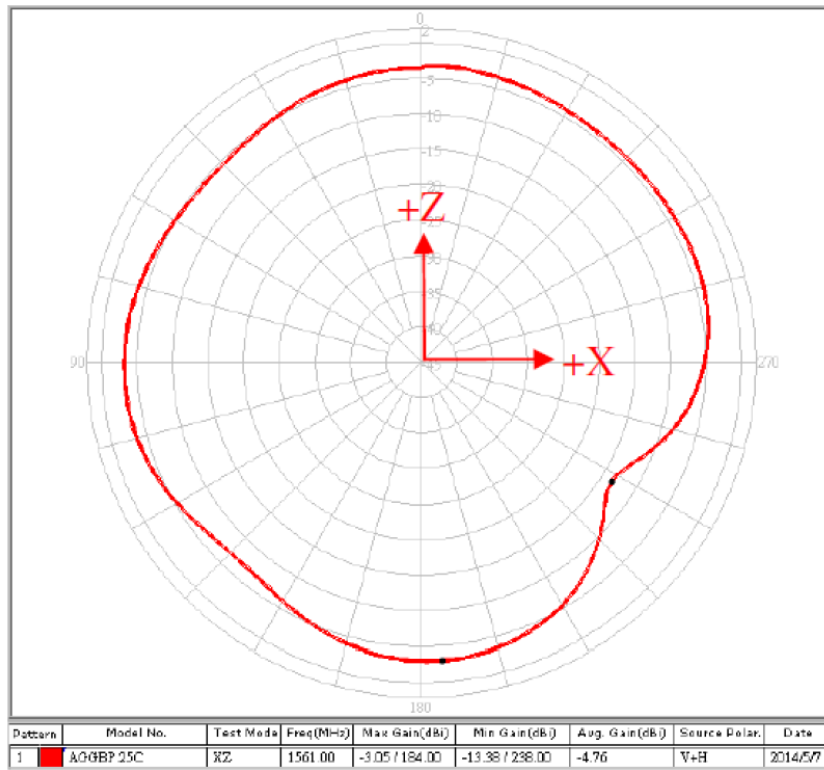

YZ-Plane

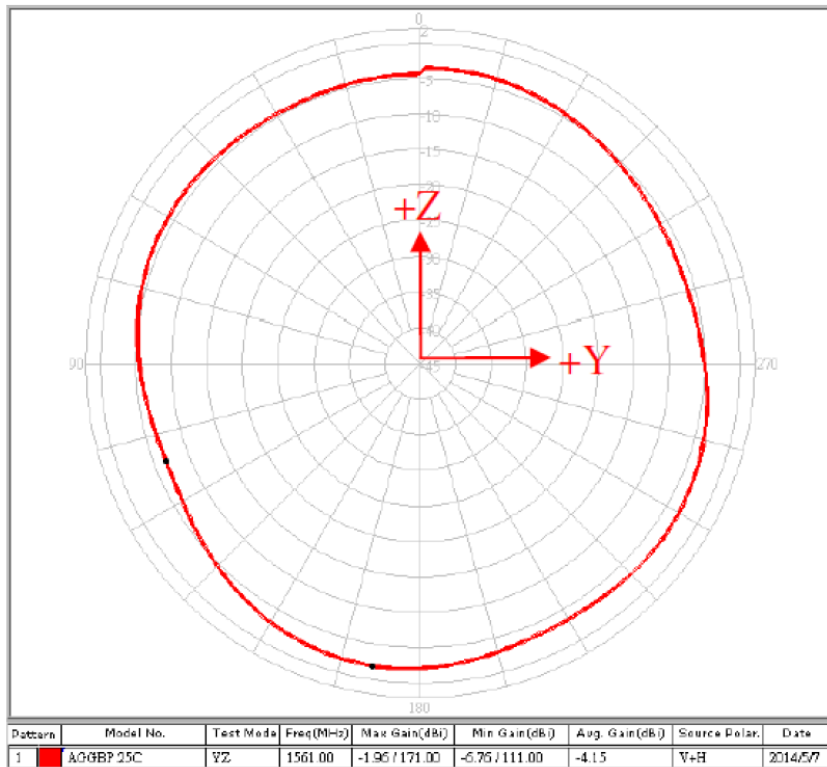

Gain Pattern Value

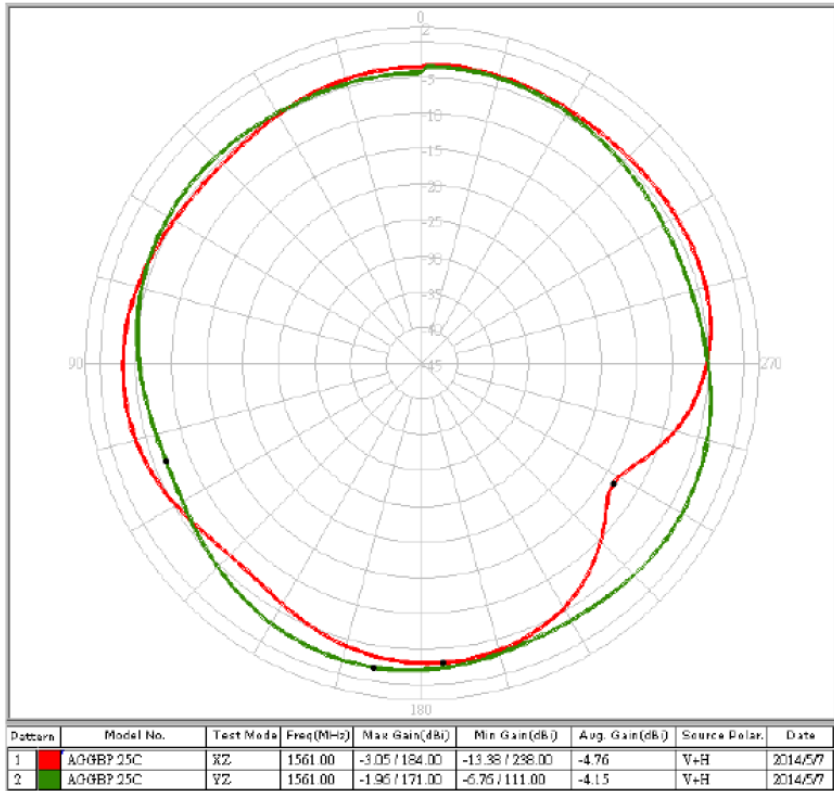

Axial Ratio Pattern (Spin Dipole Method)

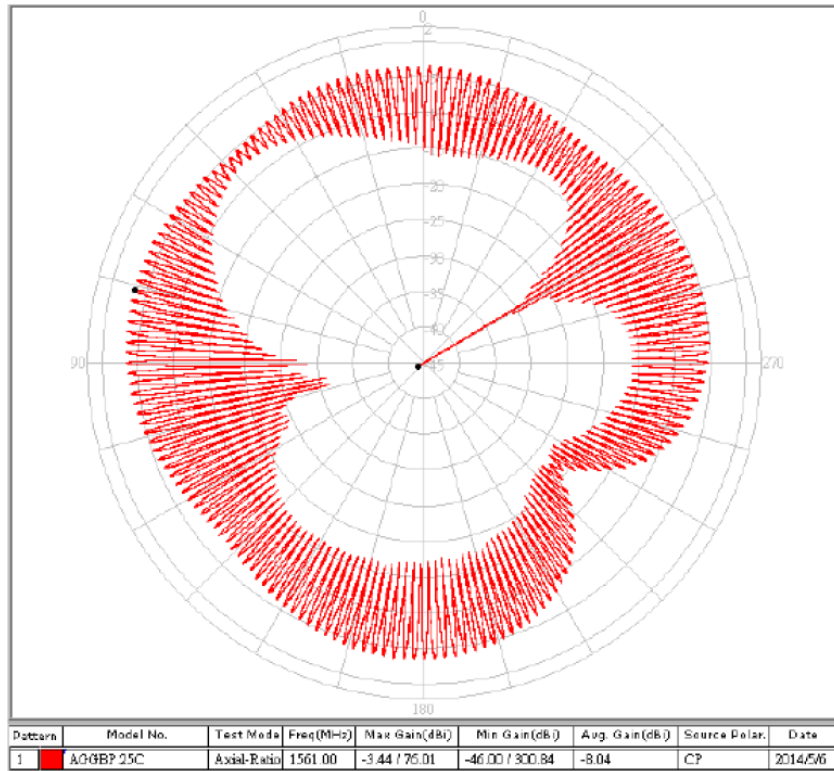



4.2. 1575.42MHz

XZ-Plane

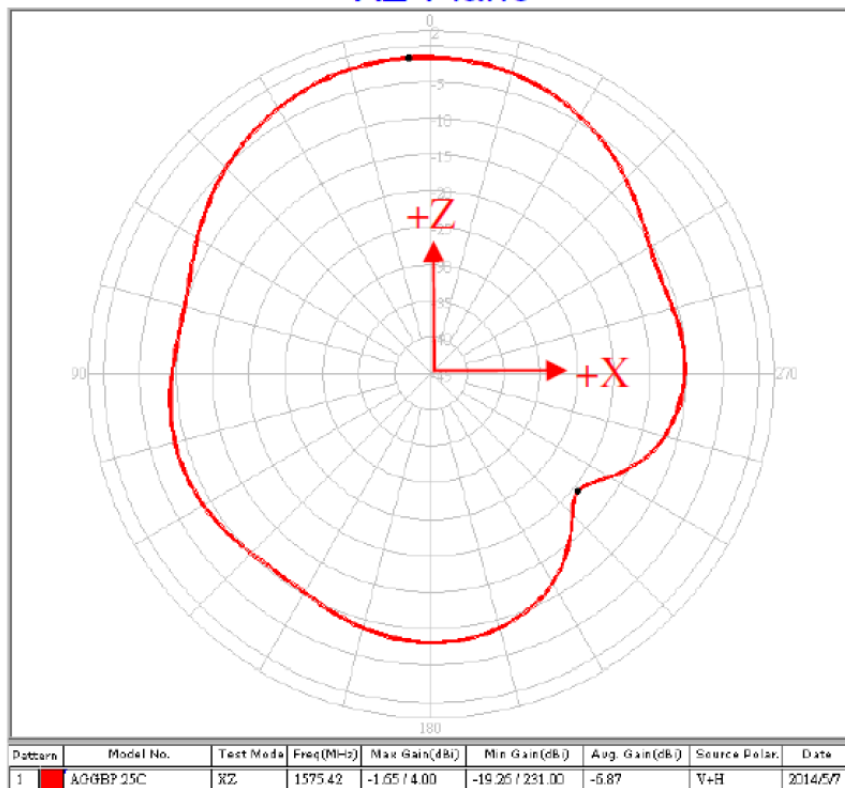

YZ-Plane

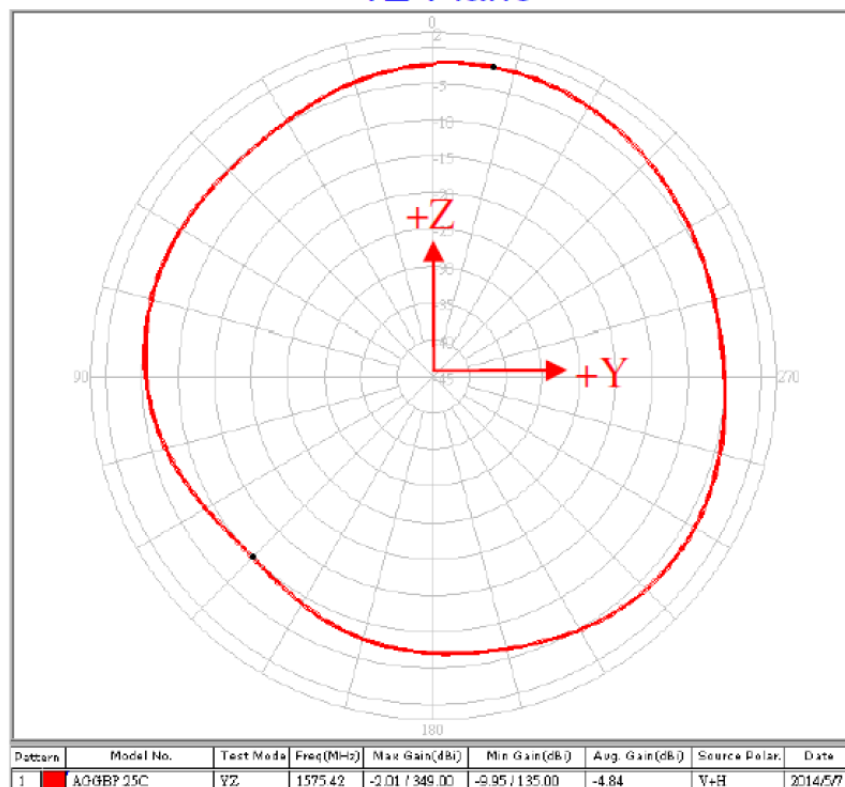



Gain Pattern Value

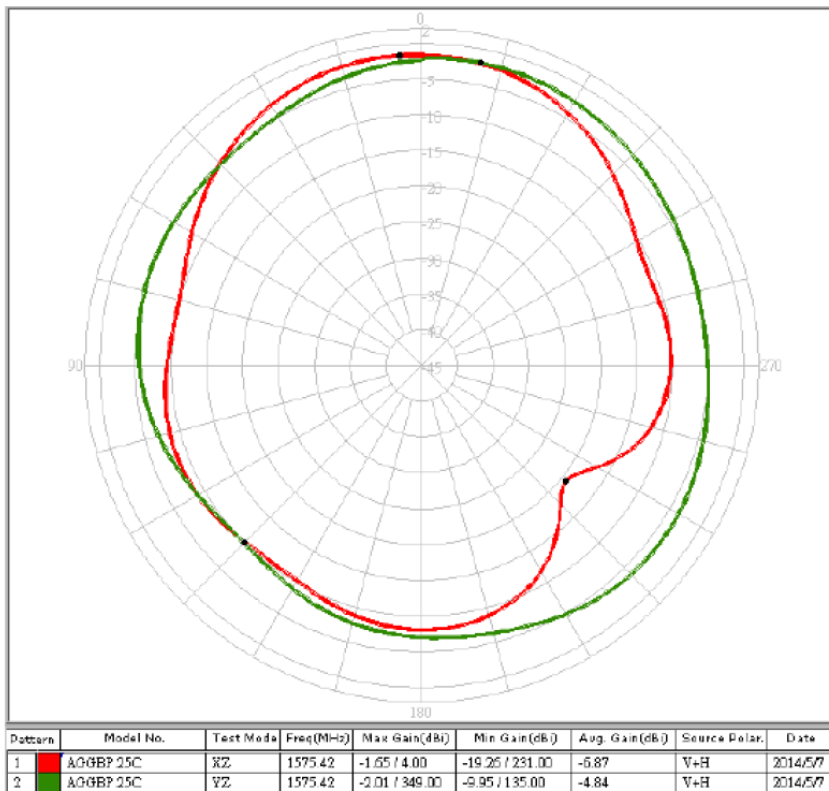

Axial Ratio Pattern (Spin Dipole Method)

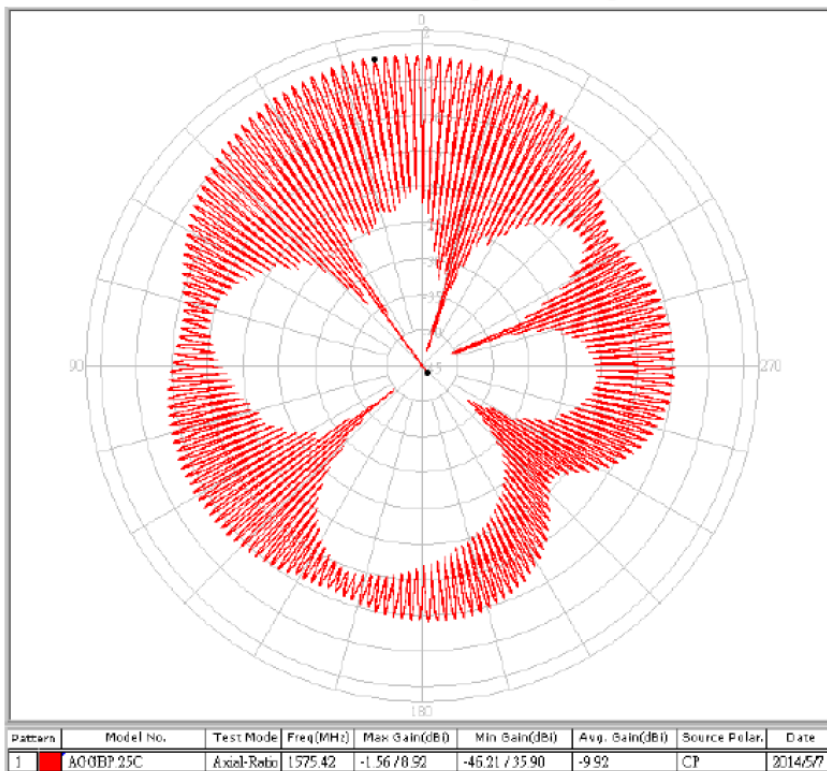

4.3 1602.6MHz

XZ-Plane

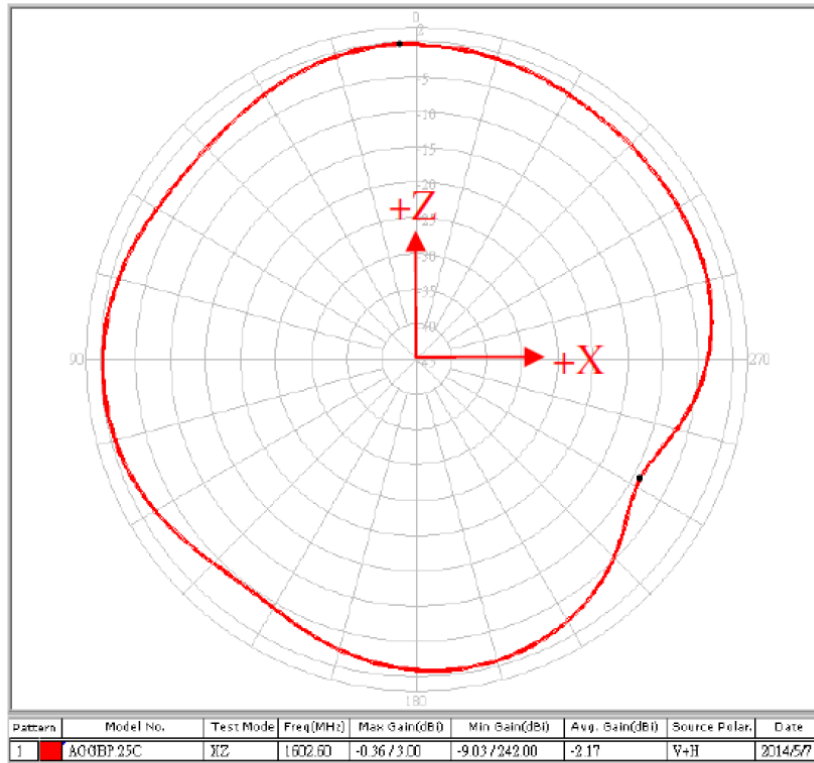

YZ-Plane

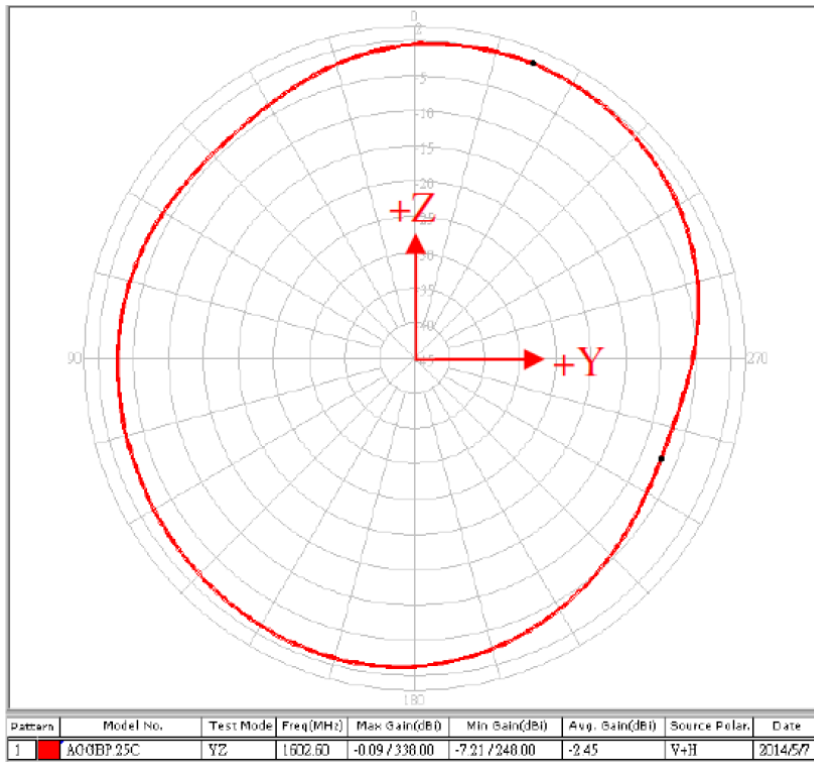

Gain Pattern Value

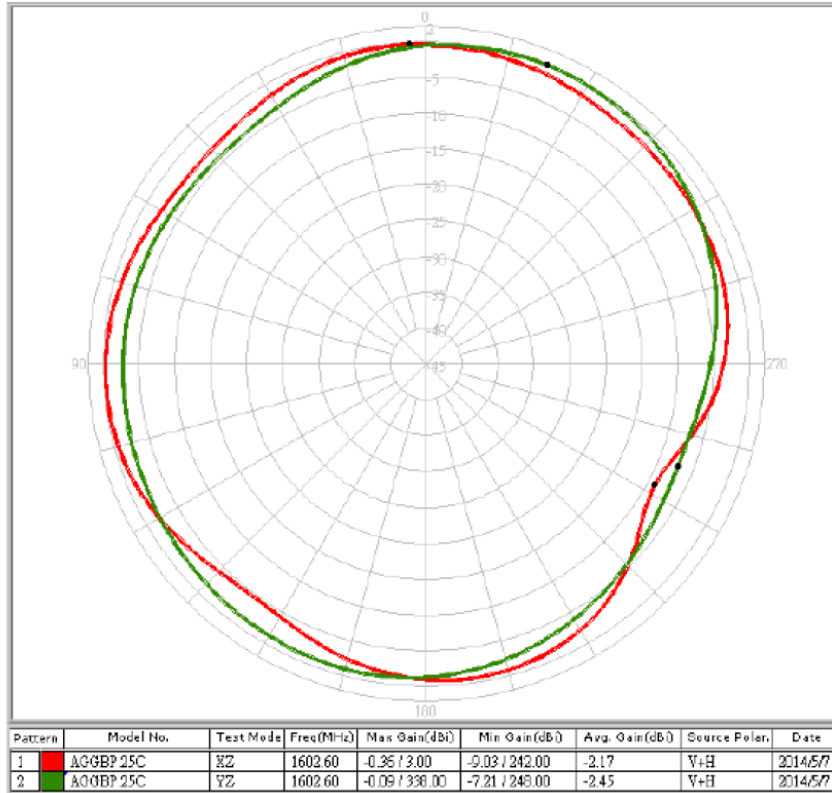

Axial Ratio Pattern (Spin Dipole Method)

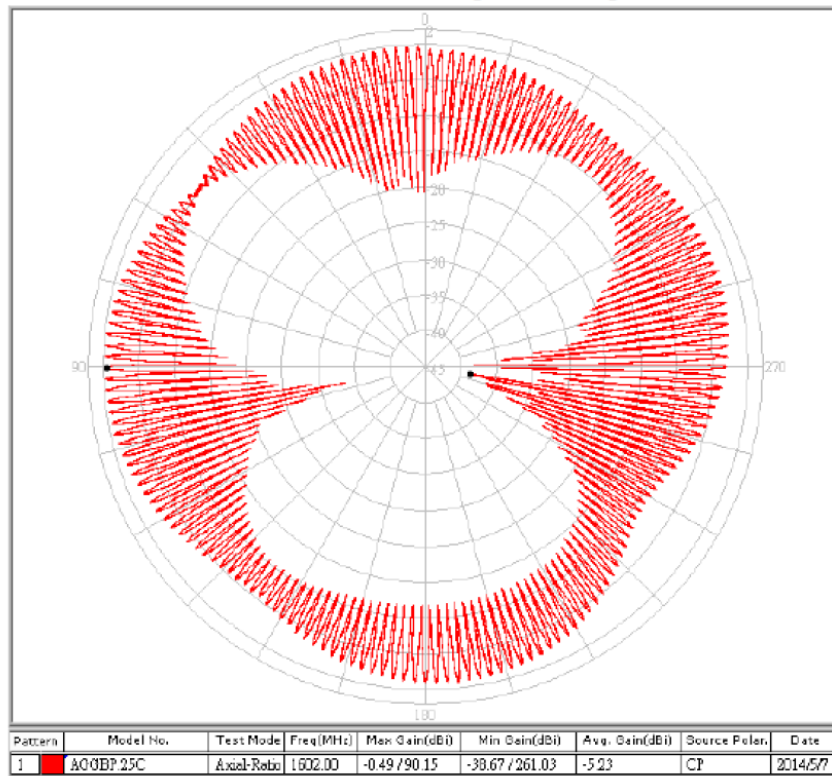

5. Installation

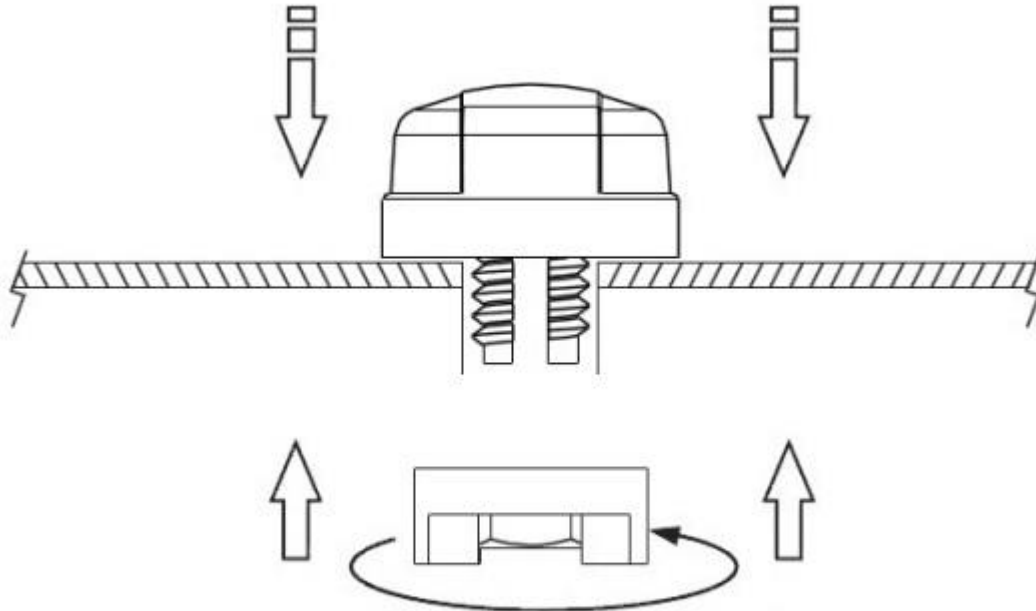

Recommended torque for Mounting is 24.5N·m
Maximum torque for mounting is 29.4N·m



6. Drawing

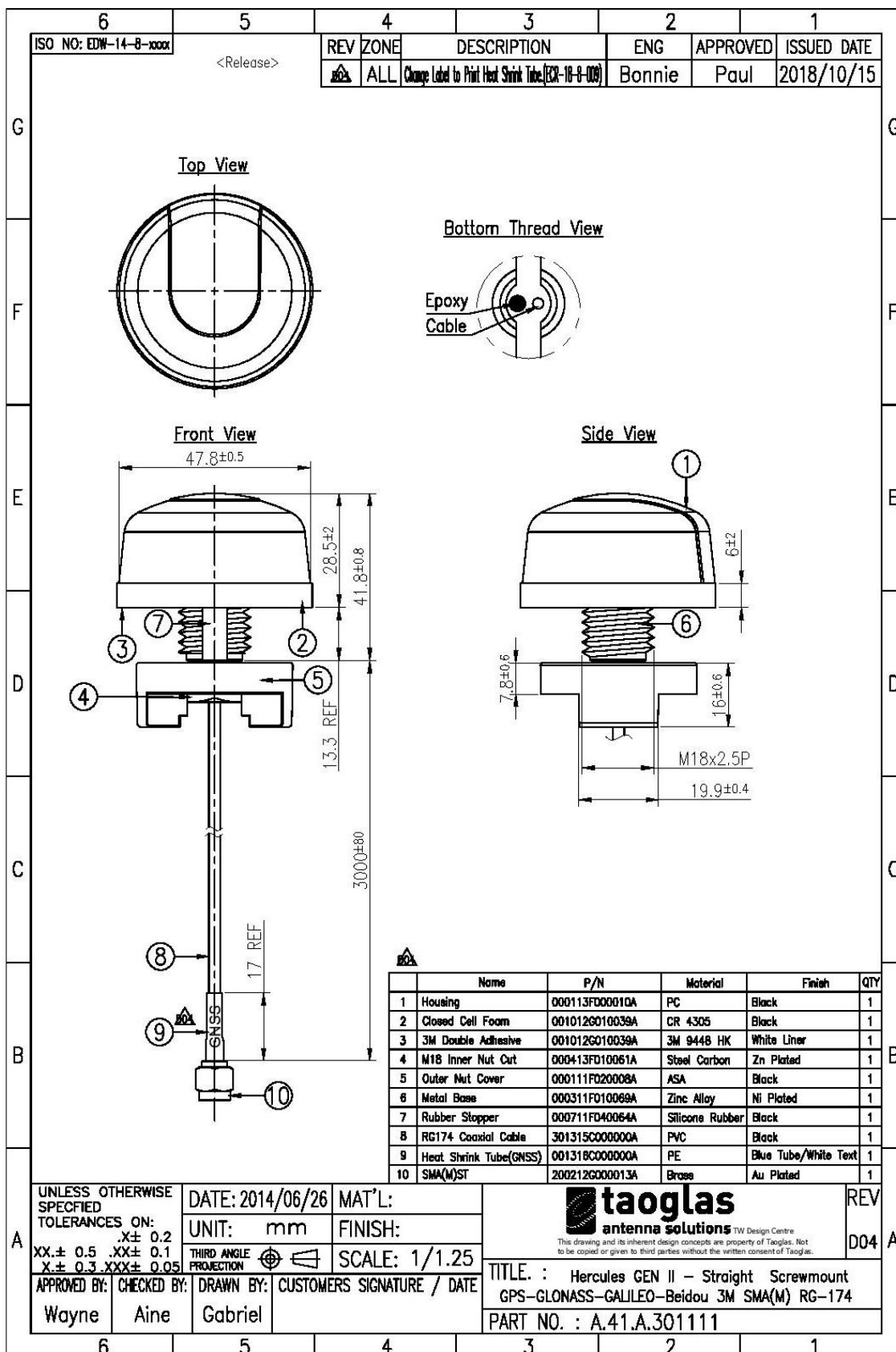

7. Packaging

1 piece A.41 per PE Bag
157g

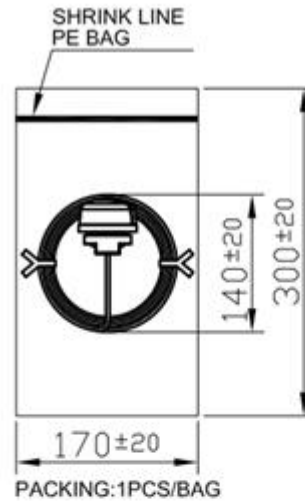
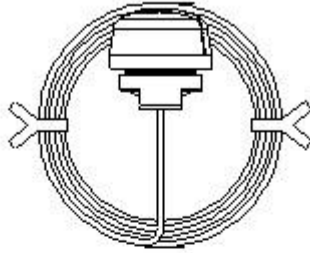

50 pieces per Carton
Weight 8.1kg

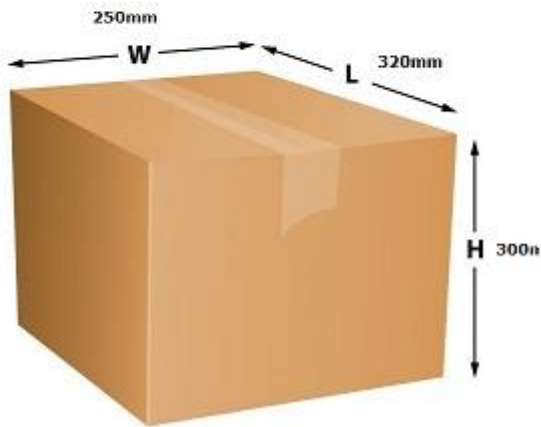

60 Cartons per pallet
Pallet Dims: 110*110*15cm
3000 pcs per pallet

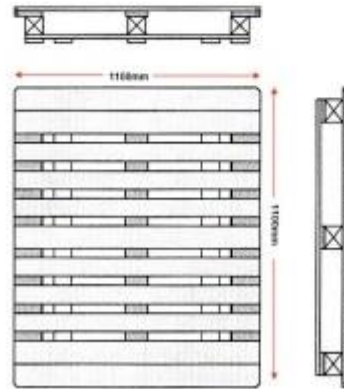

Taoglas makes no warranties based on the accuracy or completeness of the contents of this document and reserves the right to make changes to specifications and product descriptions at any time without notice. Taoglas reserves all rights to this document and the information contained herein.

Reproduction, use or disclosure to third parties without express permission is strictly prohibited.

Copyright © Taoglas Ltd.