



### TO-92S



#### Pin Definition:

1. V<sub>CC</sub>
2. GND
3. Output

### SOT-23



#### Pin Definition:

1. V<sub>CC</sub>
2. Output
3. GND

## Description

TSH188 Hall-effect sensor is a temperature stable, stress-resistant sensor. Superior high-temperature performance is made possible through a dynamic offset cancellation that utilizes chopper-stabilization. This method reduces the offset voltage normally caused by device over molding, temperature dependencies, and thermal stress. TSH188 includes the following on a single silicon chip: voltage regulator, Hall voltage generator, small-signal amplifier, chopper stabilization, Schmitt trigger. Advanced DMOS wafer fabrication processing is used to take advantage of low-voltage requirements, component matching, very low input-offset errors, and small component geometries. This device requires the presence of both south and north polarity magnetic fields for operation. In the presence of a south polarity field of sufficient strength, the device output sensor on, and only switches off when a north polarity field of sufficient strength is present

## Features

- 100% tested at 125°C
- Temperature compensation function
- Chopper stabilized amplifier stage.
- Optimized for BLDC motor applications.
- Reliable and low shifting on high Temp condition.

## Ordering Information

Part No.	Package	Packing
TSH188CT B0G	TO-92S	1Kpcs / Bulk Bag
TSH188CT A3G	TO-92S	2Kpcs / Ammo
TSH188CX RFG	SOT-23	3Kpcs / 7" Reel

**Note:** "G" denote for Halogen Free Product

## Application

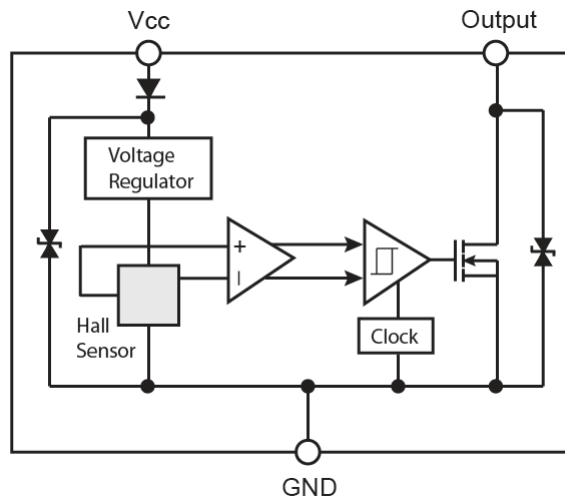
- High temperature Fan motor
- 3 phase BLDC motor application
- Speed sensing, Position sensing, Current sensing
- Revolution counting
- Solid-State Switch
- Linear/Angular Position Detection

## Absolute Maximum Rating (T<sub>a</sub> = 25°C unless otherwise noted)

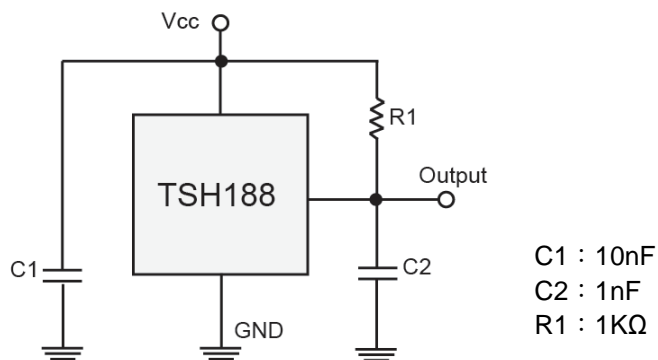
Characteristics	Limit	Value	Unit	
Supply voltage	V <sub>CC</sub>	28	V	
Output Voltage	V <sub>OUT</sub>	28	V	
Reverse voltage	V <sub>CC/OUT</sub>	-28	V	
Magnetic flux density		Unlimited	Gauss	
Output current	I <sub>OUT</sub>	50	mA	
Operating Temperature Range	T <sub>OPR</sub>	-40 to +125	°C	
Storage temperature range	T <sub>STG</sub>	-55 to +150	°C	
Maximum Junction Temp	T <sub>J</sub>	150	°C	
Thermal Resistance - Junction to Ambient	TO-92S	θ <sub>JA</sub>	206	°C/W
	SOT-23			
Thermal Resistance - Junction to Case	TO-92S	θ <sub>JC</sub>	148	°C/W
	SOT-23			
Package Power Dissipation	TO-92S	P <sub>D</sub>	606	mW
	SOT-23			

**Note:** Do not apply reverse voltage to V<sub>CC</sub> and V<sub>OUT</sub> Pin, It may be caused for Miss function or damaged device.

### Block Diagram



### Typical Application Circuit



### Electrical Specifications (DC Operating Parameters : $T_A=+25^{\circ}\text{C}$ , $V_{CC}=12\text{V}$ )

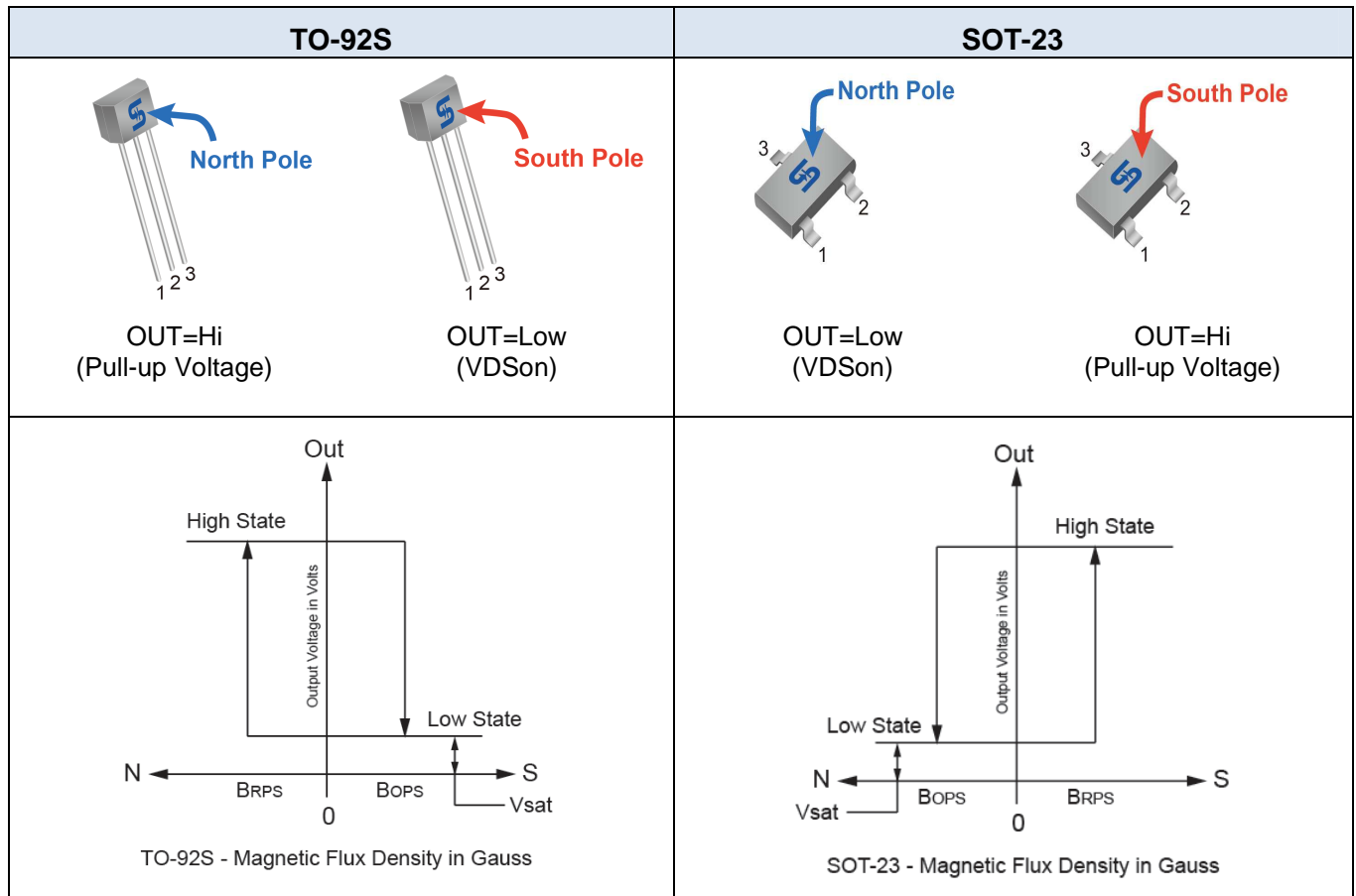
Parameters	Test Conditions	Min	Typ	Max	Units
Supply Voltage	Operating	2.5	--	24	V
Supply Current	$B < B_{OP}$	--	--	5	mA
Output Saturation Voltage	$I_{OUT}=20\text{mA}, B > B_{OP}$	--	--	400	mV
Output Leakage Current	$I_{OFF} B < B_{RP}, V_{OUT} = 12\text{V}$	--	--	10	uA
Internal Oscillator Chopper Frequency		--	69	--	kHz
Output Rise Time	$R_L=1.1\text{K}\Omega, C_L=20\text{pF}$	--	0.04	0.45	uS
Output Fall Time	$R_L=820\Omega; C_L=20\text{pF}$	--	0.18	0.45	uS
ESD	HBM	4	--	--	KV
Operate Point		5(-25)	--	25(-5)	Gauss
Release Point		-25(5)	--	-5(25)	Gauss
Hysteresis		--	30	--	Gauss

**Note:** 1G (Gauss) = 0.1mT (millitesta)

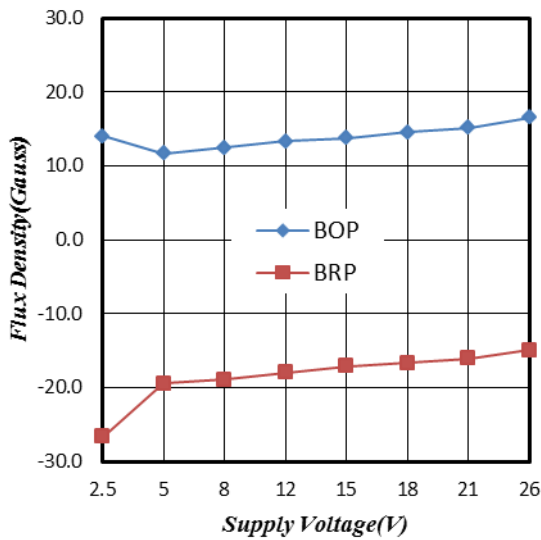
**Output Behavior versus Magnetic Pole**

DC Operating Parameters:  $T_A = -40$  to  $125^\circ\text{C}$ ,  $V_{CC} = 2.5\text{--}24\text{V}$

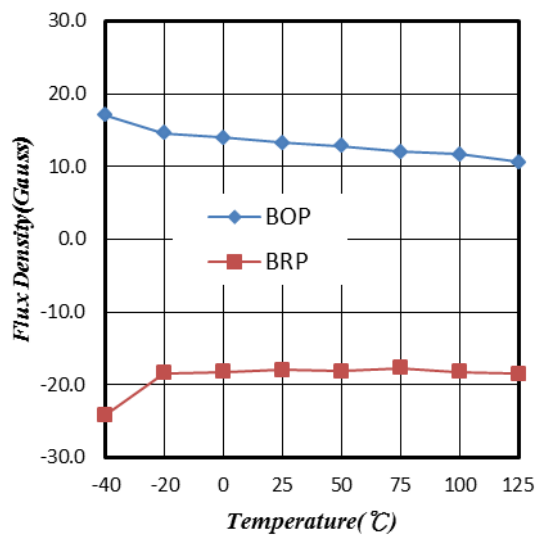
Parameter	Test condition	OUT (TO-92S)	OUT (SOT-23)
North pole	$B > B_{OP}$	Open(Hi)	Low
South pole	$B < B_{RP}$	Low	Open(Hi)



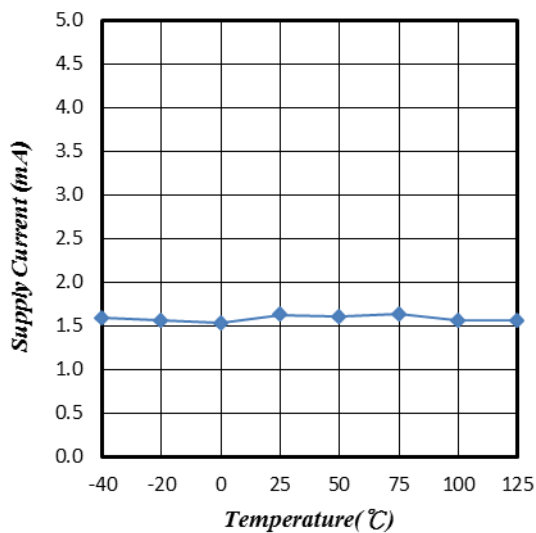
**Characteristic Performance**



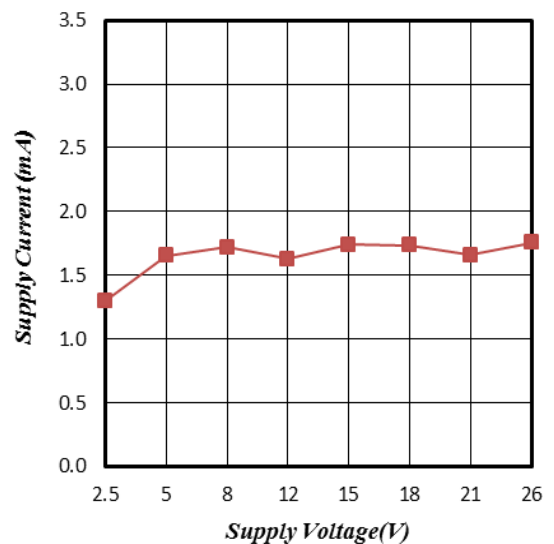
**Figure 1. Supply Voltage vs. Flux Density**



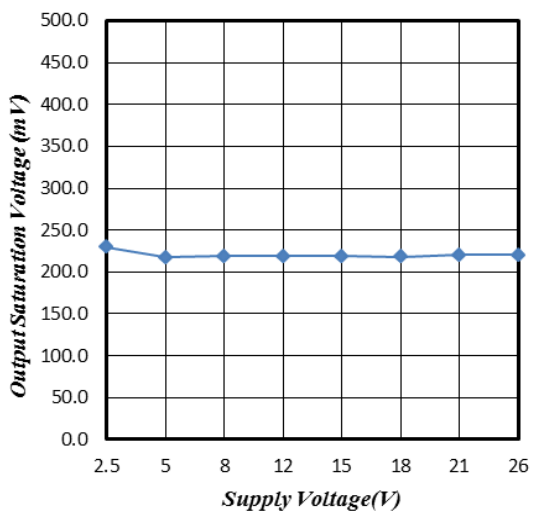
**Figure 2. Temperature vs. Flux Density**



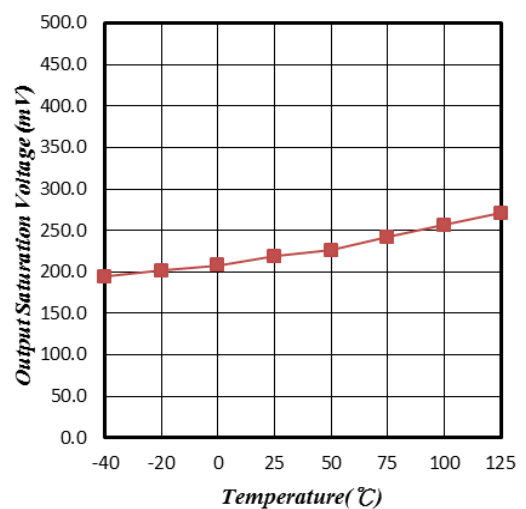
**Figure 3. Supply Current vs. Temperature**



**Figure 4. Supply Current vs. Supply Voltage**

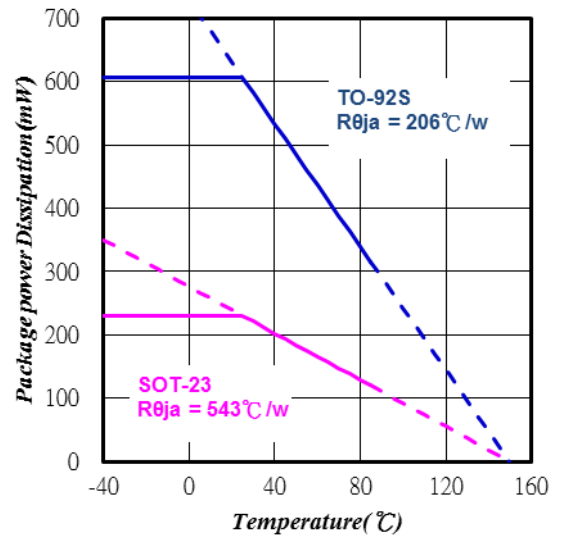
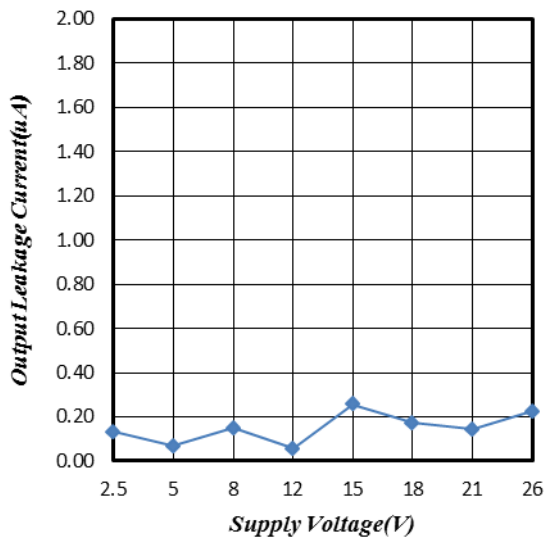


**Figure 5. Supply Voltage vs. Saturation Voltage**



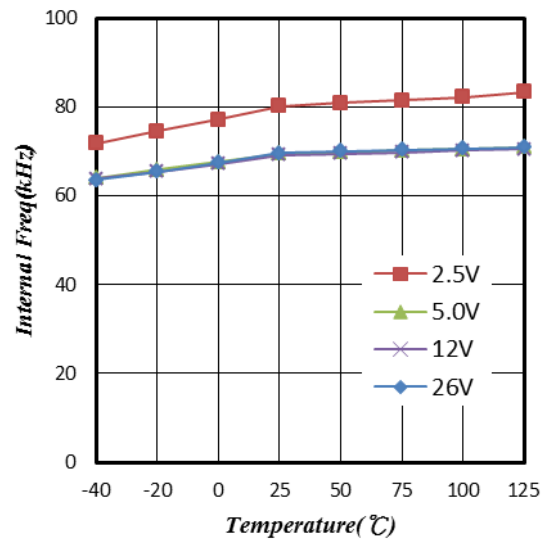
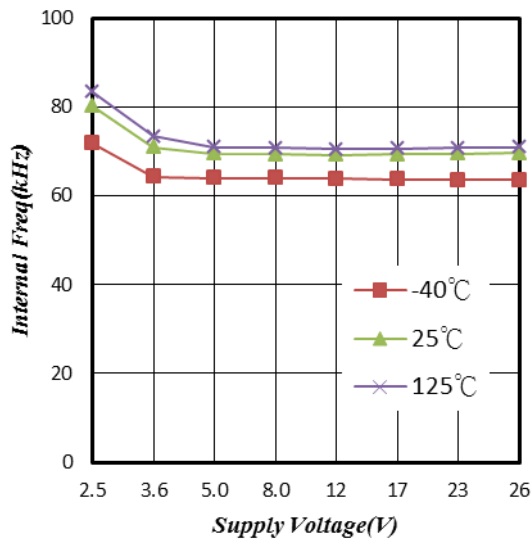
**Figure 6. Saturation Voltage vs. Temperature**

**Characteristic Performance**



**Figure 7. Supply Voltage vs. Leakage Current**

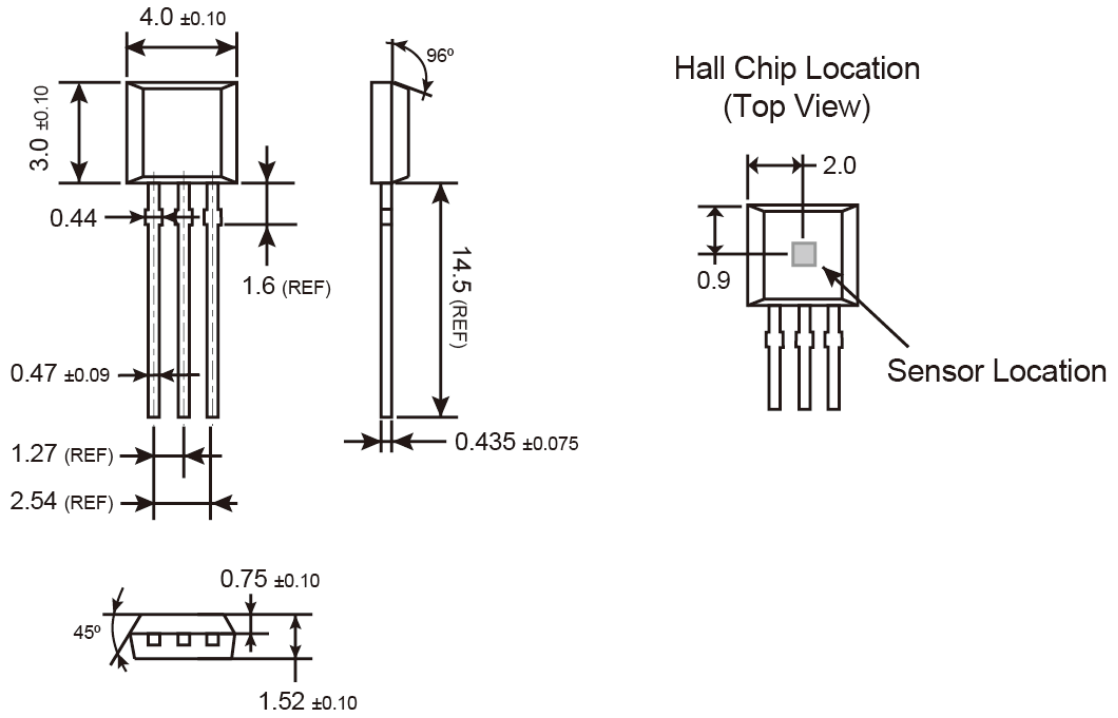
**Figure 8. Temperature vs. Power Dissipation**



**Figure 9. Supply Voltage vs. Internal Frequency**

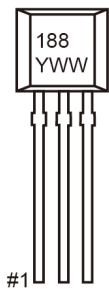
**Figure 10. Temperature vs. Internal Frequency**

**TO-92S Mechanical Drawing**



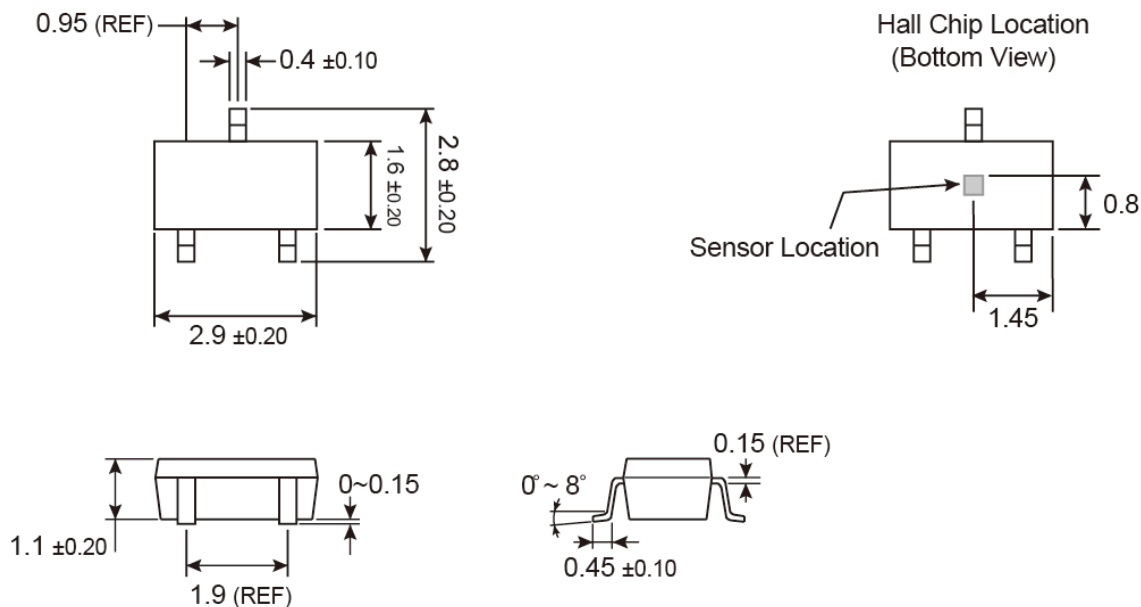
Unit: Millimeters

**Marking Diagram**



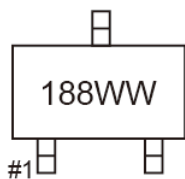
**188** = Device Code  
**Y** = Year Code  
**WW** = Week Code (01~52)

**SOT-23 Mechanical Drawing**



Unit: Millimeters

**Marking Diagram**



**188** = Device Code  
**WW** = Week Code Table

week	1	2	3	4	5	6	7	8	9	10	11	12	13
code	OA	OB	OC	OD	OE	OF	OG	OH	OI	OJ	OK	OL	OM
week	14	15	16	17	18	19	20	21	22	23	24	25	26
code	ON	OO	OP	OQ	OR	OS	OT	OU	OV	OW	OX	OY	OZ
week	27	28	29	30	31	32	33	34	35	36	37	38	39
code	PA	PB	PC	PD	PE	PF	PG	PH	PI	PJ	PK	PL	PM
week	40	41	42	43	44	45	46	47	48	49	50	51	52
code	PN	PO	PP	PQ	PR	PS	PT	PU	PV	PW	PX	PY	PZ

## Notice

Specifications of the products displayed herein are subject to change without notice. TSC or anyone on its behalf, assumes no responsibility or liability for any errors or inaccuracies.

Information contained herein is intended to provide a product description only. No license, express or implied, to any intellectual property rights is granted by this document. Except as provided in TSC's terms and conditions of sale for such products, TSC assumes no liability whatsoever, and disclaims any express or implied warranty, relating to sale and/or use of TSC products including liability or warranties relating to fitness for a particular purpose, merchantability, or infringement of any patent, copyright, or other intellectual property right.

The products shown herein are not designed for use in medical, life-saving, or life-sustaining applications. Customers using or selling these products for use in such applications do so at their own risk and agree to fully indemnify TSC for any damages resulting from such improper use or sale.