

## Glass Passivated Bridge Rectifiers

### FEATURES

- Ideal for printed circuit board
- High case dielectric strength
- High surge current capability
- UL Recognized File # E-326243
- Compliant to RoHS Directive 2011/65/EU and in accordance to WEEE 2002/96/EC
- Halogen-free according to IEC 61249-2-21 definition



D3K



### MECHANICAL DATA

**Case:** D3K

Molding compound, UL flammability classification rating 94V-0

Base P/N with suffix "G" on packing code - halogen-free

**Terminal:** Matte tin plated leads, solderable per JESD22-B102

Meet JESD 201 class 1A whisker test

**Weight:** 1.24 g (approximately)

**Mounting Torque:** 0.8 N.M max.

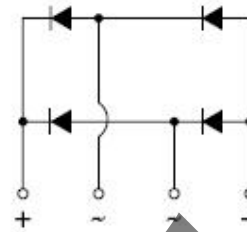

MAXIMUM RATINGS AND ELECTRICAL CHARACTERISTICS (T <sub>A</sub> =25°C unless otherwise noted)					
PARAMETER	SYMBOL	UR4KB 60	UR4KB 80	UR4KB 100	UNIT
Maximum repetitive peak reverse voltage	V <sub>RRM</sub>	600	800	1000	V
Maximum RMS voltage	V <sub>RMS</sub>	420	560	700	V
Maximum DC blocking voltage	V <sub>DC</sub>	600	800	1000	V
Maximum average forward current Without heat sink T <sub>C</sub> =120°C 60Hz sine wave resistance load With heat sink T <sub>C</sub> =138°C	I <sub>F(AV)</sub>		2 4		A
Peak forward surge current, 8.3 ms single half sine-wave superimposed on rated load	I <sub>FSM</sub>		135		A
Rating of fusing ( t < 8.3ms)	I <sup>2</sup> t		75		A <sup>2</sup> s
Maximum instantaneous forward voltage (Note 1) I <sub>F</sub> = 2 A	V <sub>F</sub>		1.0		V
Maximum DC reverse current at rated DC blocking voltage	I <sub>R</sub>		10		μA
Typical thermal resistance	R <sub>θJC</sub> R <sub>θJL</sub> R <sub>θJA</sub>		8.2 9.3 14		°C/W
Operating junction temperature range	T <sub>J</sub>		- 55 to +150		°C
Storage temperature range	T <sub>STG</sub>		- 55 to +150		°C

Note 1: Pulse Test with PW=300μs, 1% Duty Cycle

ORDERING INFORMATION				
PART NO.	PACKING CODE	GREEN COMPOUND CODE	PACKAGE	PACKING
UR4KBx0 (Note 1)	C2	Suffix "G"	D3K	1,500 / BOX

Note 1: "x" defines voltage from 600V (UR4KB60) to 1000V (UR4KB100)

EXAMPLE				
PREFERRED P/N	PART NO.	PACKING CODE	GREEN COMPOUND CODE	DESCRIPTION
UR4KB60 C2	UR4KB60	C2		
UR4KB60 C2G	UR4KB60	C2	G	Green compound

**RATINGS AND CHARACTERISTICS CURVES**

(TA=25°C unless otherwise noted)

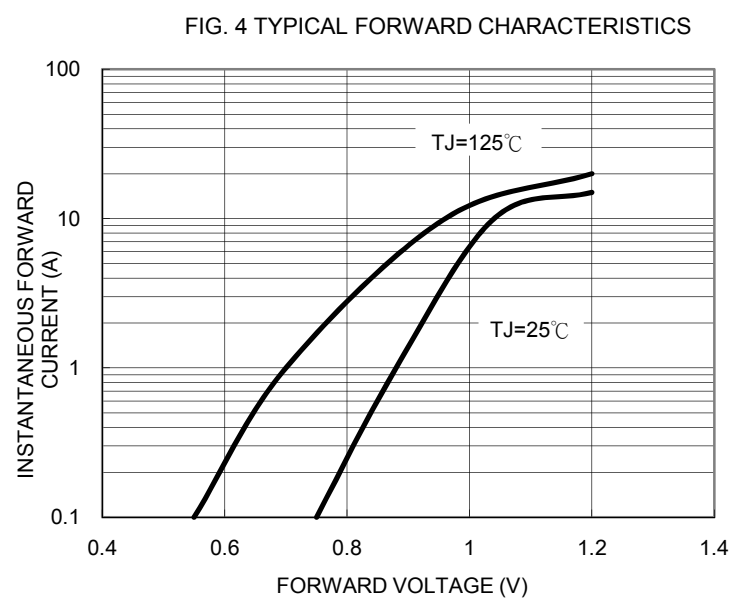
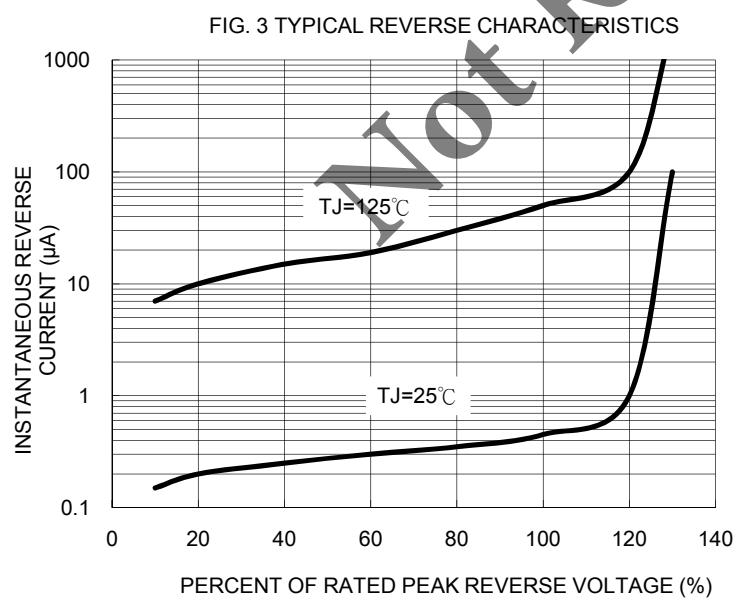
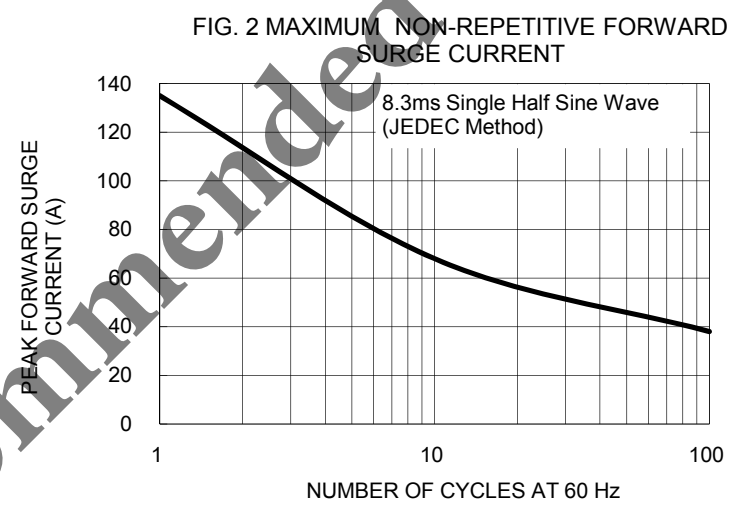
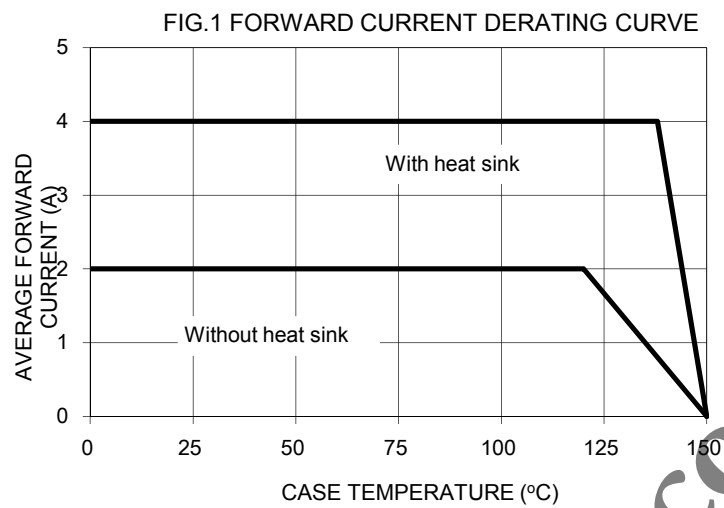
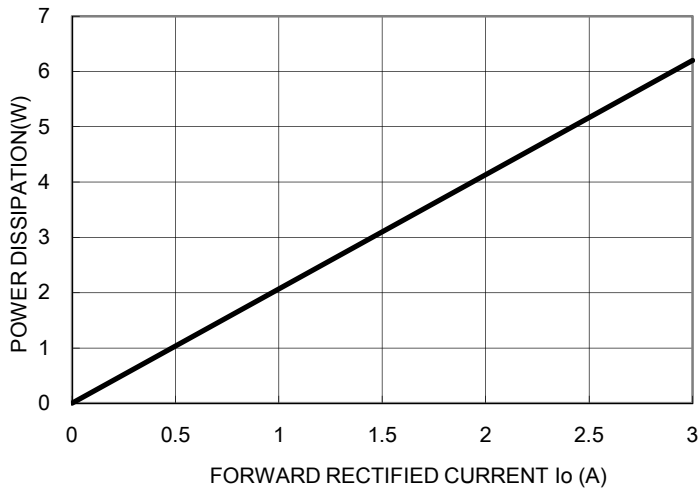
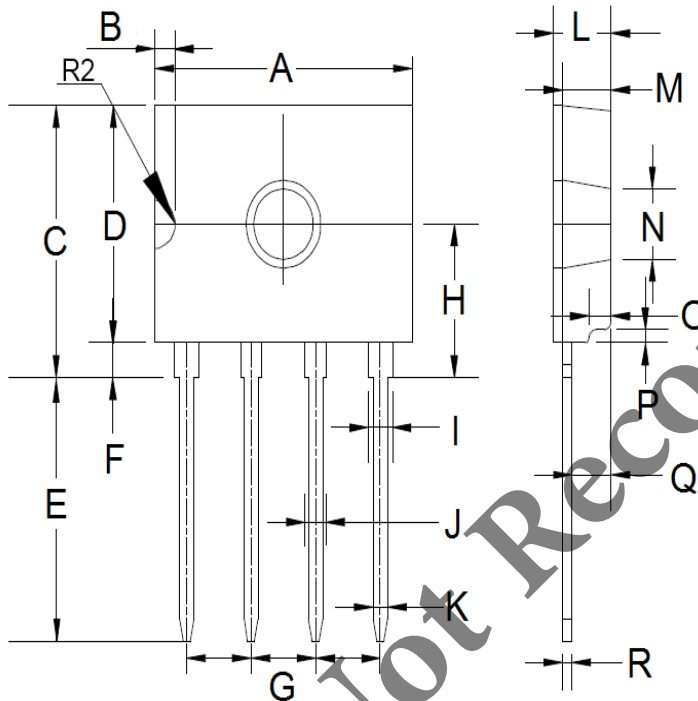

FIG. 5 FORWARD POWER DISSIPATION



PACKAGE OUTLINE DIMENSIONS



DIM.	Unit (mm)		Unit (inch)	
	Min	Max	Min	Max
A	13.50	14.10	0.531	0.555
B	0.70	1.40	0.028	0.055
C	11.70	12.30	0.461	0.484
D	10.50	11.10	0.413	0.437
E	11.70	12.30	0.461	0.484
F	1.10	1.40	0.043	0.055
G	3.51	4.11	0.138	0.162
H	6.70	7.30	0.264	0.287
I	1.10	1.50	0.043	0.059
J	1.05	1.25	0.041	0.049
K	0.66	0.86	0.026	0.034
L	2.90	3.30	0.114	0.130
M	2.40	2.80	0.094	0.110
N	3.10	3.40	0.122	0.134
O	1.00	1.40	0.039	0.055
P	0.40	0.80	0.016	0.031
Q	1.80	2.40	0.071	0.094
R	0.40	0.60	0.016	0.024

MARKING DIAGRAM

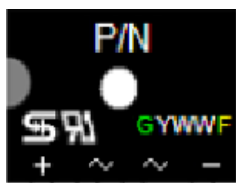

- P/N = Specific Device Code
- G = Green Compound
- YWW = Date Code
- F = Factory Code

**Not Recommended**

#### Notice

Specifications of the products displayed herein are subject to change without notice. TSC or anyone on its behalf, assumes no responsibility or liability for any errors inaccuracies.

Information contained herein is intended to provide a product description only. No license, express or implied, to any intellectual property rights is granted by this document. Except as provided in TSC's terms and conditions of sale for such products, TSC assumes no liability whatsoever, and disclaims any express or implied warranty, relating to sale and/or use of TSC products including liability or warranties relating to fitness for a particular purpose, merchantability, or infringement of any patent, copyright, or other intellectual property right.

The products shown herein are not designed for use in medical, life-saving, or life-sustaining applications. Customers using or selling these products for use in such applications do so at their own risk and agree to fully indemnify TSC for any damages resulting from such improper use or sale.