

## 20A, 100V - 200V Trench Schottky Rectifier

### FEATURES

- Patented Trench Schottky technology
- Excellent high temperature stability
- Low forward voltage
- Low power loss/ high efficiency
- High forward surge capability
- Compliant to RoHS directive 2011/65/EU and in accordance to WEEE 2002/96/EC
- Halogen-free according to IEC 61249-2-21

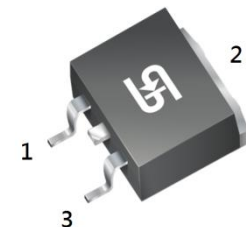
### APPLICATIONS

- Lighting application
- Switching mode power supply (SMPS)
- Adapters
- On-board DC/DC converter

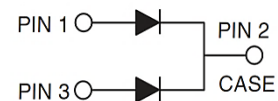
### MECHANICAL DATA

- Case: TO-263AB(D<sup>2</sup>PAK)
- Molding compound meets UL 94V-0 flammability rating
- Packing code with suffix "G" means green compound (halogen-free)
- Terminal: Matte tin plated leads, solderable per J-STD-002
- Meet JESD 201 class 1A whisker test
- Polarity: As marked
- Weight: 1.6 mg (approximately)

KEY PARAMETERS		
PARAMETER	VALUE	UNIT
$I_{F(AV)}$	2 x 10	A
$V_{RRM}$	100 - 200	V
$I_{FSM}$	150	A
$T_{JMAX}$	150	°C
Package	TO-263AB(D <sup>2</sup> PAK)	
Configuration	Dual die	



TO-263AB(D<sup>2</sup>PAK)



ABSOLUTE MAXIMUM RATINGS ( $T_A = 25^\circ\text{C}$ unless otherwise noted)						
PARAMETER	SYMBOL	TSD20H 100CW	TSD20H 120CW	TSD20H 150CW	TSD20H 200CW	UNIT
Marking code on the device		TSD20H 100CW	TSD20H 120CW	TSD20H 150CW	TSD20H 200CW	
Repetitive peak reverse voltage	$V_{RRM}$	100	120	150	200	V
Forward current	Per device	20				A
	Per diode	10				
Surge peak forward current, 8.3 ms single half sine-wave superimposed on rated load per diode	$I_{FSM}$	150				A
Critical rate of rise of off-state voltage	dV/dt	10,000				V/ $\mu\text{s}$
Junction temperature	$T_J$	-55 to +150				°C
Storage temperature	$T_{STG}$	-55 to +150				°C

<b>THERMAL PERFORMANCE</b>			
<b>PARAMETER</b>	<b>SYMBOL</b>	<b>LIMIT</b>	<b>UNIT</b>
Junction-to-lead thermal resistance	$R_{\theta JL}$	3.8	$^{\circ}\text{C/W}$
Junction-to-case thermal resistance	$R_{\theta JC}$	2.8	$^{\circ}\text{C/W}$

<b>ELECTRICAL SPECIFICATIONS</b> ( $T_A = 25^{\circ}\text{C}$ unless otherwise noted)						
<b>PARAMETER</b>		<b>CONDITIONS</b>	<b>SYMBOL</b>	<b>TYP</b>	<b>MAX</b>	<b>UNIT</b>
Forward voltage per diode <sup>(1)</sup>	TSD20H100CW	$I_F = 5\text{A}, T_J = 25^{\circ}\text{C}$	$V_F$	0.57	-	V
		$I_F = 10\text{A}, T_J = 25^{\circ}\text{C}$		0.67	0.79	V
		$I_F = 5\text{A}, T_J = 125^{\circ}\text{C}$		0.50	-	V
		$I_F = 10\text{A}, T_J = 125^{\circ}\text{C}$		0.59	0.68	V
	TSD20H120CW	$I_F = 5\text{A}, T_J = 25^{\circ}\text{C}$		0.62	-	V
		$I_F = 10\text{A}, T_J = 25^{\circ}\text{C}$		0.78	0.87	V
		$I_F = 5\text{A}, T_J = 125^{\circ}\text{C}$		0.53	-	V
		$I_F = 10\text{A}, T_J = 125^{\circ}\text{C}$		0.63	-	V
	TSD20H150CW	$I_F = 5\text{A}, T_J = 25^{\circ}\text{C}$		0.72	0.72	V
		$I_F = 10\text{A}, T_J = 25^{\circ}\text{C}$		0.81	0.90	V
		$I_F = 5\text{A}, T_J = 125^{\circ}\text{C}$		0.58	-	V
		$I_F = 10\text{A}, T_J = 125^{\circ}\text{C}$		0.66	0.75	V
	TSD20H200CW	$I_F = 5\text{A}, T_J = 25^{\circ}\text{C}$		0.77	-	V
		$I_F = 10\text{A}, T_J = 25^{\circ}\text{C}$		0.83	0.93	V
		$I_F = 5\text{A}, T_J = 125^{\circ}\text{C}$		0.62	-	V
		$I_F = 10\text{A}, T_J = 125^{\circ}\text{C}$		0.68	0.78	V
Reverse current @ rated $V_R$ per diode <sup>(2)</sup>	TSD20H100CW	$T_J = 25^{\circ}\text{C}$	$I_R$	-	200	$\mu\text{A}$
	TSD20H120CW	$T_J = 125^{\circ}\text{C}$		8	25	mA
	TSD20H150CW	$T_J = 25^{\circ}\text{C}$		-	100	$\mu\text{A}$
	TSD20H200CW	$T_J = 125^{\circ}\text{C}$		3	15	mA

**Notes:**

1. Pulse test with  $PW=0.3\text{ ms}$
2. Pulse test with  $PW=30\text{ ms}$

**ORDERING INFORMATION**

<b>PART NO.</b>	<b>PACKING CODE</b>	<b>PACKING CODE SUFFIX</b>	<b>PACKAGE</b>	<b>PACKING</b>
TSD20HxxxCW (Note 1 , 2)	C0	G	D <sup>2</sup> PAK	50 / Tube
	MN			800 / 13" Plastic reel

**Notes:**

- "xxx" defines voltage from 100V (TSD20H100CW) to 200V (TSD20H200CW)
- Whole series with green compound (halogen-free)

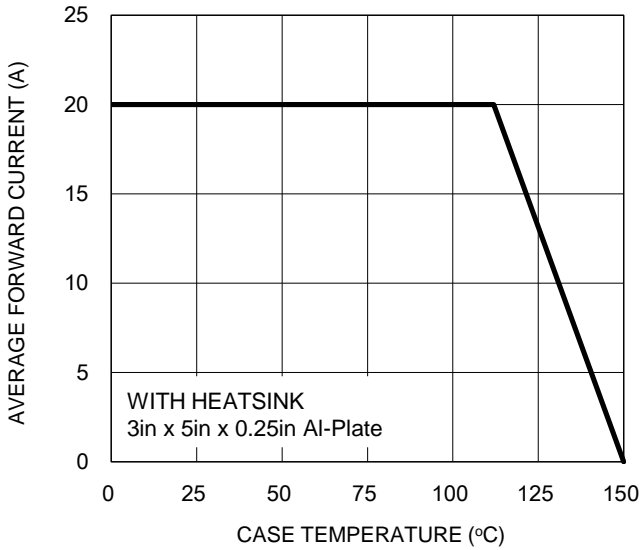
**EXAMPLE**

<b>EXAMPLE P/N</b>	<b>PART NO.</b>	<b>PACKING CODE</b>	<b>PACKING CODE SUFFIX</b>	<b>DESCRIPTION</b>
TSD20H100CW C0G	TSD20H100CW	C0	G	AEC-Q101 qualified Green compound

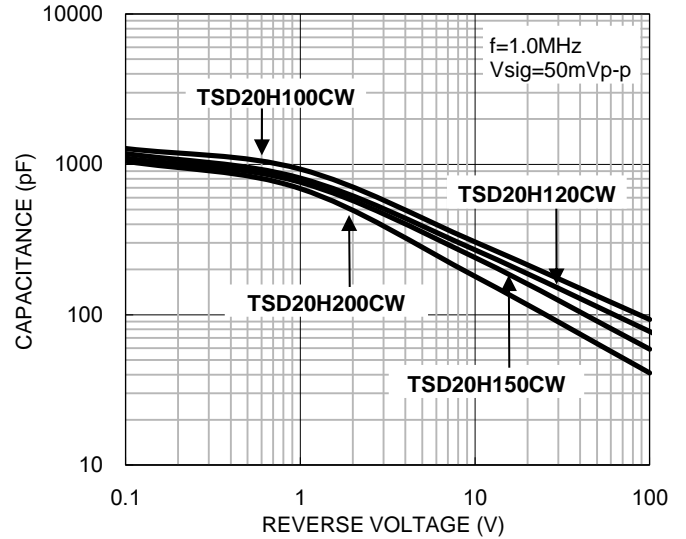
**CHARACTERISTICS CURVES**

( $T_A = 25^\circ\text{C}$  unless otherwise noted)

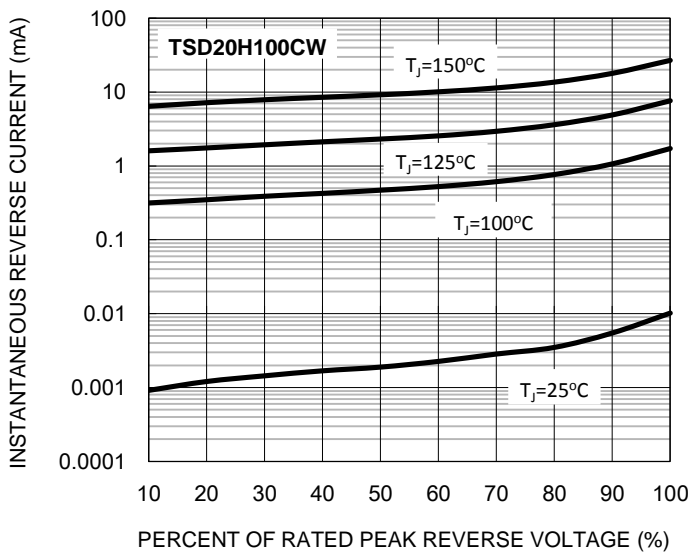
**Fig.1 Forward Current Derating Curve**



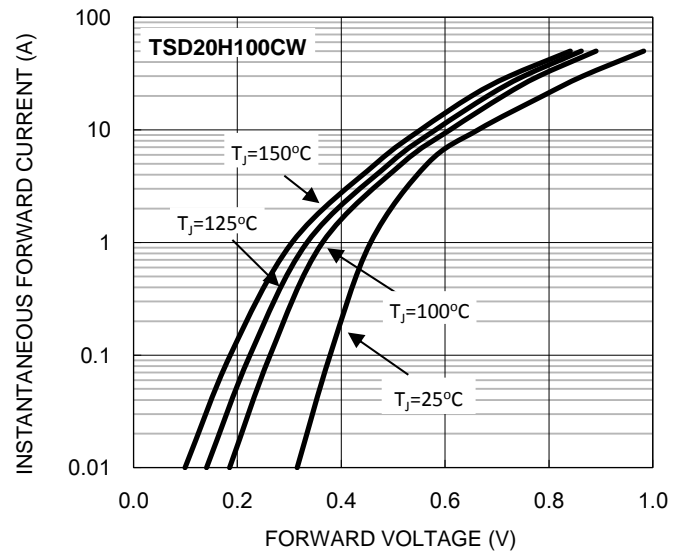
**Fig.2 Typical Junction Capacitance**



**Fig.3 Typical Reverse Characteristics**



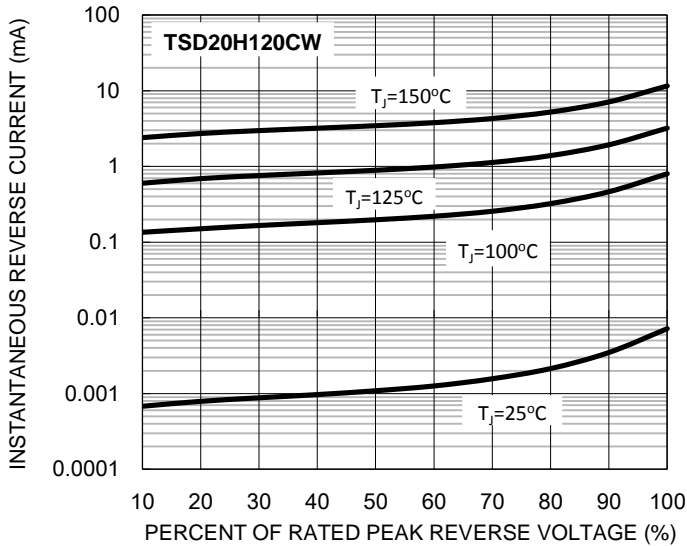
**Fig.4 Typical Forward Characteristics**



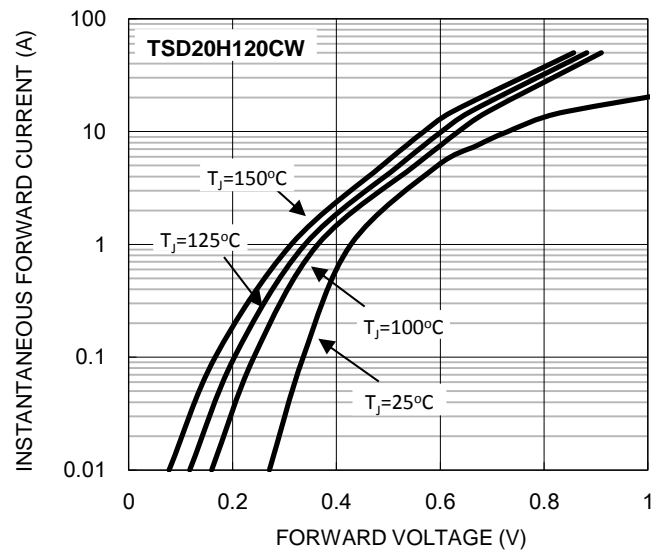
**CHARACTERISTICS CURVES**

( $T_A = 25^\circ\text{C}$  unless otherwise noted)

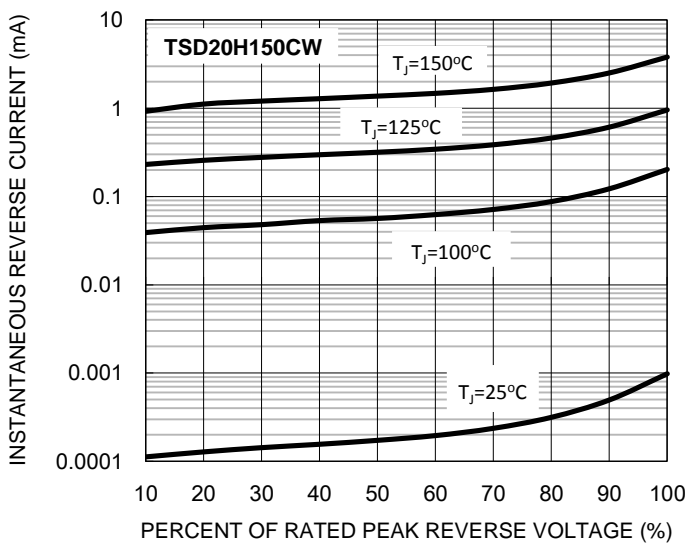
**Fig.5 Typical Reverse Characteristics**



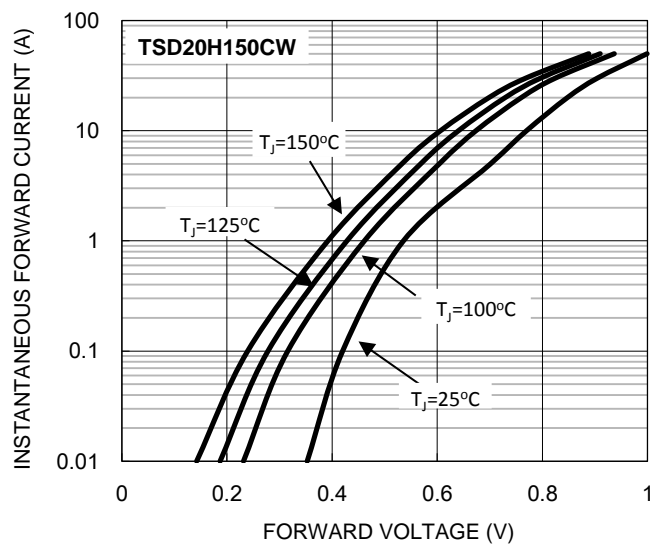
**Fig.6 Typical Forward Characteristics**



**Fig.7 Typical Reverse Characteristics**



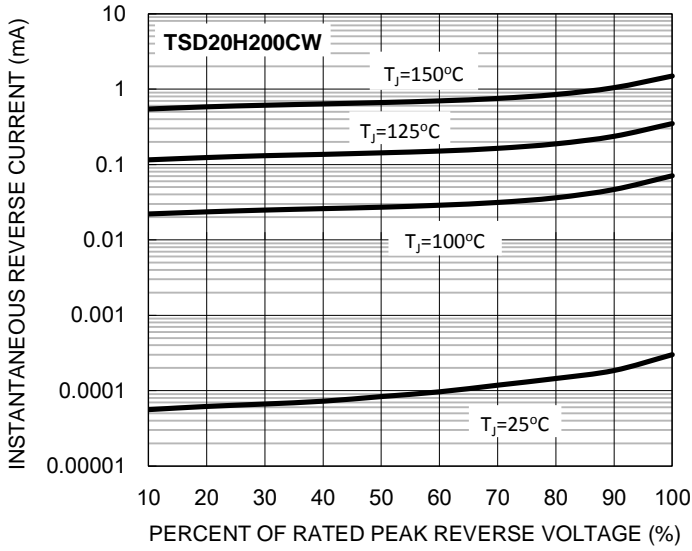
**Fig.8 Typical Forward Characteristics**



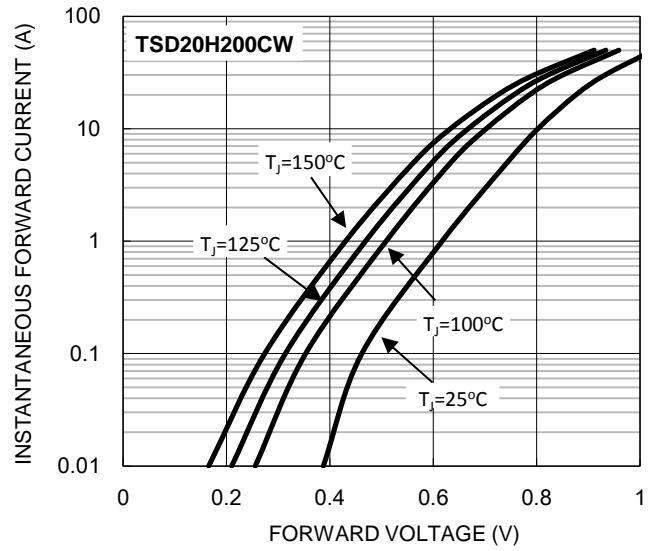
**CHARACTERISTICS CURVES**

( $T_A = 25^\circ\text{C}$  unless otherwise noted)

**Fig.9 Typical Reverse Characteristics**

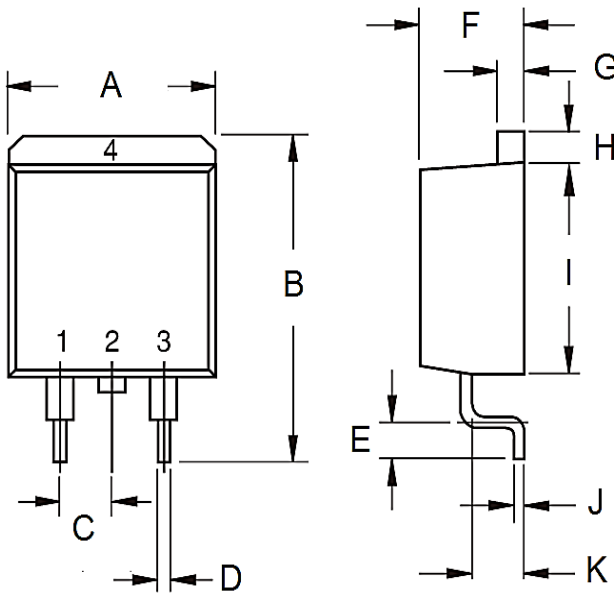


**Fig.10 Typical Forward Characteristics**



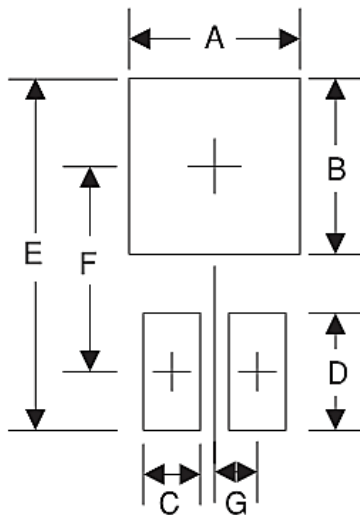
**PACKAGE OUTLINE DIMENSIONS**

TO-263AB (D<sup>2</sup>PAK)



DIM.	Unit (mm)		Unit (inch)	
	Min	Max	Min	Max
A	-	10.5	-	0.413
B	14.60	15.88	0.575	0.625
C	2.41	2.67	0.095	0.105
D	0.68	0.94	0.027	0.037
E	2.29	2.79	0.090	0.110
F	4.44	4.70	0.175	0.185
G	1.14	1.40	0.045	0.055
H	1.14	1.40	0.045	0.055
I	8.25	9.25	0.325	0.364
J	0.36	0.53	0.014	0.021
K	2.03	2.79	0.080	0.110

**SUGGESTED PAD LAYOUT**



Symbol	Unit (mm)	Unit (inch)
A	10.8	0.425
B	8.3	0.327
C	1.1	0.043
D	3.5	0.138
E	16.9	0.665
F	9.5	0.374
G	2.5	0.098

**MARKING DIAGRAM**



- P/N = Marking Code
- G = Green Compound
- YWW = Date Code
- F = Factory Code

## Notice

Specifications of the products displayed herein are subject to change without notice. TSC or anyone on its behalf, assumes no responsibility or liability for any errors or inaccuracies.

Information contained herein is intended to provide a product description only. No license, express or implied, to any intellectual property rights is granted by this document. Except as provided in TSC's terms and conditions of sale for such products, TSC assumes no liability whatsoever, and disclaims any express or implied warranty, relating to sale and/or use of TSC products including liability or warranties relating to fitness for a particular purpose, merchantability, or infringement of any patent, copyright, or other intellectual property right.

The products shown herein are not designed for use in medical, life-saving, or life-sustaining applications. Customers using or selling these products for use in such applications do so at their own risk and agree to fully indemnify TSC for any damages resulting from such improper use or sale.



