

## 3A, 20V - 200V Surface Mount Schottky Barrier Rectifier

### FEATURES

- Low power loss, high efficiency
- Ideal for automated placement
- Guard ring for over-voltage protection
- High surge current capability
- Compliant to RoHS Directive 2011/65/EU and in accordance to WEEE 2002/96/EC
- Halogen-free according to IEC 61249-2-21

### APPLICATIONS

- Switching mode power supply (SMPS)
- Adapters
- Lighting application
- On-board DC/DC converter

### MECHANICAL DATA

- Case: DO-214AC (SMA)
- Molding compound meets UL 94V-0 flammability rating
- Packing code with suffix "G" means green compound (halogen-free)
- Part no. with suffix "H" means AEC-Q101 qualified
- Terminal: Matte tin plated leads, solderable per J-STD-002
- Meet JESD 201 class 2 whisker test
- Polarity: As marked
- Weight: 0.07 g (approximately)

KEY PARAMETERS		
PARAMETER	VALUE	UNIT
$I_{F(AV)}$	3	A
$V_{RRM}$	20 - 200	V
$I_{FSM}$	70	A
$T_{JMAX}$	150	°C
Package	DO-214AC (SMA)	
Configuration	Single die	



**DO-214AC (SMA)**

ABSOLUTE MAXIMUM RATINGS ( $T_A = 25^\circ\text{C}$ unless otherwise noted)											
PARAMETER	SYMBOL	SK 32A	SK 33A	SK 34A	SK 35A	SK 36A	SK 39A	SK 310A	SK 315A	SK 320A	UNIT
Marking code on the device		SK 32A	SK 33A	SK 34A	SK 35A	SK 36A	SK 39A	SK 310A	SK 315A	SK 320A	
Repetitive peak reverse voltage	$V_{RRM}$	20	30	40	50	60	90	100	150	200	V
Reverse voltage, total rms value	$V_{R(RMS)}$	14	21	28	35	42	63	70	105	140	V
Maximum DC blocking voltage	$V_{DC}$	20	30	40	50	60	90	100	150	200	V
Forward current	$I_{F(AV)}$	3									A
Surge peak forward current, 8.3 ms single half sine-wave superimposed on rated load per diode	$I_{FSM}$	70									A
Critical rate of rise of off-state voltage	dV/dt	10,000									V/ $\mu\text{s}$
Junction temperature	$T_J$	- 55 to +150									°C
Storage temperature	$T_{STG}$	- 55 to +150									°C

**THERMAL PERFORMANCE**

PARAMETER	SYMBOL	TYP.	UNIT
Junction-to-ambient thermal resistance	$R_{\theta JA}$	66	°C/W
Junction-to-lead thermal resistance	$R_{\theta JL}$	25	°C/W

**ELECTRICAL SPECIFICATIONS** ( $T_A = 25^\circ\text{C}$  unless otherwise noted)

PARAMETER	CONDITIONS	SYMBOL	TYP.	MAX.	UNIT
Forward voltage per diode <sup>(1)</sup>	$I_F = 3\text{A}, T_J = 25^\circ\text{C}$	$V_F$	-	0.55	V
			-	0.72	V
			-	0.85	V
			-	0.95	V
			-	-	-
Reverse current @ rated $V_R$ per diode <sup>(2)</sup>	$T_J = 25^\circ\text{C}$	$I_R$	-	0.5	mA
			-	0.2	mA
			-	0.1	mA
			-	-	-
			-	-	-
Reverse current @ rated $V_R$ per diode <sup>(2)</sup>	$T_J = 100^\circ\text{C}$	$I_R$	-	10	mA
			-	5	mA
			-	-	mA
			-	-	-
			-	-	-
Reverse current @ rated $V_R$ per diode <sup>(2)</sup>	$T_J = 125^\circ\text{C}$	$I_R$	-	-	mA
			-	10	mA
			-	0.5	mA
			-	-	-
			-	-	-

**Notes:**

1. Pulse test with  $PW=0.3\text{ ms}$
2. Pulse test with  $PW=30\text{ ms}$

**ORDERING INFORMATION**

PART NO.	PART NO. SUFFIX	PACKING CODE	PACKING CODE SUFFIX(*)	PACKAGE	PACKING
SK3xxA (Note 1)	H	R3	G	SMA	1,800 / 7" Plastic reel
		R2		SMA	7,500 / 13" Paper reel
		M2		SMA	7,500 / 13" Plastic reel
		F3		Folded SMA	1,800 / 7" Plastic reel
		F2		Folded SMA	7,500 / 13" Paper reel
		F4		Folded SMA	7,500 / 13" Plastic reel
		E3		Clip SMA	1,800 / 7" Plastic reel
		E2		Clip SMA	7,500 / 13" Paper reel

**Note:**

1. "xx" defines voltage from 20V (SK32A) to 200V (SK320A)

\*: Optional available

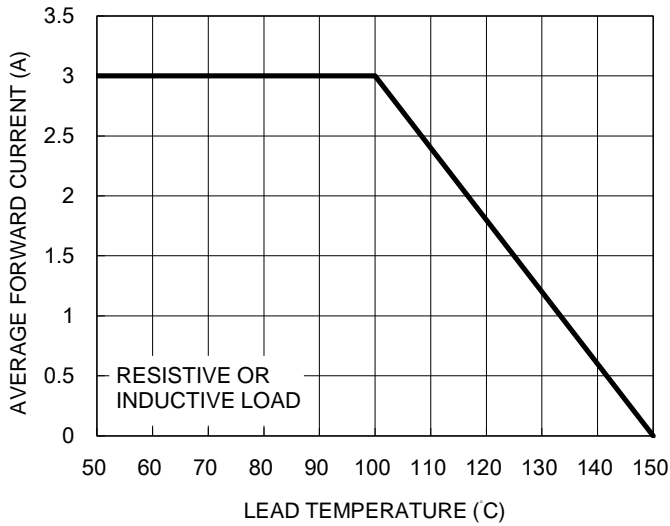
**EXAMPLE P/N**

EXAMPLE P/N	PART NO.	PART NO. SUFFIX	PACKING CODE	PACKING CODE SUFFIX	DESCRIPTION
SK36AHR3G	SK36A	H	R3	G	AEC-Q101 qualified Green compound

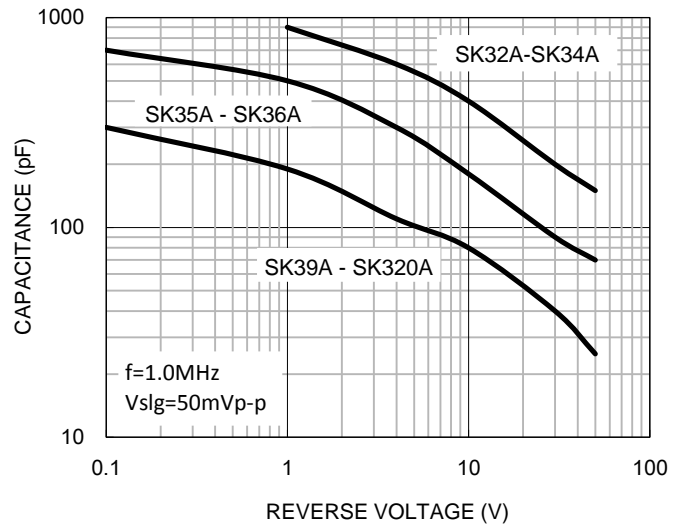
**CHARACTERISTICS CURVES**

( $T_A = 25^\circ\text{C}$  unless otherwise noted)

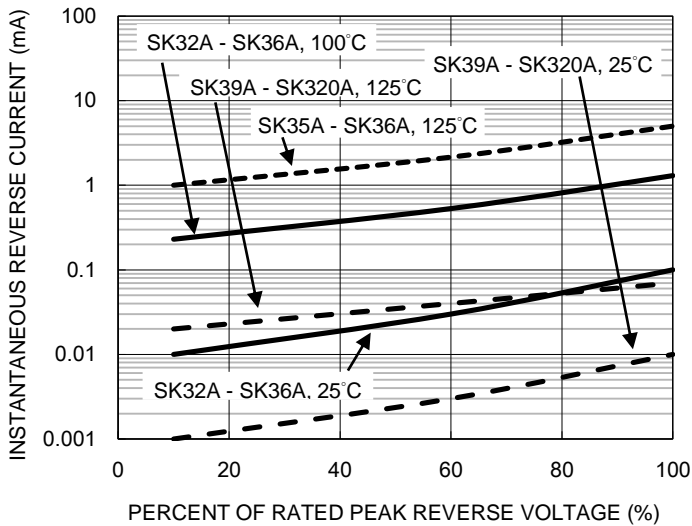
**Fig.1 Forward Current Derating Curve**



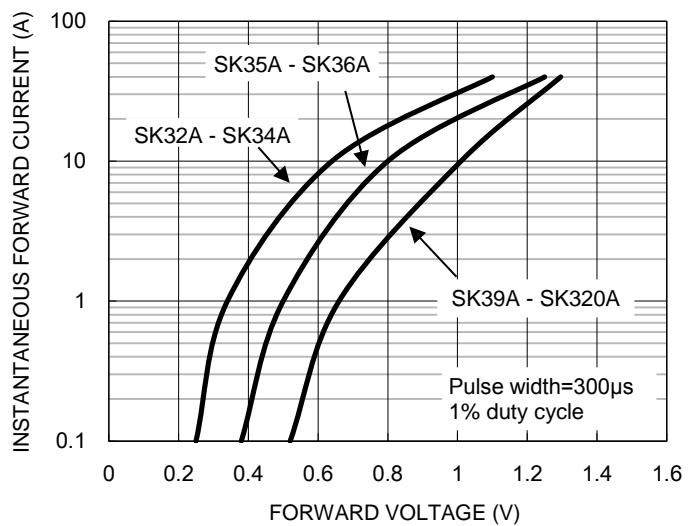
**Fig.2 Typical Junction Capacitance**



**Fig.3 Typical Reverse Characteristics**



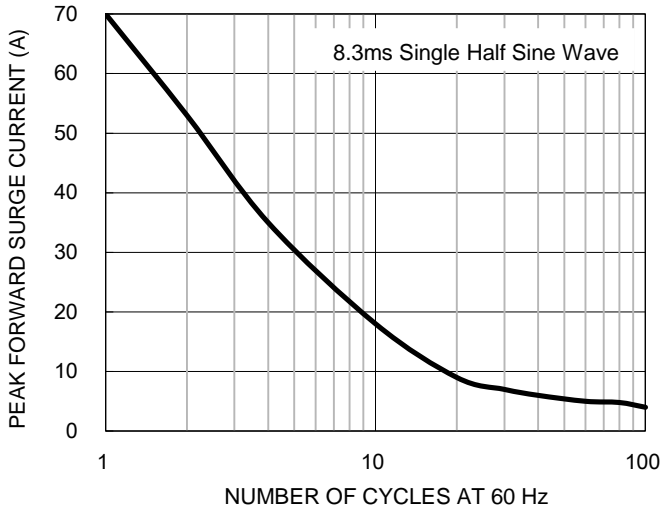
**Fig.4 Typical Forward Characteristics**



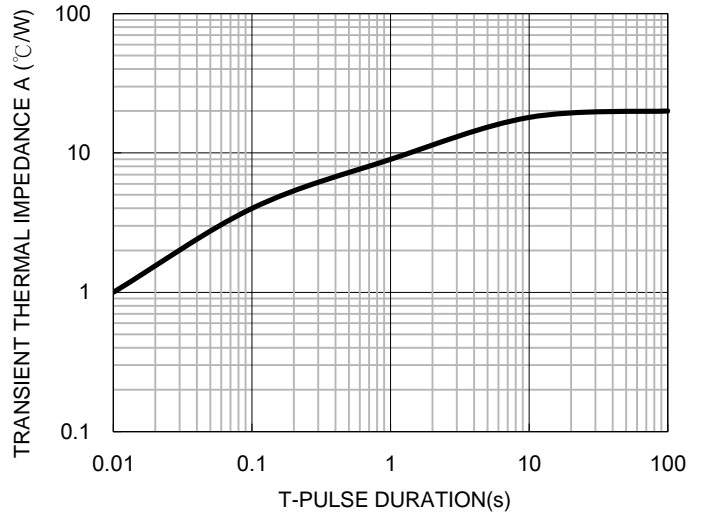
**CHARACTERISTICS CURVES**

( $T_A = 25^\circ\text{C}$  unless otherwise noted)

**Fig.5 Maximum Non-repetitive Forward Surge Current**

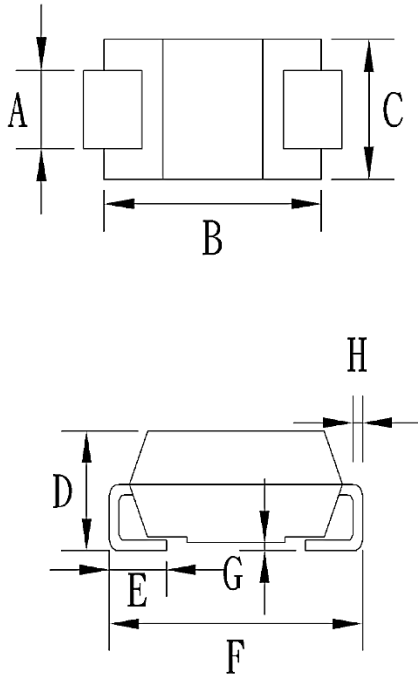


**Fig.6 Typical Transient Thermal Characteristics**



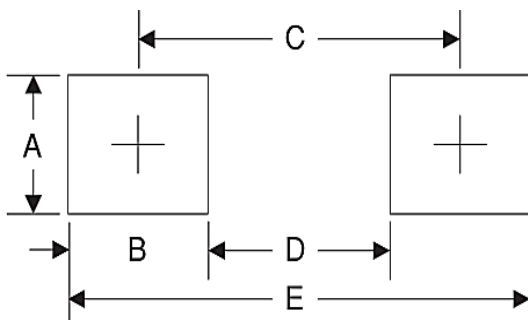
**PACKAGE OUTLINE DIMENSIONS**

DO-214AC (SMA)



DIM.	Unit (mm)		Unit (inch)	
	Min	Max	Min	Max
A	1.27	1.58	0.050	0.062
B	4.06	4.60	0.160	0.181
C	2.29	2.83	0.090	0.111
D	1.99	2.50	0.078	0.098
E	0.90	1.41	0.035	0.056
F	4.95	5.33	0.195	0.210
G	0.10	0.20	0.004	0.008
H	0.15	0.31	0.006	0.012

**SUGGESTED PAD LAYOUT**



Symbol	Unit (mm)	Unit (inch)
A	1.68	0.066
B	1.52	0.060
C	3.93	0.155
D	2.41	0.095
E	5.45	0.215

**MARKING DIAGRAM**



- P/N = Marking Code
- G = Green Compound
- YW = Date Code
- F = Factory Code

## Notice

Specifications of the products displayed herein are subject to change without notice. TSC or anyone on its behalf, assumes no responsibility or liability for any errors or inaccuracies.

Information contained herein is intended to provide a product description only. No license, express or implied, to any intellectual property rights is granted by this document. Except as provided in TSC's terms and conditions of sale for such products, TSC assumes no liability whatsoever, and disclaims any express or implied warranty, relating to sale and/or use of TSC products including liability or warranties relating to fitness for a particular purpose, merchantability, or infringement of any patent, copyright, or other intellectual property right.

The products shown herein are not designed for use in medical, life-saving, or life-sustaining applications. Customers using or selling these products for use in such applications do so at their own risk and agree to fully indemnify TSC for any damages resulting from such improper use or sale.