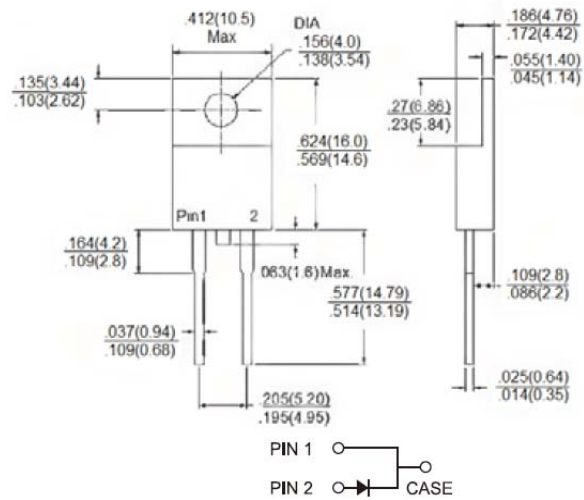

TO-220AC

Features

- ◇ High efficiency, low VF
- ◇ High current capability
- ◇ High reliability
- ◇ High surge current capability
- ◇ Low power loss
- ◇ For use in low voltage, high frequency inverter, Free wheeling, and polarity protection application
- ◇ Green compound with suffix "G" on packing code & prefix "G" on datecode

Mechanical Data

- ◇ Case: TO-220AC Molded plastic
- ◇ Epoxy: UL 94V-0 rate flame retardant
- ◇ Terminals: Pure tin plated, lead free, solderable per MIL-STD-202, Method 208 guaranteed
- ◇ Polarity: As marked
- ◇ High temperature soldering: 260°C/10 seconds/.16"(.4.06mm) from case
- ◇ Weight: 1.9 grams

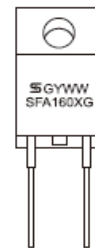
Dimensions in inches and (millimeters)
Marking Diagram

- SFA160XG = Specific Device Code
- G = Green Compound
- Y = Year
- WW = Work Week

Maximum Ratings and Electrical Characteristics

Rating at 25 °C ambient temperature unless otherwise specified.

Single phase, half wave, 60 Hz, resistive or inductive load.

For capacitive load, derate current by 20%

Type Number	Symbol	SFA 1601G	SFA 1602G	SFA 1603G	SFA 1604G	SFA 1605G	SFA 1606G	SFA 1607G	SFA 1608G	Unit
Maximum Repetitive Peak Reverse Voltage	V_{RRM}	50	100	150	200	300	400	500	600	V
Maximum RMS Voltage	V_{RMS}	35	70	105	140	210	280	350	420	V
Maximum DC Blocking Voltage	V_{DC}	50	100	150	200	300	400	500	600	V
Maximum Average Forward Rectified Current	$I_{F(AV)}$	16								A
Peak Forward Surge Current, 8.3 ms Single Half Sine-wave Superimposed on Rated Load (JEDEC method)	I_{FSM}	200								A
Maximum Instantaneous Forward Voltage (Note 1) @ 16 A	V_F	0.975			1.3		1.7			V
Maximum Reverse Current @ Rated VR $T_A=25\text{ }^\circ\text{C}$ $T_A=100\text{ }^\circ\text{C}$	I_R	10				400				uA
Maximum Reverse Recovery Time (Note 2)	T_{rr}	35								nS
Typical Junction Capacitance (Note 3)	C_j	130				100				pF
Typical Thermal Resistance	$R_{\theta JC}$	1								°C/W
Operating Temperature Range	T_J	- 65 to + 150								°C
Storage Temperature Range	T_{STG}	- 65 to + 150								°C

Note 1: Pulse Test with PW=300 usec, 1% Duty Cycle

 Note 2: Reverse Recovery Test Conditions: $I_F=0.5A$, $I_R=1.0A$, $I_{RR}=0.25A$

Note 3: Measured at 1 MHz and Applied Reverse Voltage of 4.0V D.C.

RATINGS AND CHARACTERISTIC CURVES (SFA1601G THRU SFA1608G)

FIG.1 FORWARD CURRENT DERATING CURVE

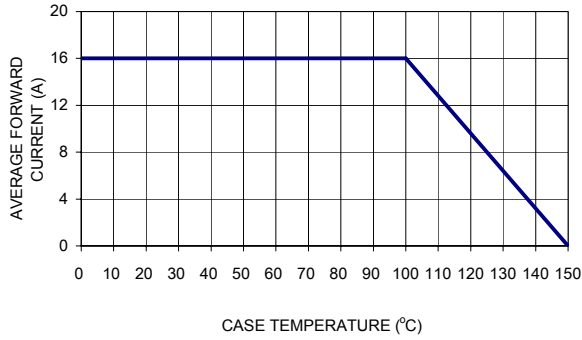

FIG. 2 TYPICAL REVERSE CHARACTERISTICS

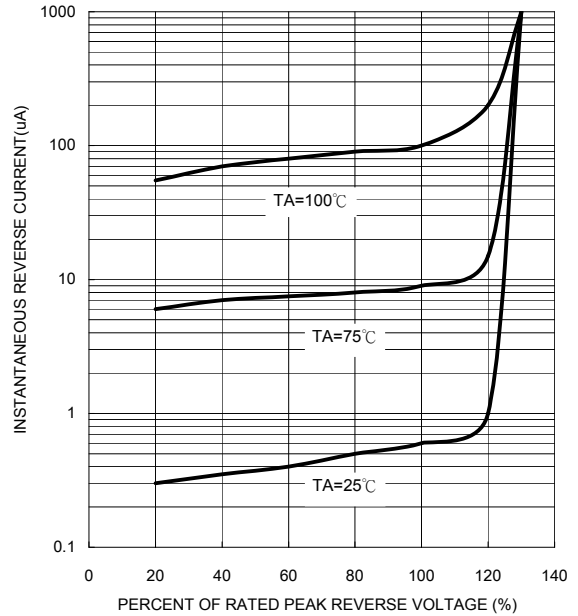

FIG. 3 MAXIMUM NON-REPETITIVE FORWARD SURGE CURRENT

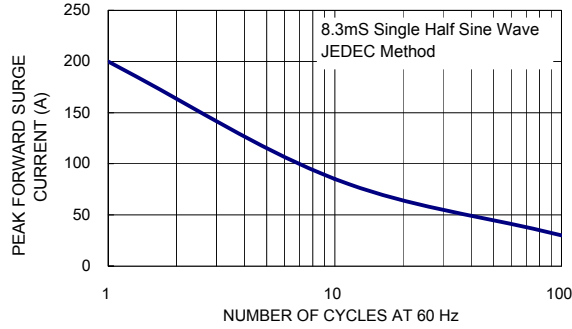

FIG. 5 TYPICAL FORWARD CHARACTERISTICS

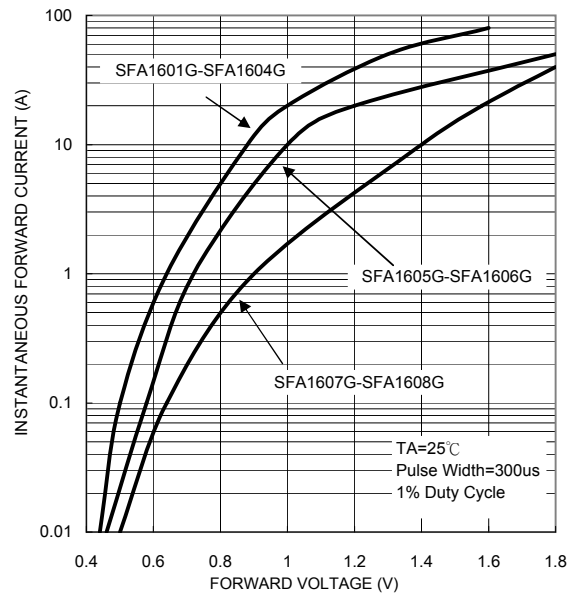

FIG. 4 TYPICAL JUNCTION CAPACITANCE

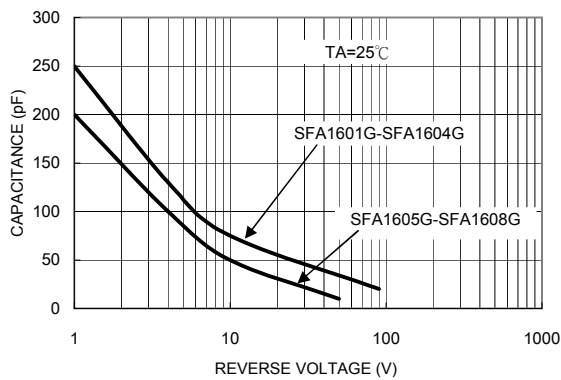

FIG.6- REVERSE RECOVERY TIME CHARACTERISTIC AND TEST CIRCUIT DIAGRAM

