

## 40 V, 1 A low drop power Schottky rectifier

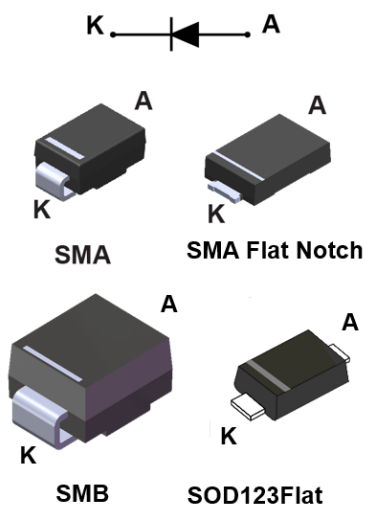

### Features

- Very small conduction losses
- Negligible switching losses
- Low forward voltage drop
- Surface mount miniature packages
- Avalanche rated
- ECOPACK2 compliant

### Applications

- Reverse polarity protection
- Set-top box power supply
- TV power supply
- Battery charger

### Description

Single chip Schottky rectifiers suited to switched mode power supplies and high frequency DC to DC converters.

Packaged in SMA, SMA Flat Notch, SMB and SOD123Flat, the **STPS1L40** is ideal for use in surface mounting and used in low voltage, high frequency inverters, free-wheeling and polarity protection applications.

| Product status  |        |
|-----------------|--------|
| STPS1L40        |        |
| Product summary |        |
| Symbol          | Value  |
| $I_{F(AV)}$     | 1 A    |
| $V_{RRM}$       | 40 V   |
| $T_{j(max.)}$   | 175 °C |
| $V_{F(typ.)}$   | 0.37 V |

# 1 Characteristics

**Table 1. Absolute ratings (limiting values at 25 °C, unless otherwise specified)**

| Symbol       | Parameter  |  | Value       | Unit |
|--------------|--|--|-------------|------|
| $V_{RRM}$    | Repetitive peak reverse voltage                      |  | 40          | V    |
| $I_{F(RMS)}$ | Forward rms current                                  | SMA/SMB  | 8           | A    |
| $I_{F(AV)}$  | Average forward current $\delta = 0.5$ , square wave | SMA/SMB $T_L = 155\text{ °C}$                      | 1           | A    |
|              |  | SMA Flat Notch $T_L = 160\text{ °C}$               |             |      |
|              |  | SOD123Flat $T_L = 160\text{ °C}$                   |             |      |
| $I_{FSM}$    | Surge non repetitive forward current                 | SMA/SMB  | 60          | A    |
|              |  | SMA Flat Notch $t_p = 10\text{ ms sinusoidal}$     | 60          |      |
|              |  | SOD123Flat   | 50          |      |
| $P_{ARM}$    | Repetitive peak avalanche power                      | $t_p = 10\text{ }\mu\text{s}, T_j = 125\text{ °C}$ | 65          | W    |
| $T_{stg}$    | Storage temperature range                            |  | -65 to +175 | °C   |
| $T_j$        | Operating junction temperature <sup>(1)</sup>        |  | +175        | °C   |

1.  $(dP_{tot}/dT_j) < (1/R_{th(j-a)})$  condition to avoid thermal runaway for a diode on its own heatsink.

**Table 2. Thermal resistance parameter**

| Symbol        | Parameter        |                | Max. value | Unit |
|---------------|------------------|----------------|------------|------|
| $R_{th(j-l)}$ | Junction to lead | SMA            | 30         | °C/W |
|               |                  | SMA Flat Notch | 20         |      |
|               |                  | SMB            | 25         |      |
|               |                  | SOD123Flat     | 20         |      |

For more information, please refer to the following application note :

- AN5088 : Rectifiers thermal management, handling and mounting recommendations

**Table 3. Static electrical characteristics**

| Symbol      | Parameter               | Test conditions       |                    | Min. | Typ. | Max. | Unit          |
|-------------|-------------------------|-----------------------|--------------------|------|------|------|---------------|
| $I_R^{(1)}$ | Reverse leakage current | $T_j = 25\text{ °C}$  | $V_R = V_{RRM}$    | -    |      | 35   | $\mu\text{A}$ |
|             |                         | $T_j = 125\text{ °C}$ |                    | -    | 6    | 10   | mA            |
| $V_F^{(1)}$ | Forward voltage drop    | $T_j = 25\text{ °C}$  | $I_F = 1\text{ A}$ | -    |      | 0.50 | V             |
|             |                         | $T_j = 125\text{ °C}$ |                    | -    | 0.37 | 0.42 |               |
|             |                         | $T_j = 25\text{ °C}$  | $I_F = 2\text{ A}$ | -    |      | 0.63 |               |
|             |                         | $T_j = 125\text{ °C}$ |                    | -    | 0.50 | 0.61 |               |

1. Pulse test:  $t_p = 380\text{ }\mu\text{s}$ ,  $\delta < 2\%$

To evaluate the conduction losses, use the following equation:

$$P = 0.23 \times I_{F(AV)} + 0.19 \times I_{F(RMS)}^2$$

For more information, please refer to the following application notes related to the power losses :

- AN604: Calculation of conduction losses in a power rectifier
- AN4021: Calculation of reverse losses on a power diode

## 1.1 Characteristics (curves)

**Figure 1. Average forward power dissipation versus average forward current**

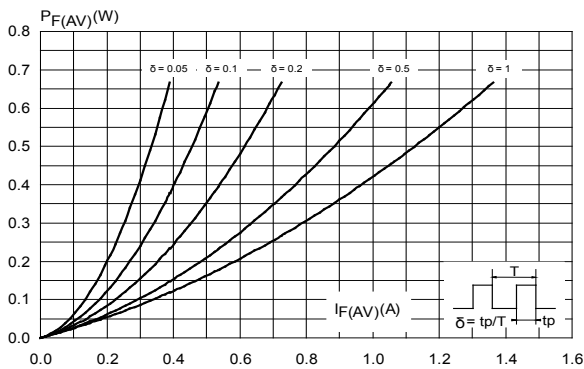

**Figure 2. Average forward current versus ambient temperature (SMA,  $\delta = 0.5$ )**

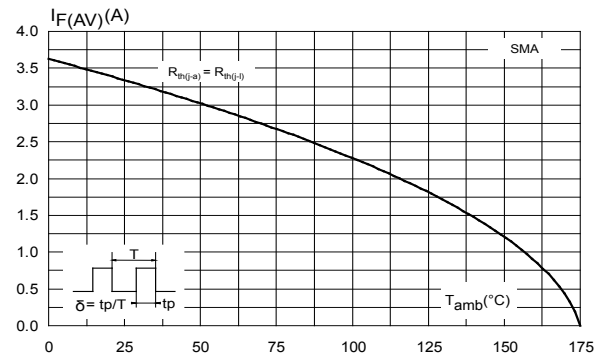

**Figure 3. Average forward current versus ambient temperature (SMB,  $\delta = 0.5$ )**

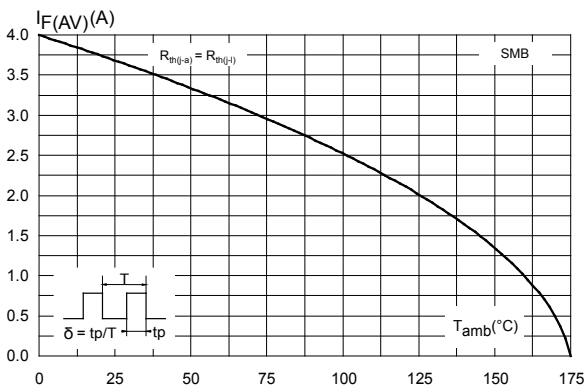

**Figure 4. Average forward current versus ambient temperature (SOD123Flat, SMA Flat Notch,  $\delta = 0.5$ )**

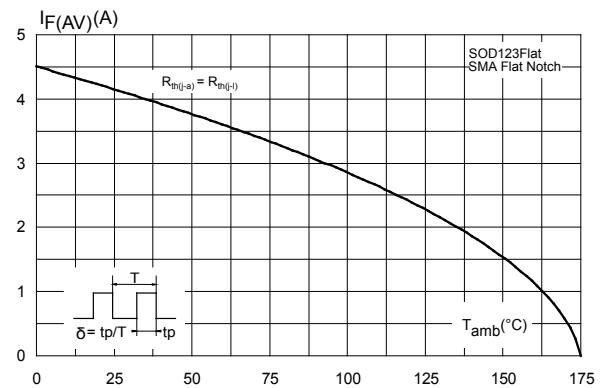

**Figure 5. Normalized avalanche power derating versus pulse duration ( $T_j = 125\text{ }^\circ\text{C}$ )**

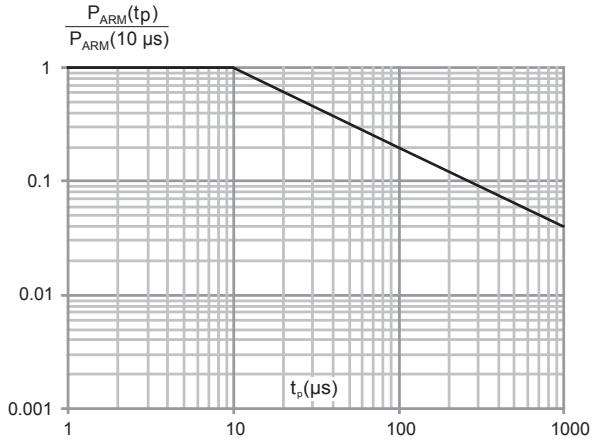

**Figure 6. Relative variation of thermal impedance junction to ambient versus pulse duration (SMA)**

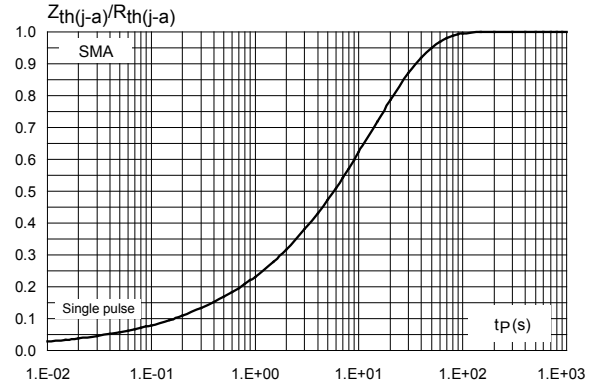

**Figure 7. Relative variation of thermal impedance junction to ambient versus pulse duration (SMB)**

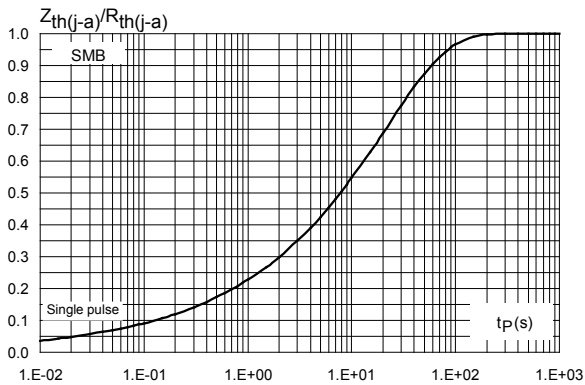

**Figure 8. Relative variation of thermal impedance junction to lead versus pulse duration (SOD123Flat)**

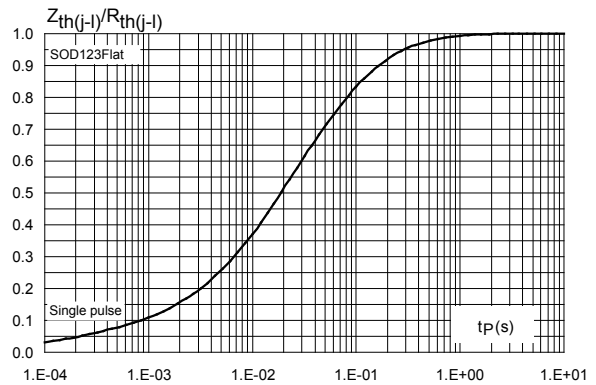

**Figure 9. Reverse leakage current versus reverse voltage applied (typical values)**

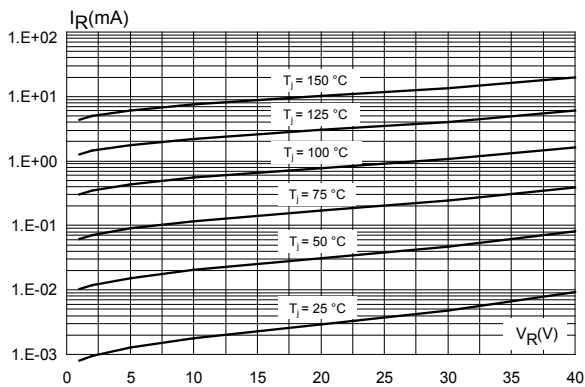

**Figure 10. Junction capacitance versus reverse voltage applied (typical values)**

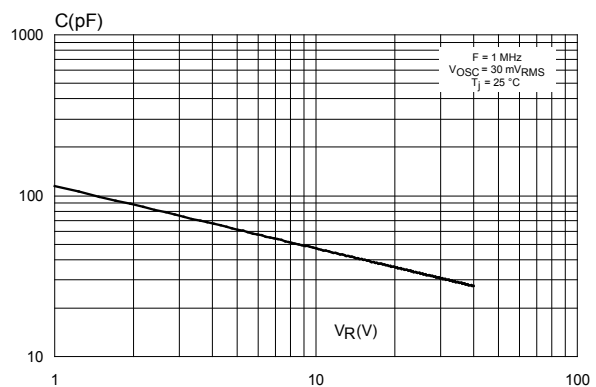

**Figure 11. Forward voltage drop versus forward current (typical values)**

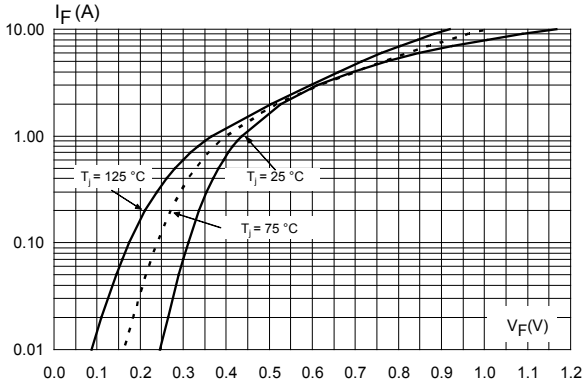

**Figure 12. Thermal resistance junction to ambient versus copper surface under each lead (typical values)**

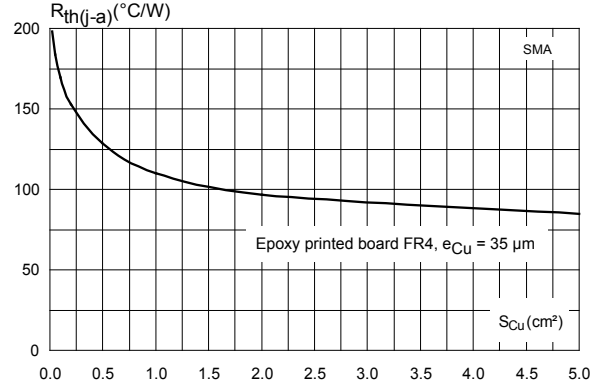

**Figure 13. Thermal resistance junction to ambient versus copper surface under each lead (typical values)**

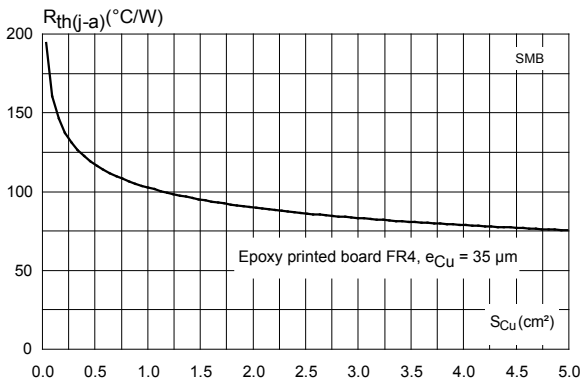

**Figure 14. Thermal resistance junction to ambient versus copper surface under each lead (typical values)**

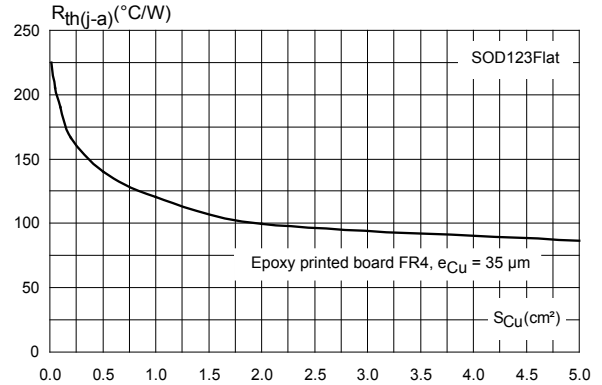

**Figure 15. Thermal resistance junction to ambient versus copper surface under each lead (SMA Flat Notch)**

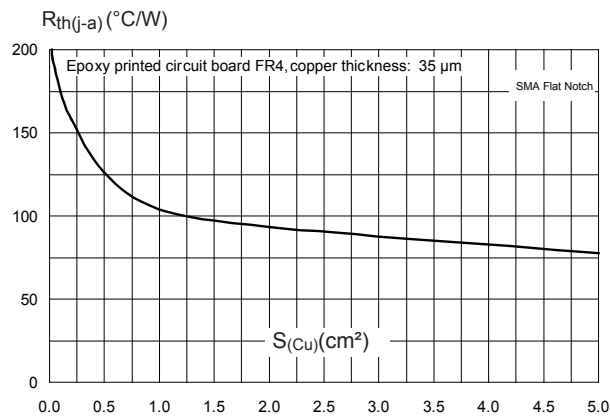

## 2 Package information

In order to meet environmental requirements, ST offers these devices in different grades of **ECOPACK** packages, depending on their level of environmental compliance. ECOPACK specifications, grade definitions and product status are available at: [www.st.com](http://www.st.com). ECOPACK is an ST trademark.

### 2.1 SMB package information

- Epoxy meets UL94, V0
- Lead-free package

**Figure 16. SMB package outline**

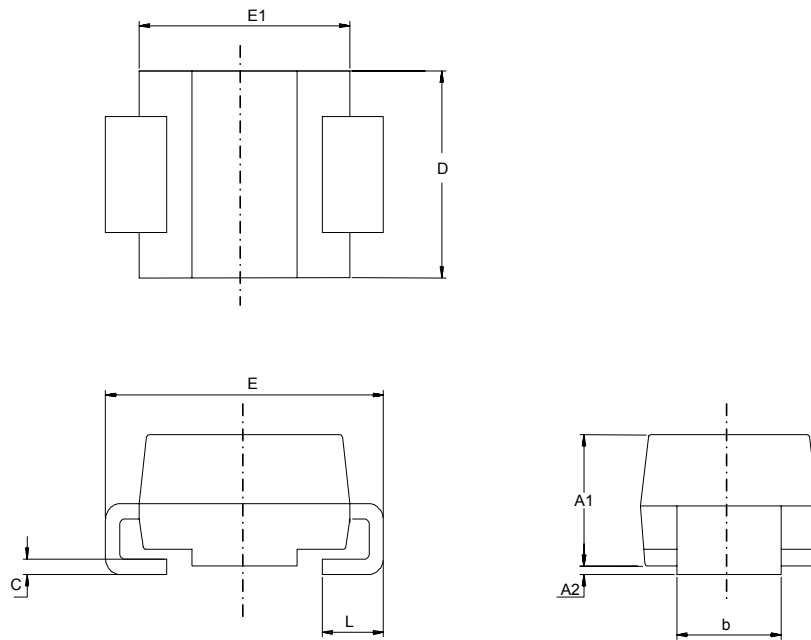

**Table 4. SMB package mechanical data**

| Ref. | Dimensions  |      |                             |       |
|------|-------------|------|-----------------------------|-------|
|      | Millimeters |      | Inches (for reference only) |       |
|      | Min.        | Max. | Min.                        | Max.  |
| A1   | 1.90        | 2.45 | 0.074                       | 0.097 |
| A2   | 0.05        | 0.20 | 0.001                       | 0.008 |
| b    | 1.95        | 2.20 | 0.076                       | 0.087 |
| c    | 0.15        | 0.40 | 0.005                       | 0.016 |
| D    | 3.30        | 3.95 | 0.129                       | 0.156 |
| E    | 5.10        | 5.60 | 0.200                       | 0.221 |
| E1   | 4.05        | 4.60 | 0.159                       | 0.182 |
| L    | 0.75        | 1.50 | 0.029                       | 0.060 |

**Figure 17. SMB recommended footprint**

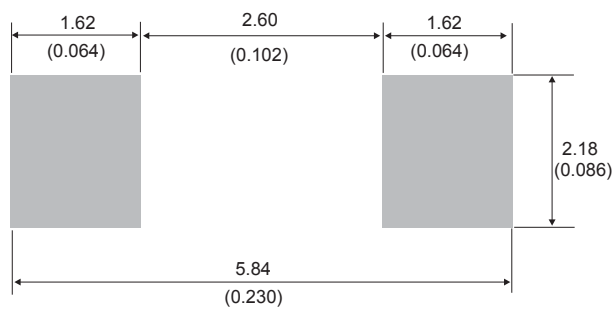

## 2.2 SMA package information

- Epoxy meets UL94, V0
- Cooling method : by conduction (C)

**Figure 18. SMA package outline**

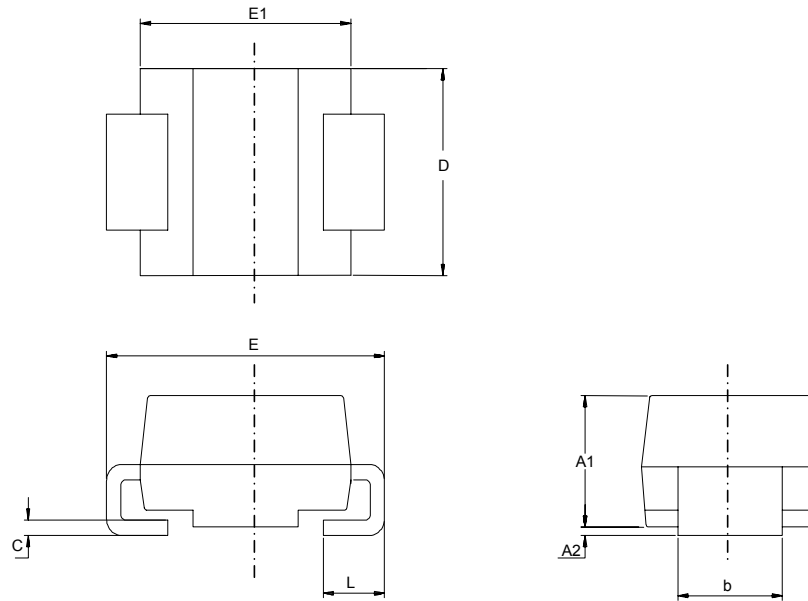
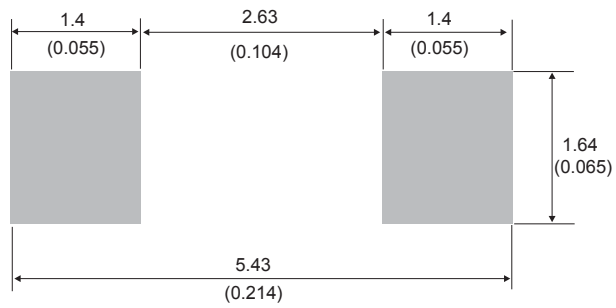

**Table 5. SMA package mechanical data**

| Ref. | Dimensions  |      |                             |       |
|------|-------------|------|-----------------------------|-------|
|      | Millimeters |      | Inches (for reference only) |       |
|      | Min.        | Max. | Min.                        | Max.  |
| A1   | 1.90        | 2.45 | 0.074                       | 0.097 |
| A2   | 0.05        | 0.20 | 0.001                       | 0.008 |
| b    | 1.25        | 1.65 | 0.049                       | 0.065 |
| c    | 0.15        | 0.40 | 0.005                       | 0.016 |
| D    | 2.25        | 2.90 | 0.088                       | 0.115 |
| E    | 4.80        | 5.35 | 0.188                       | 0.211 |
| E1   | 3.95        | 4.60 | 0.155                       | 0.182 |
| L    | 0.75        | 1.50 | 0.029                       | 0.060 |



**Figure 19. SMA recommended footprint in mm (inches)**



### 2.3 SMA Flat Notch package information

- Epoxy meets UL94, V0
- Cooling method: by conduction (C)
- Band indicates cathode

Figure 20. SMA Flat Notch package outline

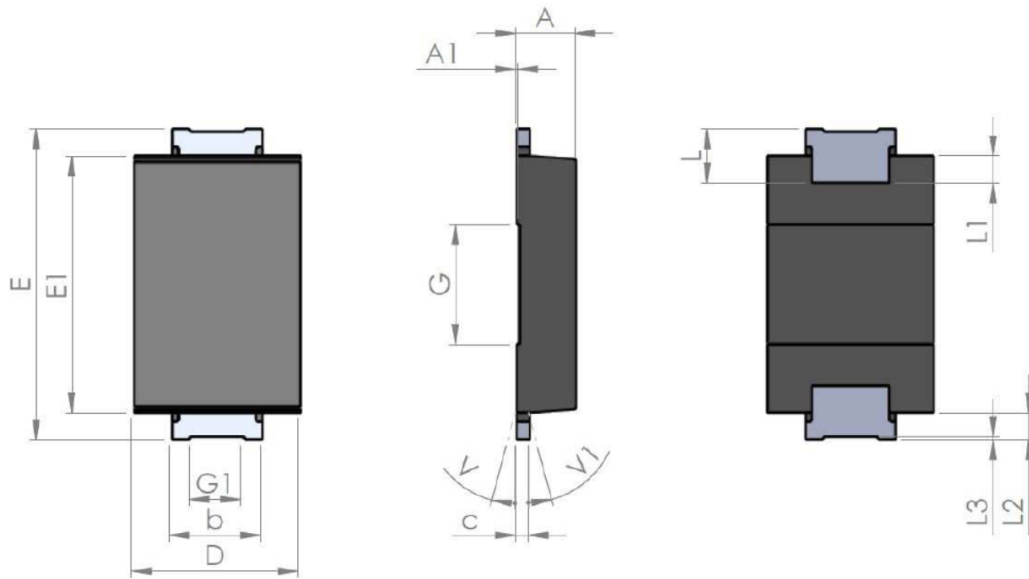
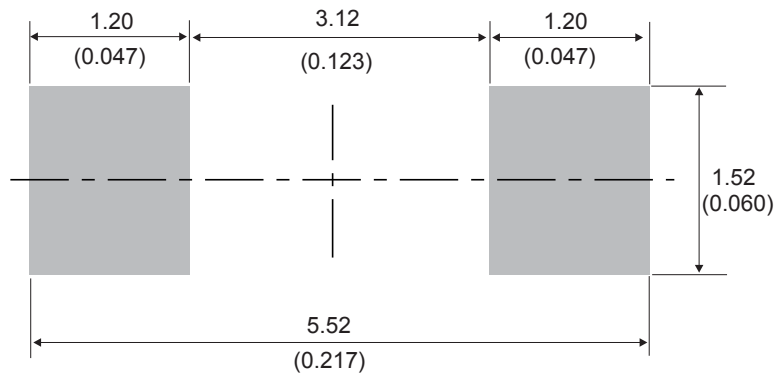

Table 6. SMA Flat Notch package mechanical data

| Ref. | Dimensions  |      |      |                             |       |       |
|------|-------------|------|------|-----------------------------|-------|-------|
|      | Millimeters |      |      | Inches (for reference only) |       |       |
|      | Min.        | Typ. | Max. | Min.                        | Typ.  | Max.  |
| A1   | 0.90        |      | 1.10 | 0.035                       |       | 0.044 |
| A1   |             | 0.05 |      |                             | 0.002 |       |
| b    | 1.25        |      | 1.65 | 0.049                       |       | 0.065 |
| C    | 0.15        |      | 0.40 | 0.005                       |       | 0.016 |
| D    | 2.25        |      | 2.90 | 0.088                       |       | 0.115 |
| E    | 5.00        |      | 5.35 | 0.196                       |       | 0.211 |
| E1   | 3.95        |      | 4.60 | 0.155                       |       | 0.182 |
| G    |             | 2.00 |      |                             | 0.079 |       |
| G1   |             | 0.85 |      |                             | 0.033 |       |
| L    | 0.75        |      | 1.20 | 0.029                       |       |       |
| L1   |             | 0.45 |      |                             | 0.018 |       |
| L2   |             | 0.45 |      |                             | 0.018 |       |
| L3   |             | 0.05 |      |                             | 0.002 |       |
| V    |             |      | 8°   |                             |       | 8°    |
| V1   |             |      | 8°   |                             |       | 8°    |

Figure 21. SMA Flat Notch recommended footprint in mm (inches)



## 2.4 SOD123Flat package information

Figure 22. SOD123Flat package outline

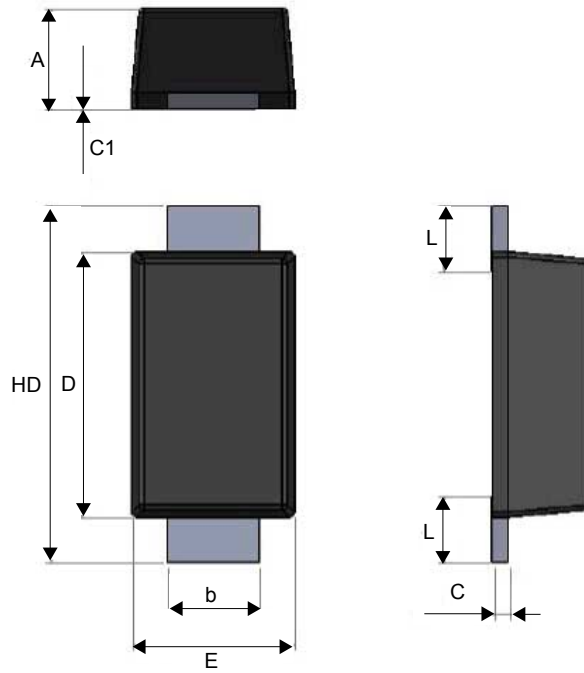
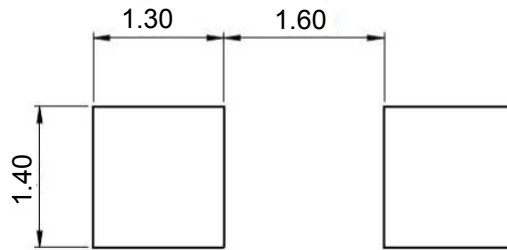

Table 7. SOD123Flat package mechanical data

| Ref. | Dimensions  |      |      |                             |       |       |
|------|-------------|------|------|-----------------------------|-------|-------|
|      | Millimeters |      |      | Inches (for reference only) |       |       |
|      | Min.        | Typ. | Max. | Min.                        | Typ.  | Max.  |
| A    | 0.86        | 0.98 | 1.10 | 0.034                       | 0.038 | 0.043 |
| b    | 0.80        | 0.90 | 1.00 | 0.031                       | 0.035 | 0.039 |
| c    | 0.08        | 0.15 | 0.25 | 0.003                       | 0.006 | 0.009 |
| c1   | 0.00        |      | 0.10 | 0.000                       |       | 0.004 |
| D    | 2.50        | 2.60 | 2.70 | 0.098                       | 0.102 | 0.106 |
| E    | 1.50        | 1.60 | 1.80 | 0.059                       | 0.063 | 0.070 |
| HD   | 3.30        | 3.50 | 3.70 | 0.130                       | 0.137 | 0.146 |
| L    | 0.45        | 0.65 | 0.85 | 0.018                       | 0.025 | 0.033 |

Figure 23. SOD123Flat footprint dimensions (mm)



### 3 Ordering information

**Table 8. Ordering information**

| Order code  | Marking | Package        | Weight  | Base qty. | Delivery mode |
|-------------|---------|----------------|---------|-----------|---------------|
| STPS1L40U   | GC4     | SMB            | 107 mg  | 2500      | Tape and reel |
| STPS1L40A   | GB4     | SMA            | 68 mg   | 5000      | Tape and reel |
| STPS1L40AFN | A14     | SMA Flat Notch | 39 mg   | 10 000    | Tape and reel |
| STPS1L40ZF  | 1L4     | SOD123Flat     | 12.5 mg | 3000      | Tape and reel |

## Revision history

**Table 9. Document revision history**

| Date        | Revision | Changes   |
|-------------|----------|---|
| Jul-2003    | 4A       | Last update.  |
| Aug-2004    | 5        | SMA package dimensions update. Reference A1 max. changed from 2.70 mm (0.106 inch.) to 2.03 mm (0.080).   |
| 24-Jun-2009 | 6        | Added STmite flat package.  |
| 01-Jul-2016 | 7        | STmite flat package information removed.<br>Added SOD123Flat package.   |
| 03-Dec-2018 | 8        | Updated <a href="#">Section Features</a> and <a href="#">Table 1. Absolute ratings (limiting values at 25 °C, unless otherwise specified)</a> . |
| 27-Sep-2019 | 9        | Added <a href="#">Section 2.3 SMA Flat Notch package information</a> .  |

**IMPORTANT NOTICE – PLEASE READ CAREFULLY**

STMicroelectronics NV and its subsidiaries (“ST”) reserve the right to make changes, corrections, enhancements, modifications, and improvements to ST products and/or to this document at any time without notice. Purchasers should obtain the latest relevant information on ST products before placing orders. ST products are sold pursuant to ST’s terms and conditions of sale in place at the time of order acknowledgement.

Purchasers are solely responsible for the choice, selection, and use of ST products and ST assumes no liability for application assistance or the design of Purchasers’ products.

No license, express or implied, to any intellectual property right is granted by ST herein.

Resale of ST products with provisions different from the information set forth herein shall void any warranty granted by ST for such product.

ST and the ST logo are trademarks of ST. For additional information about ST trademarks, please refer to [www.st.com/trademarks](http://www.st.com/trademarks). All other product or service names are the property of their respective owners.

Information in this document supersedes and replaces information previously supplied in any prior versions of this document.

© 2019 STMicroelectronics – All rights reserved