

Aerospace 0.3 A - 100 V switching diode

Datasheet - production data

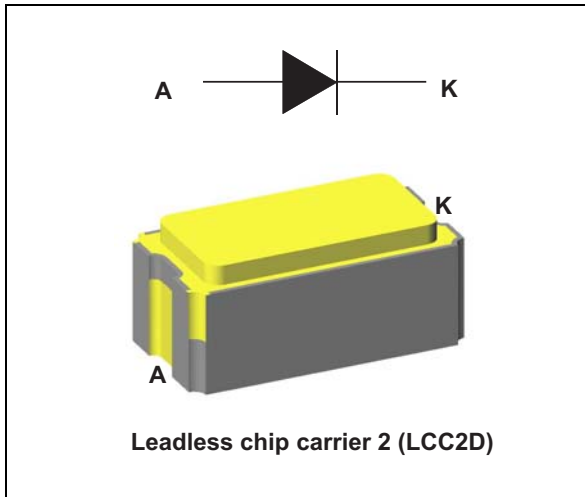

Description

This power ultrafast recovery rectifier is designed and packaged to comply with the ESCC5000 specification for aerospace products. It is housed in a surface mount hermetically sealed LCC2D package whose footprint is 100% compatible with industry standard solutions in D5A.

The 1N6642U is suitable for switching mode power supplies and high frequency DC to DC converters such as low voltage high frequency inverter, free wheeling or polarity protection.

Features

- Surface mount hermetic package
- High thermal conductivity materials
- Very small conduction losses
- Negligible switching losses
- Extremely fast switching
- Low forward voltage drop
- Target radiation qualification
 - 150 krad (Si) low dose rate
 - 3 Mrad (Si) high dose rate
- Package mass: 0.12 g

Table 1. Device summary⁽¹⁾

Order code	ESCC detailed specification	Quality level	Lead finish	EPPL	$I_{F(AV)}$	V_{RRM}	$T_{j(max)}$	$V_{F(max)}$
1N6642UD1		Engineering model	Gold		0.3	100	175	1,2
1N6642U01D	5101/026/07	ESCC	Gold	Yes				
1N6642U02D	5101/026/08	ESCC	Solder dip	Yes				

1. Contact ST sales office for information about the specific conditions for products in die form.

1 Characteristics

Table 2. Absolute ratings (limiting values)

Symbol	Parameter	Value	Unit
V_{RRM}	Repetitive peak reverse voltage	100	V
$I_{F(RMS)}$	Forward rms current	0.5	A
$I_{F(AV)}$	Average forward rectified current ⁽¹⁾	300	mA
I_{FSM}	Forward surge current	$t_p = 8.3$ ms sinusoidal, $t_{amb} \leq 25$ °C	2 A
T_{stg}	Storage temperature range	-65 to +175	°C
T_j	Operating junction temperature range	-65 to +175	°C
T_{sol}	Maximum soldering temperature ⁽²⁾	245	°C

- For all variants at $T_c \geq +155$ °C per diode, derate linearly to 0 A at +175 °C.
- Maximum duration 5 s. The same package must not be re-soldered until 3 minutes have elapsed.

Table 3. Thermal resistance

Symbol	Parameter	Value	Unit
$R_{th(j-c)}$	Junction to case ⁽¹⁾	60	°C/W
$R_{th(j-a)}$	Junction to ambient	280	

- Package mounted on infinite heatsink

Table 4. Static electrical characteristics

Symbol	Parameter	Tests conditions		Min.	Typ.	Max.	Unit
$V_{BR}^{(1)}$	Breakdown voltage	$T_j = 25$ °C	$I_R = 100$ µA	100	-	-	V
$I_R^{(1)}$	Reverse current	$T_j = 25$ °C	$V_R = 20$ V	-	-	25	nA
		$T_j = 25$ °C	$V_R = 75$ V	-	-	50	nA
		$T_j = 150$ °C	$V_R = 20$ V	-	-	30	µA
		$T_j = 150$ °C	$V_R = 75$ V	-	-	40	µA
$V_F^{(2)}$	Forward voltage	$T_j = 25$ °C	$I_F = 10$ mA	-	-	800	mV
		$T_j = 25$ °C	$I_F = 100$ mA	-	-	1200	
		$T_j = 150$ °C	$I_F = 10$ mA	-	-	800	
		$T_j = -55$ °C	$I_F = 100$ mA	-	-	1200	

- Pulse test: $t_p = 10$ ms, $\delta < 2\%$
- Pulse test: $t_p = 680$ µs, $\delta < 2\%$

To evaluate the conduction losses use the following equation:

$$P = 0.74 \times I_{F(AV)} + 1.00 \times I_{F(RMS)}^2$$

Table 5. Dynamic characteristics

Symbol	Parameter	Test conditions	Min.	Typ.	Max.	Unit
t_{rr}	Reverse recovery time	$I_F = I_R = 10 \text{ mA}^{(1)}$	-	-	9	ns
		$I_F = 1 \text{ A}, V_f = 30 \text{ V}, dI/dt = -15 \text{ A}/\mu\text{s}$	-	-	20	
V_{FP}	Forward recovery voltage	$I_{FM} = 200 \text{ mA}$	-	-	5	V
t_{FR}	Forward recovery time	$I_{FM} = 200 \text{ mA}$	-	-	20	ns
C_j	Diode capacitance	$V_R = 0 \text{ V}, V = 50 \text{ mV}, F = 1 \text{ MHz}$	-	-	5	pF
		$V_R = 1.5 \text{ V}, V = 50 \text{ mV}, F = 1 \text{ MHz}$	-	-	2.8	

1. Guaranteed but not tested

Figure 1. Forward voltage drop versus forward current (typical values)

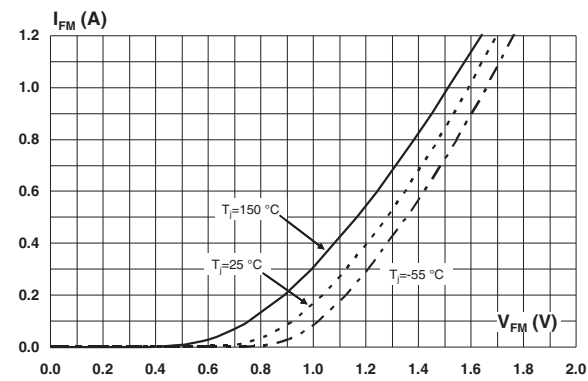

Figure 2. Forward voltage drop versus forward current (maximum values)

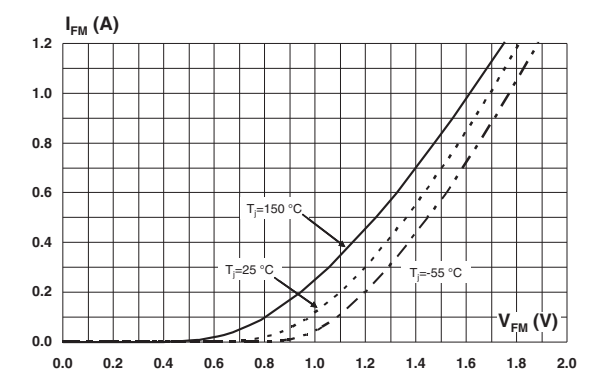

Figure 3. Reverse leakage current versus reverse voltage applied (typical values)

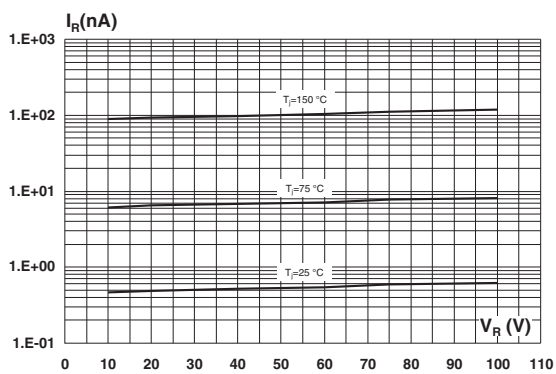

Figure 4. Relative variation of thermal impedance, junction to case, versus pulse duration

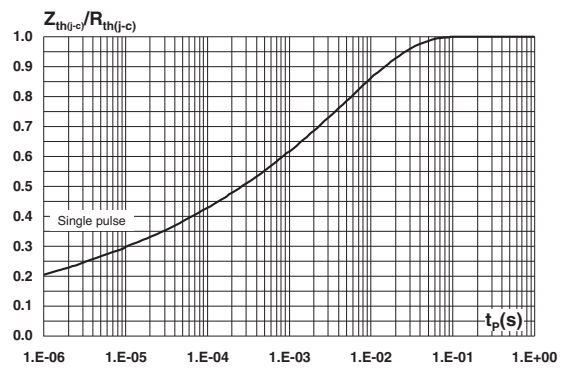
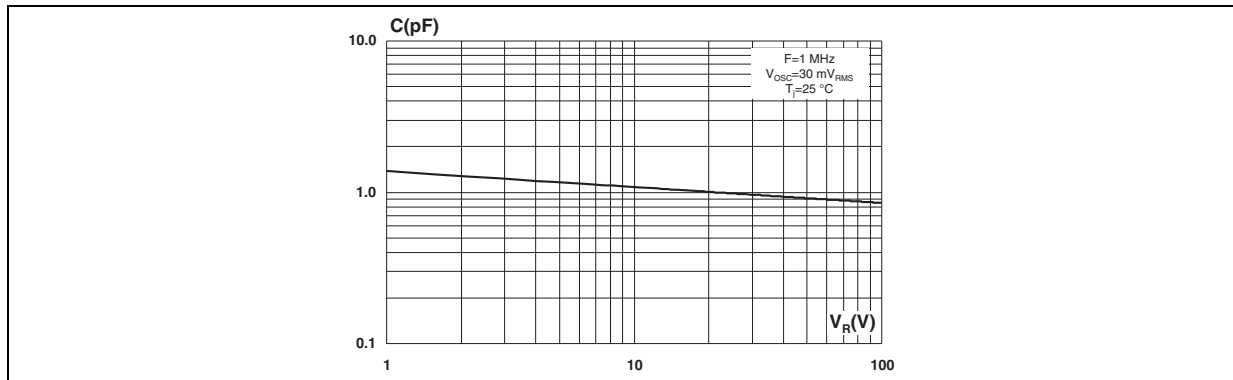

Figure 5. Junction capacitance versus reverse voltage applied (typical values)



2 Package information

In order to meet environmental requirements, ST offers these devices in different grades of ECOPACK® packages, depending on their level of environmental compliance. ECOPACK® specifications, grade definitions and product status are available at: www.st.com. ECOPACK® is an ST trademark.

2.1 Leadless chip carrier 2 (LCC2D) package information

Figure 6. Leadless chip carrier 2 (LCC2D) package outline

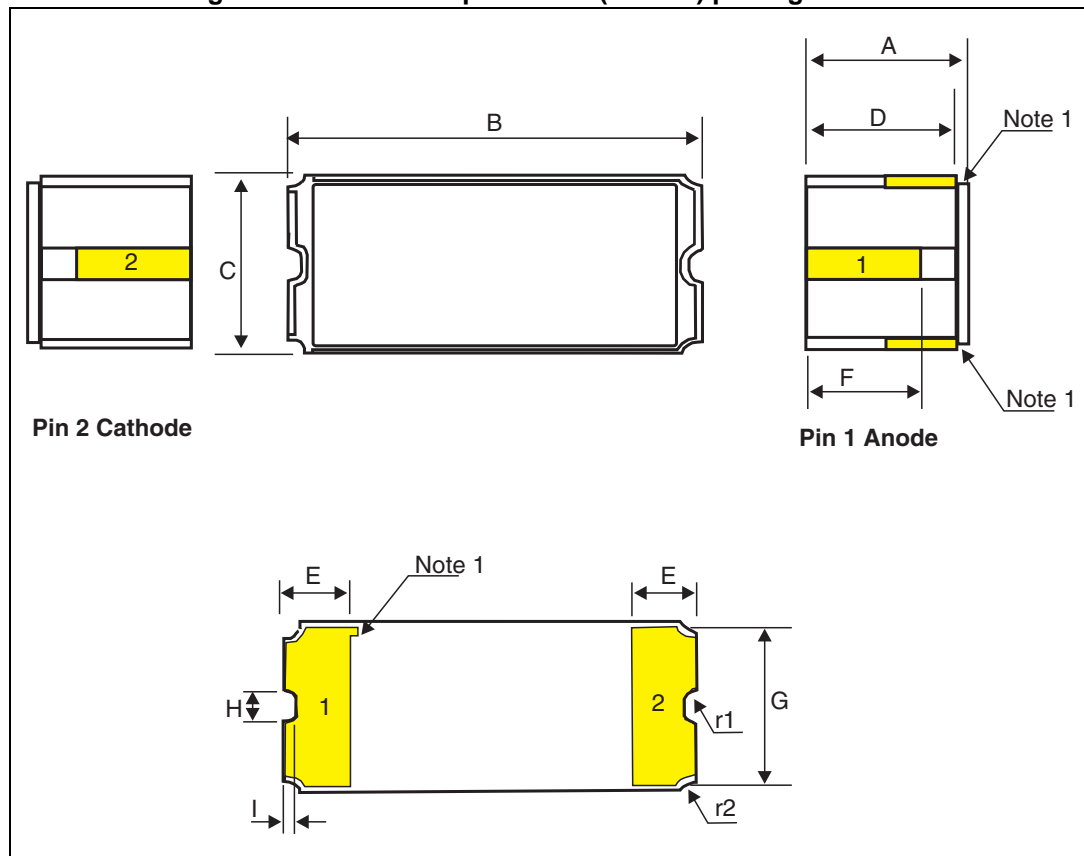

1. The anode is identified by metalization in two top internal angles and the index mark.

Table 6. Leadless chip carrier 2 (LCC2D) package mechanical data

Ref.	Dimensions					
	Millimeters			Inches		
	Min.	Typ.	Max.	Min.	Typ.	Max.
A ⁽¹⁾	1.86	2.03	2.20	0.073	0.080	0.087
B	4.44	4.57	4.77	0.175	0.180	0.188
C	1.84	1.97	2.10	0.072	0.078	0.083
D	1.53	1.70	1.87	0.060	0.067	0.074
E	0.48	-	0.71	0.019	-	0.028
F	-	1.3	-	-	0.051	-
G	-	1.67	-	-	0.066	-
H	-	0.37	-	-	0.015	-
I	-	0.15	-	-	0.006	-
r1	-	0.15	-	-	0.006	-
r2	-	0.20	-	-	0.008	-

1. Measurement prior to solder coating the mounting pads on bottom of package

3 Ordering information

Table 7. Ordering information⁽¹⁾

Order code	ESCC detailed specification	Package	Lead finish	Marking ⁽²⁾	EPPL	Mass	Packing
1N6642UD1	-	LCC2D	Gold	1N6642UD1	-	0.12 g	Waffle pack
1N6642U01D	5101/026/07		Gold	510102607	Y		
1N6642U02D	5101/026/08		Solder dip	510102608	Y		

1. Contact ST sales office for information about the specific conditions for products in die form.

2. Specific marking only. The full marking includes in addition:

For the engineering models: ST logo, date code, country of origin (FR).

For ESCC flight parts: ST logo, date code, country of origin (FR), ESA logo, serial number of the part within the assembly lot.

4 Other information

4.1 Date code

Date code is structured as describe below:

- EM xyywwz
- ESCC flight yywwz

Where:

- x (EM only): 3, assembly location Rennes (France)
- yy: last two digits year
- ww: week digits
- z: lot index in the week

4.2 Documentation

In [Table 8](#) is a summary of the documentation provided with each type of products.

Table 8. Documentation provided with each type of products

Quality level	Documentation
Engineering model	
ESCC flight	Certificate of conformance

5 Revision history

Table 9. Document revision history

Date	Revision	Changes
26-Mar-2010	1	First issue.
23-Sep-2011	2	Updated ESCC status in Features and added footnote to Table 3.
8-Nov-2013	3	Updated Table 1, Table 5 and Table 7 and inserted Other information.
04-Dec-2015	4	Updated Table 7 and reformatted to current standard.

IMPORTANT NOTICE – PLEASE READ CAREFULLY

STMicroelectronics NV and its subsidiaries ("ST") reserve the right to make changes, corrections, enhancements, modifications, and improvements to ST products and/or to this document at any time without notice. Purchasers should obtain the latest relevant information on ST products before placing orders. ST products are sold pursuant to ST's terms and conditions of sale in place at the time of order acknowledgement.

Purchasers are solely responsible for the choice, selection, and use of ST products and ST assumes no liability for application assistance or the design of Purchasers' products.

No license, express or implied, to any intellectual property right is granted by ST herein.

Resale of ST products with provisions different from the information set forth herein shall void any warranty granted by ST for such product.

ST and the ST logo are trademarks of ST. All other product or service names are the property of their respective owners.

Information in this document supersedes and replaces information previously supplied in any prior versions of this document.

© 2015 STMicroelectronics – All rights reserved

