

DATA SHEET

# SKY16602-632LF: Low-Threshold PIN Diode Limiter 0.2 to 4.0 GHz

## Applications

- Cellular infrastructure
- WLAN, WiMAX
- Receiver LNA protection
- Test instruments

## Features

- Optimized for 0.2 to 4.0 GHz operation
- Low limiting threshold (+5 dBm typical)
- Low insertion loss
- Low distortion
- Integrated PIN limiter and Schottky diodes, and DC blocks
- DFN (2-pin, 2.3 x 2.3 mm) Pb-free package, (MSL1, 260°C per JEDEC J-STD-020)



Skyworks Green™ products are compliant with all applicable legislation and are halogen-free. For additional information, refer to *Skyworks Definition of Green™*, document number SQ04-0074.

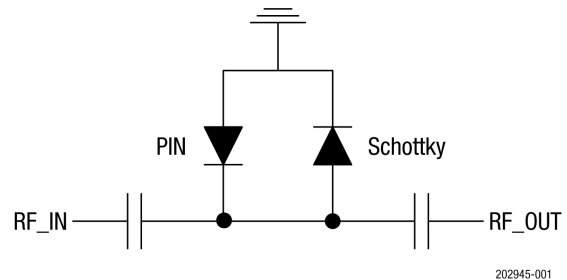


Figure 1. SKY16602-632LF Block Diagram

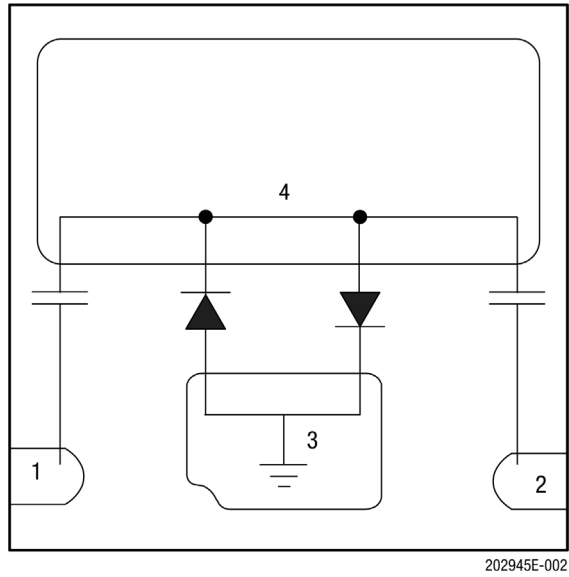
## Description

The SKY16602-632LF is a fully integrated PIN diode low-threshold limiter module in a surface-mount package. It is designed for use as a passive receiver protector in wireless or other RF systems for frequencies up to 4 GHz. It features a low limiting threshold, low-insertion loss, and low distortion in a Dual Flat No Lead (DFN) package.

The SKY16602-632LF module is comprised of a PIN limiter diode, a Schottky diode, and 2 DC blocking caps at the RF ports in a 2-lead DFN. The small package design reduces printed circuit board area. The module can be tuned using external surface mount technology (SMT) components for optimal narrow band performance over the 0.2 to 4.0 GHz operating range.

The module can operate over the temperature range of -40°C to +85°C.

A functional block diagram is shown in Figure 1. The pin configuration and package are shown in Figure 2. Signal pin assignments and functional pin descriptions are provided in Table 1.



**Figure 2. SKY16602-632LF Pinout (Top View)**

**Table 1. SKY16602-632LF Signal Descriptions**

Pin	Name	Description
1	RF_IN	RF input, AC coupled
2	RF_OUT	RF output, AC coupled
3	GND	Must be connected to chassis ground
4	PAD	Exposed pad ( <b>must be isolated from ground</b> )

## Electrical and Mechanical Specifications

The absolute maximum ratings of the SKY16602-632LF are provided in Table 2. Electrical specifications for the un-tuned limiter module are provided in Table 3, and typical performance characteristics are illustrated in Figures 4 and 5. Electrical specifications for the 2.45 GHz tuned limiter module are provided in Table 4, and typical performance characteristics are illustrated in Figures 6 and 7.

Figures 8 and 9 show the power derating curves for the limiter. In Figure 8, the temperature is referenced to the bottom of the DFN package. The power derating curve with the temperature referenced to the bottom of the printed circuit board is shown in Figure 9.

**Table 2. SKY16602-632LF Absolute Maximum Ratings<sup>1</sup>**

Parameter	Symbol	Minimum	Maximum	Unit
RF input power (CW) at T <sub>CASE</sub> = 85°C	P <sub>IN</sub>		12	W
RF input power (1 μs pulse, 10% duty cycle) at T <sub>CASE</sub> = 85°C	P <sub>IN</sub>		120	W
CW power dissipation at T <sub>CASE</sub> = 85°C	P <sub>DIS</sub>		0.4	W
Storage temperature	T <sub>STG</sub>	-65	+150	°C
Operating temperature	T <sub>OP</sub>	-40	+85	°C
Electrostatic discharge:	ESD			
Charged-Device Model (CDM), Class 4			1000	V
Human Body Model (HBM), Class 1B			250	V
Machine Model (MM), Class A			150	V

<sup>1</sup> Exposure to maximum rating conditions for extended periods may reduce device reliability. There is no damage to device with only one parameter set at the limit and all other parameters set at or below their nominal value. Exceeding any of the limits listed here may result in permanent damage to the device.

**ESD HANDLING:** *Although this device is designed to be as robust as possible, electrostatic discharge (ESD) can damage this device. This device must be protected at all times from ESD when handling or transporting. Static charges may easily produce potentials of several kilovolts on the human body or equipment, which can discharge without detection. Industry-standard ESD handling precautions should be used at all times.*

**Table 3. SKY16602-632LF Electrical Specifications (Untuned Circuit, Reference Figure 1)**  
(T<sub>OP</sub> = 25°C, Z<sub>0</sub> = 50 Ω, as Measured in Skyworks Evaluation Board Optimized for Operation at 0.2 to 4.0 GHz, Unless Otherwise Noted)

Parameter	Symbol	Condition	Frequency	Min	Typ	Max	Units
Reverse voltage	V <sub>R</sub>					20	V
Forward current	I <sub>F</sub>					50	mA
Insertion loss	I <sub>L</sub>	P <sub>IN</sub> = 0 dBm	0.90 GHz		0.3	0.5	dB
Return loss	R <sub>L</sub>	P <sub>IN</sub> = 0 dBm	0.90 GHz		14		dB
Threshold level	T <sub>L</sub>	P <sub>1dB</sub>	0.90 GHz	5.3	6.0	6.7	dBm
Saturated CW input power <sup>1</sup>	P <sub>IN_CW</sub>		0.90 GHz		30		dBm
Flat leakage power <sup>2</sup>	F <sub>L</sub>	P <sub>IN</sub> = +10 dBm	0.90 GHz		6		dBm
Recovery time <sup>3</sup>	t <sub>R</sub>		0.90 GHz		5		ns
Thermal resistance	θ <sub>JC</sub>	Junction-to-case			114		°C/W

<sup>1</sup> Saturated CW input power is defined as the point where the diode series resistance does not change with the rectified current. As the input power increases past this point, output power will increase until the diode reaches its max power limit.

<sup>2</sup> Flat leakage power is defined as the power level after the limiter has fully turned on and the output pulse reaches a constant level.

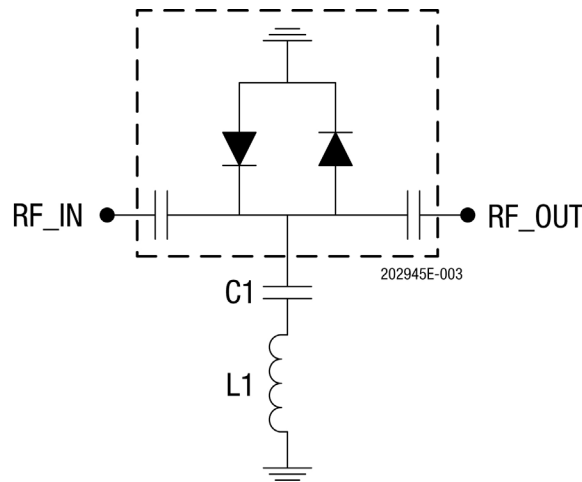
<sup>3</sup> Recovery time represents the transition time from the high-loss to low-loss state following the removal of high-power input. RF pulse modulation: 1 μs pulse width and 0.1% duty factor.

**Theory of Operation**

A limiter prevents overload by allowing RF signals that are below a certain threshold to pass through, but larger signals exceeding the threshold are increasingly attenuated. The SKY16602-632LF has a lower threshold level over a traditional self-bias limiter circuit with an inductor for a ground return. It accomplishes this by adding a basic PIN limiter diode (pin 1) in parallel to a Schottky diode (pin 2). The low turn on voltage of the Schottky diode reduces the threshold level while the PIN limiter diode protects the Schottky diode at higher power levels. Therefore, for maximum RF power handling, the RF input signal is required to be connected to Pin 1. The two internal DC input/output capacitors provide DC blocking needed for most applications.

**Tuned Circuit**

The module may be RF tuned for optional RF match and insertion loss centered at a target frequency within its normal band of operation. This is done with the use of external surface mount components. The schematic diagram in Figure 3 shows the SKY16602-632LF limiter with a shunt connected capacitor and inductor tuned for 2.45 GHz. The Bill of Materials for the 2.45 GHz tuned circuit is shown in Table 4. Electrical specifications for the 2.45 GHz tuned limiter module are provided in Table 5.



**Figure 3. SKY16602-632LF Schematic with External Tuning Networks Optimized for 2.45 GHz**

**Table 4. Evaluation Board Bill of Materials for EN33-D946-001 (2.45 GHz Tuned Circuit)**

Component	Value	Size	Manufacturer	Mfr. Part Number	Characteristics
C1	15 pF	0402	Murata	GRM1555C1H150J	COG, 50 V
L1	2.2 nH	0402	Taiyo Uden	HK10052N2S	300 mA, R = 0.13 $\Omega$

**Table 5. SKY16602-632LF Electrical Specifications (Tuned to 2.45 GHz Operation, Reference Figure 3)  
(Top = 25°C, Zo = 50  $\Omega$ , as Measured in Skyworks Evaluation Board Optimized for Operation at 2.45 GHz, Unless Otherwise Noted)**

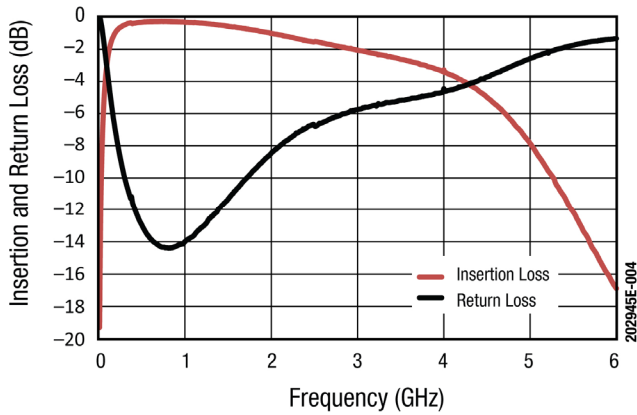
Parameter	Symbol	Condition	Frequency	Min	Typ	Max	Units
Insertion loss	IL	P <sub>IN</sub> = 0 dBm	2.45 GHz		0.5		dB
Return loss	R <sub>L</sub>	P <sub>IN</sub> = 0 dBm	2.45 GHz		25		dB
Threshold level	T <sub>L</sub>	P1dB	2.45 GHz		5		dBm
Saturated CW input power <sup>1</sup>	P <sub>IN_CW</sub>		2.45 GHz		23		dBm
Flat leakage power <sup>2</sup>	F <sub>L</sub>	P <sub>IN</sub> = +10 dBm	2.45 GHz		4		dBm
Input third order intercept	IIP3	P <sub>IN</sub> = -10 dBm/tone, spacing = 10 MHz	2.45 GHz		21		dBm
Recovery time <sup>3</sup>	t <sub>R</sub>		2.45 GHz		5		ns
Thermal resistance	$\theta_{JC}$	Junction to case			114		°C/W

<sup>1</sup> Saturated CW input power is defined as the point where the diode series resistance does not change with the rectified current. As the input power increases past this point, output power will increase until the diode reaches its max power limit.

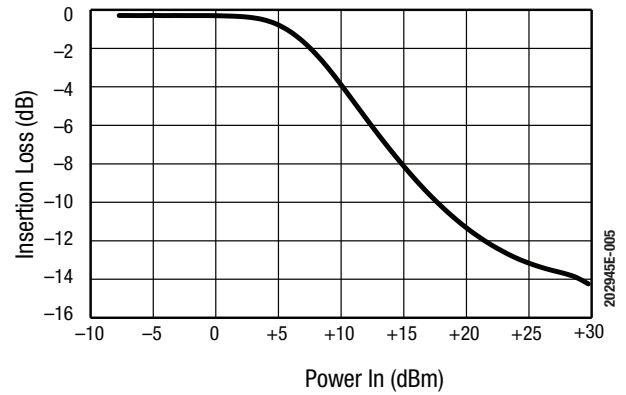
<sup>2</sup> Flat leakage power is defined as the power level after the limiter has fully turned on and the output pulse reaches a constant level.

<sup>3</sup> Recovery time represents the transition time from the high-loss to low-loss state following the removal of high-power input. RF pulse modulation: 1  $\mu$ s pulse width and 0.1% duty factor.

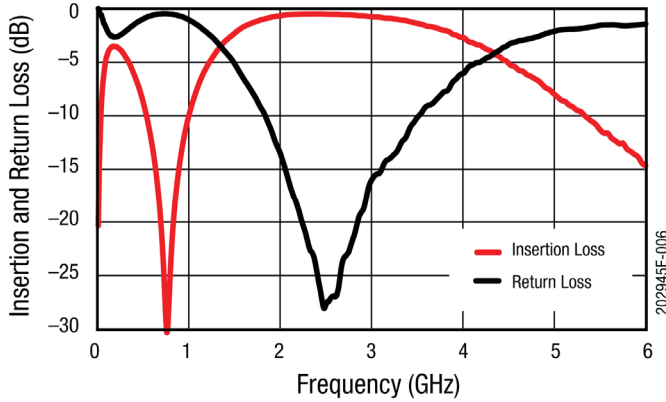
**Typical Performance Characteristics**  
 (TOP=25 °C, Characteristic Impedance = 50 Ω)



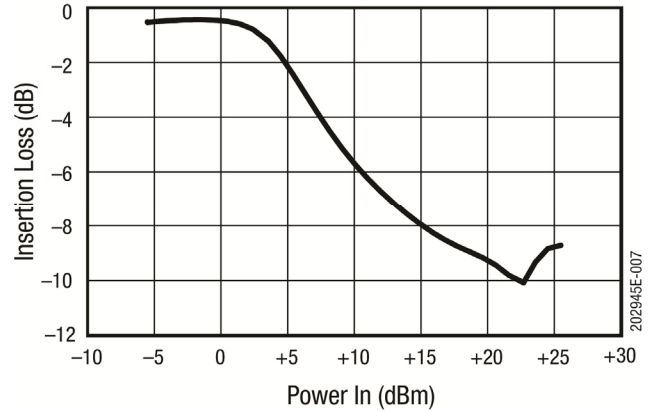
**Figure 4. Small Signal Performance without External Tuning**



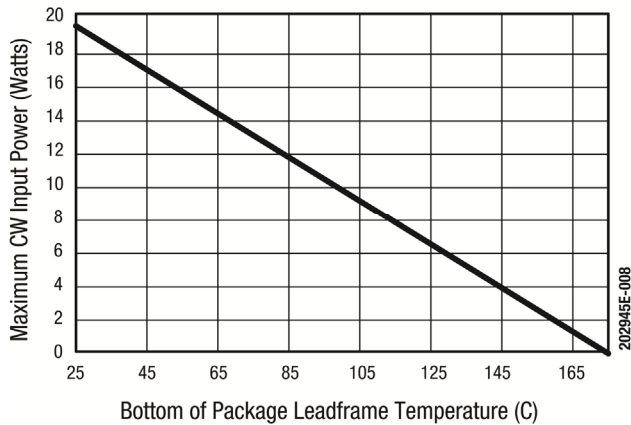
**Figure 5. Insertion Loss vs CW Input Power at 0.90 GHz without External Tuning**



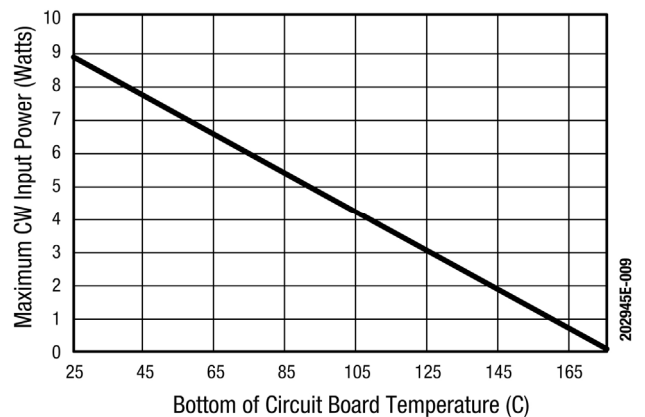
**Figure 6. Small Signal Performance with External Tuning Networks Optimized for 2.45 GHz**



**Figure 7. Insertion Loss vs CW Input Power at 2.45 GHz (Tuned Circuit)**



**Figure 8. Power Derating Curve (Insertion Loss = 0.3 dB) vs Temperature on Bottom of Package Leadframe**



**Figure 9. Power Derating Curve (Insertion Loss = 0.3 dB) vs Temperature on Bottom of EVB Circuit Board**

### Evaluation Board Description

The SKY16602-632LF Evaluation Boards are used to test the performance of the limiter. Assembly drawings for the Evaluation Boards are shown in Figures 10 and 11. The Evaluation Board layer detail is provided in Figure 12.

### Package Dimensions

The PCB layout footprint for the SKY16602-632LF is shown in Figure 13. Typical part markings are noted in Figure 14. Package dimensions are shown in Figure 15, and tape and reel dimensions are provided in Figure 16.

### Package and Handling Information

Instructions on the shipping container label regarding exposure to moisture after the container seal is broken must be followed. Otherwise, problems related to moisture absorption may occur when the part is subjected to high temperature during solder assembly.

The SKY16602-632LF is rated to Moisture Sensitivity Level 1 (MSL1) at 260 °C. It can be used for lead or lead-free soldering. For additional information, refer to the Skyworks Application Note, Solder Reflow Information, document number 200164.

Care must be taken when attaching this product, whether it is done manually or in a production solder reflow environment. Production quantities of this product are shipped in a standard tape and reel format.

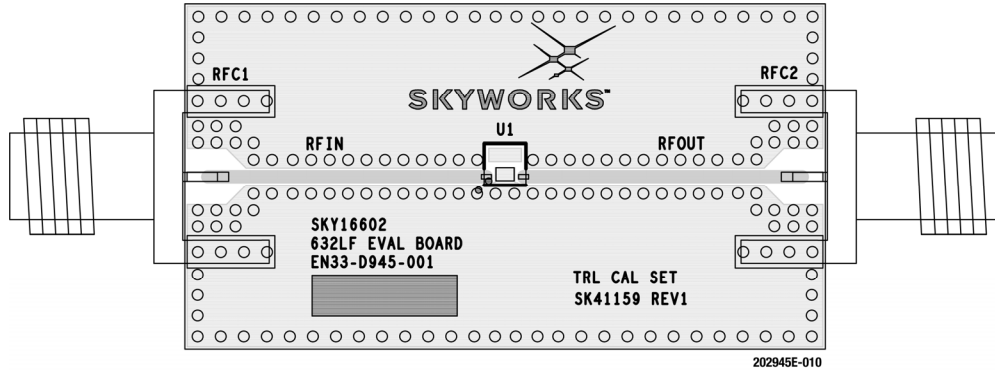


Figure 10. SKY16602-632LF Evaluation Board Assembly Diagram

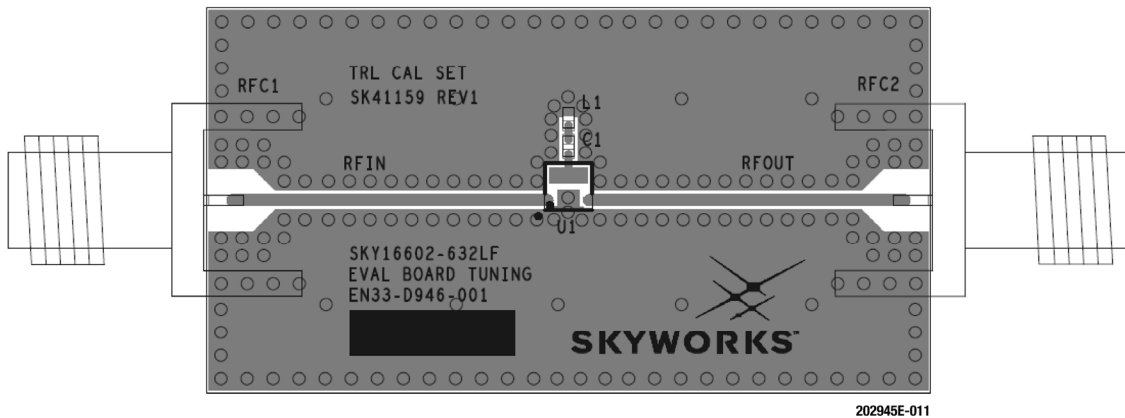
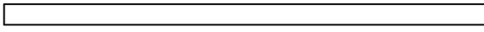
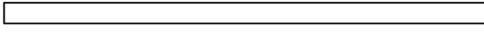

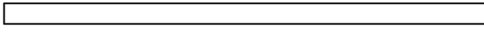

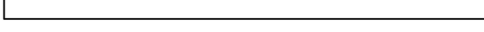





Figure 11. SKY16602-632LF Evaluation Board Assembly Diagram (Tuned Circuit)

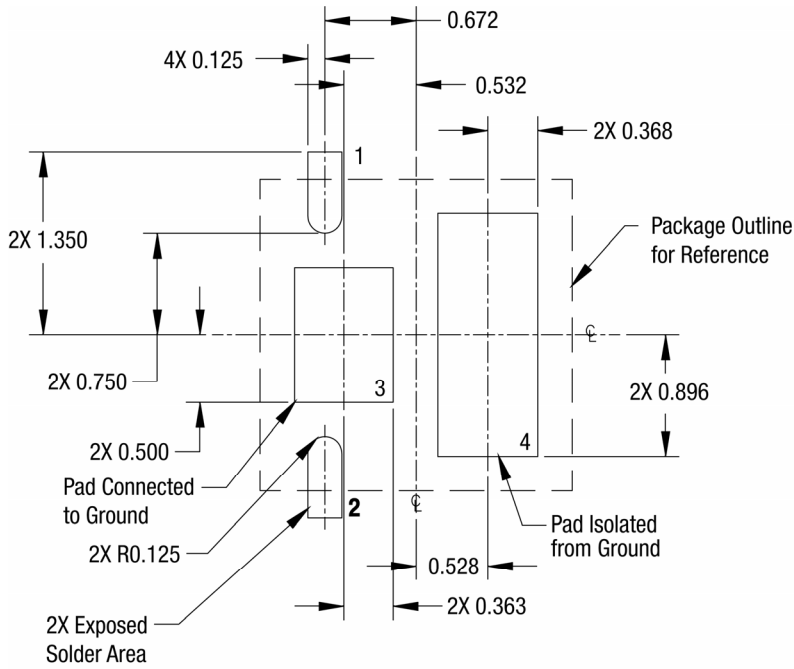
Cross Section	Name	Thickness (in)	Material
	Top Solder mask		
	L1	(0.0028)	Cu foil
	Laminate	0.012 ± 0.0006	Rogers R04003C Core
	L2	(0.0014)	Cu foil
	Laminate	(Note 1)	FR4 Prepreg
	L3	(0.0014)	Cu foil
	Laminate	0.010 ± 0.0006	FR4 Core
	L4	(0.0028)	Cu foil
	Bottom Solder mask		

Note 1: Adjust this thickness to meet total thickness goal of 0.062 ± 0.005 inches.

202945E-012

**Figure 12. Board Layer Detail Physical Characteristics**

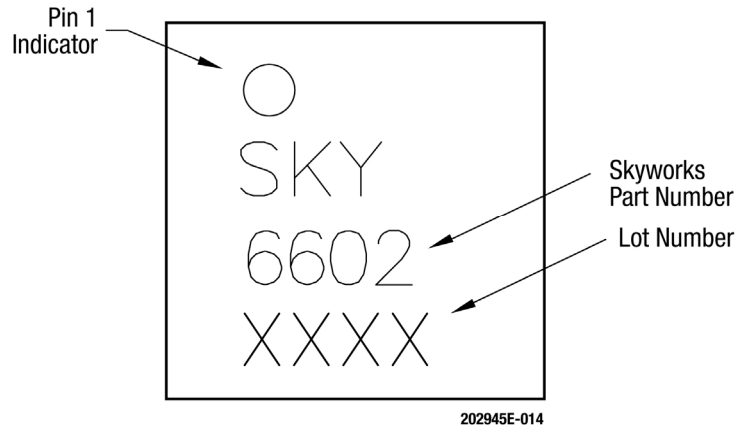




All dimensions are in millimeters

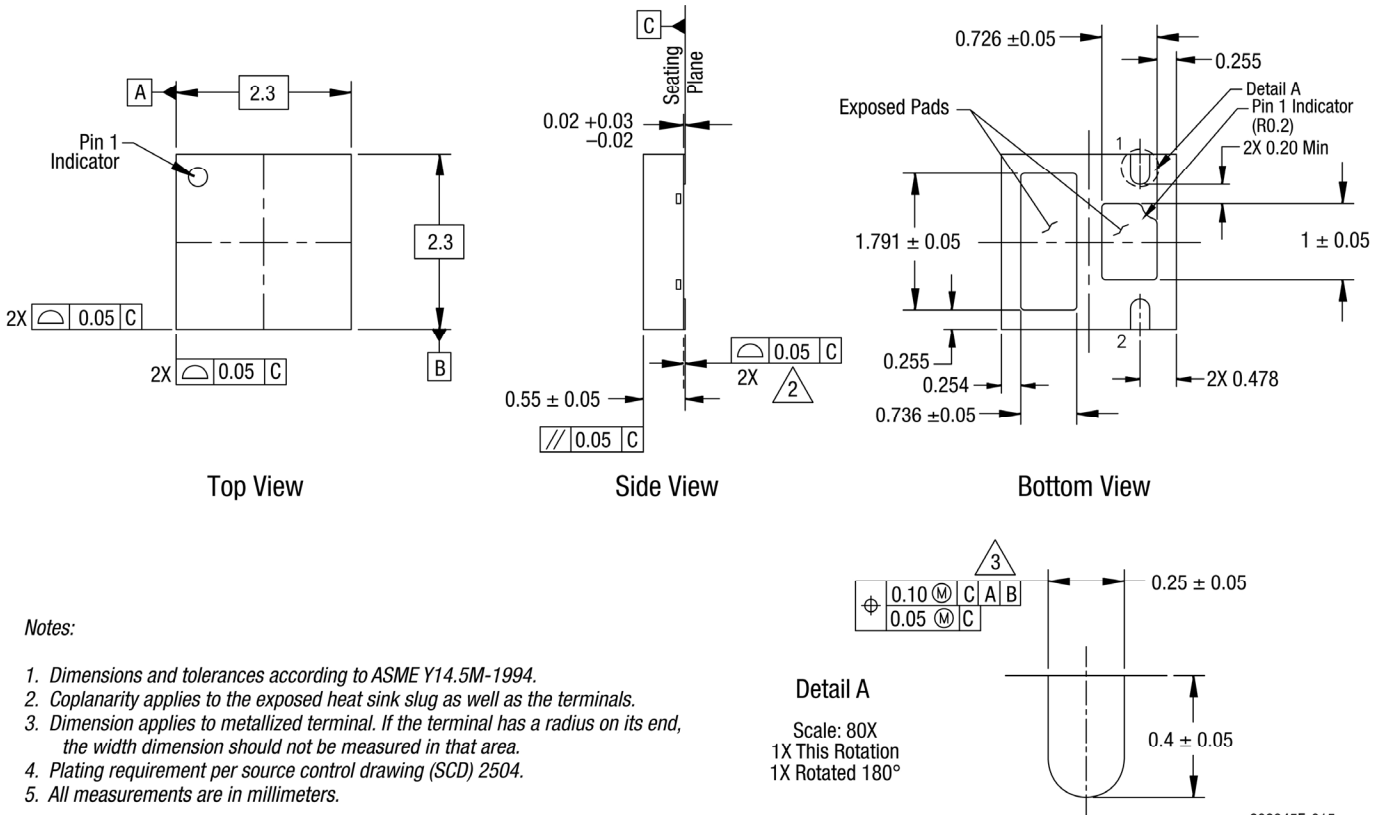
202945E-013

**Figure 13. SKY16602-632LF PCB Layout Footprint**

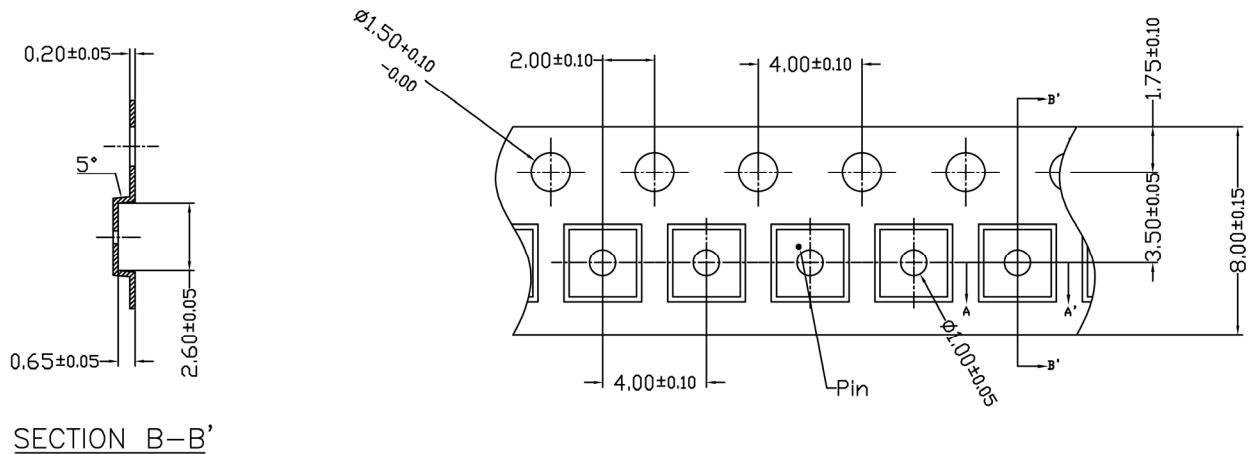


**Figure 14. SKY16602-632LF Typical Part Markings**

**DATA SHEET • SKY16602-632LF: LOW-THRESHOLD PIN DIODE LIMITER**

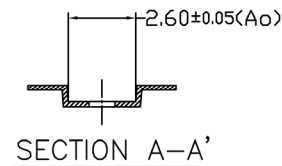


**Figure 15. SKY16602-632LF Package Dimensions**



**SECTION B-B'**

1. CARRIER TAPE MUST MEET ALL SKYWORKS REQUIREMENTS OF GP01-D233 PROCUREMENT SPEC FOR TAPE AND REEL
2. CARRIER TAPE SHALL BE BLACK CONDUCTIVE POLYCARBONATE NON BAKEABLE.
3. COVER TAPE SHALL BE TRANSPARENT CONDUCTIVE MATERIAL
4. ESD-SURFACE RESISTIVITY SHALL MEET GP01-D233
5. 10 SPROCKET HOLE PITCH CUMULATIVE TOLERANCE : ±0.20mm
6. Ao & Bo MEASURED ON PLANE 0.30mm ABOVE THE BOTTOM OF THE POCKET.
7. ALL DIMENSIONS ARE IN MILLIMETERS.



**Figure 16. SKY16602-632LF Tape and Reel Dimensions**

## Ordering Information

Part Number	Product Description	Evaluation Board Part Number
SKY16602-632LF	Low-Threshold PIN Diode Limiter	SKY16602-632LF-EVB

Copyright © 2013-2014, 2016, 2019 Skyworks Solutions, Inc. All Rights Reserved.

Information in this document is provided in connection with Skyworks Solutions, Inc. ("Skyworks") products or services. These materials, including the information contained herein, are provided by Skyworks as a service to its customers and may be used for informational purposes only by the customer. Skyworks assumes no responsibility for errors or omissions in these materials or the information contained herein. Skyworks may change its documentation, products, services, specifications or product descriptions at any time, without notice. Skyworks makes no commitment to update the materials or information and shall have no responsibility whatsoever for conflicts, incompatibilities, or other difficulties arising from any future changes.

No license, whether express, implied, by estoppel or otherwise, is granted to any intellectual property rights by this document. Skyworks assumes no liability for any materials, products or information provided hereunder, including the sale, distribution, reproduction or use of Skyworks products, information or materials, except as may be provided in Skyworks Terms and Conditions of Sale.

THE MATERIALS, PRODUCTS AND INFORMATION ARE PROVIDED "AS IS" WITHOUT WARRANTY OF ANY KIND, WHETHER EXPRESS, IMPLIED, STATUTORY, OR OTHERWISE, INCLUDING FITNESS FOR A PARTICULAR PURPOSE OR USE, MERCHANTABILITY, PERFORMANCE, QUALITY OR NON-INFRINGEMENT OF ANY INTELLECTUAL PROPERTY RIGHT; ALL SUCH WARRANTIES ARE HEREBY EXPRESSLY DISCLAIMED. SKYWORKS DOES NOT WARRANT THE ACCURACY OR COMPLETENESS OF THE INFORMATION, TEXT, GRAPHICS OR OTHER ITEMS CONTAINED WITHIN THESE MATERIALS. SKYWORKS SHALL NOT BE LIABLE FOR ANY DAMAGES, INCLUDING BUT NOT LIMITED TO ANY SPECIAL, INDIRECT, INCIDENTAL, STATUTORY, OR CONSEQUENTIAL DAMAGES, INCLUDING WITHOUT LIMITATION, LOST REVENUES OR LOST PROFITS THAT MAY RESULT FROM THE USE OF THE MATERIALS OR INFORMATION, WHETHER OR NOT THE RECIPIENT OF MATERIALS HAS BEEN ADVISED OF THE POSSIBILITY OF SUCH DAMAGE.

Skyworks products are not intended for use in medical, lifesaving or life-sustaining applications, or other equipment in which the failure of the Skyworks products could lead to personal injury, death, physical or environmental damage. Skyworks customers using or selling Skyworks products for use in such applications do so at their own risk and agree to fully indemnify Skyworks for any damages resulting from such improper use or sale.

Customers are responsible for their products and applications using Skyworks products, which may deviate from published specifications as a result of design defects, errors, or operation of products outside of published parameters or design specifications. Customers should include design and operating safeguards to minimize these and other risks. Skyworks assumes no liability for applications assistance, customer product design, or damage to any equipment resulting from the use of Skyworks products outside of stated published specifications or parameters.

Skyworks and the Skyworks symbol are trademarks or registered trademarks of Skyworks Solutions, Inc. or its subsidiaries in the United States and other countries. Third-party brands and names are for identification purposes only, and are the property of their respective owners. Additional information, including relevant terms and conditions, posted at [www.skyworksinc.com](http://www.skyworksinc.com), are incorporated by reference.