



UM18-21112A211

UM18

ULTRASONIC SENSORS

SICK
Sensor Intelligence.



Ordering information

Type	Part no.
UM18-21112A211	6048390

Other models and accessories → www.sick.com/UM18



Detailed technical data

Mechanics/electronics

Supply voltage V_s	DC 10 V ... 30 V ¹⁾
Power consumption	$\leq 1.2 \text{ W}$ ²⁾
Initialization time	< 300 ms
Design	Cylindrical
Housing material	Nickel-plated brass Ultrasonic transducer: polyurethane foam, glass epoxy resin
Connection type	Male connector, M12, 5-pin
Indication	2 x LED
Weight	25 g
Sending axis	Straight
Enclosure rating	IP65 / IP67
Protection class	III

¹⁾ Limit values, reverse-polarity protected Operation in short-circuit protected network: max. 8 A, class 2.

²⁾ Without load.

Performance

Operating range, limiting range	30 mm ... 250 mm, 350 mm
Target	Natural objects
Resolution	$\geq 0.069 \text{ mm}$
Repeatability	$\pm 0.15 \%$ ¹⁾
Accuracy	$\pm 1 \%$ ^{1) 2)}
Temperature compensation	✓
Response time	32 ms

¹⁾ Referring to current measurement value.

²⁾ Temperature compensation can be switched off, without temperature compensation: 0.17 % / K.

Switching frequency	25 Hz
Output time	8 ms
Ultrasonic frequency (typical)	320 kHz
Additional function	Set switching mode: Distance to object (DtO) / Window (Wnd) / Object between sensor and background (ObSB), teach-in of digital output, invertible digital output, multifunctional input: external teach / synchronization / multiplexing, synchronization of up to 20 sensors, multiplexing: no cross talk of up to 20 sensors, reset to factory default

¹⁾ Referring to current measurement value.

²⁾ Temperature compensation can be switched off, without temperature compensation: 0.17 % / K.

Interfaces

IO-Link	✓, V1.0
Function	Process data, parameterization, diagnosis
Digital output	
Number	1 ¹⁾
Type	Push-pull: PNP/NPN
Maximum output current I_A	≤ 100 mA
Multifunctional input (MF)	1 x MF
Hysteresis	3 mm

¹⁾ Push-pull: PNP/NPN HIGH = $U_V - (< 3 V)$ / LOW < 3 V.

Ambient data

Ambient temperature operation	-25 °C ... +70 °C
Ambient storage temperature	-40 °C ... +85 °C

Classifications

ECl@ss 5.0	27270804
ECl@ss 5.1.4	27270804
ECl@ss 6.0	27270804
ECl@ss 6.2	27270804
ECl@ss 7.0	27270804
ECl@ss 8.0	27270804
ECl@ss 8.1	27270804
ECl@ss 9.0	27270804
ECl@ss 10.0	27270804
ECl@ss 11.0	27270804
ETIM 5.0	EC001846
ETIM 6.0	EC001846
ETIM 7.0	EC001846
UNSPSC 16.0901	41111960

Dimensional drawing (Dimensions in mm (inch))

UM18-2xxxxx1

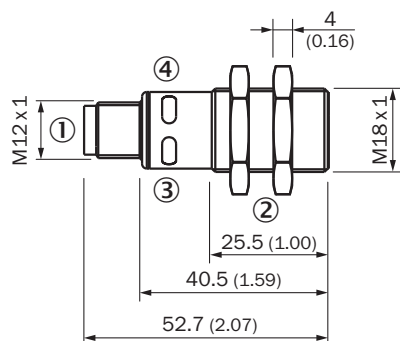

- ① Connection
- ② Mounting nuts, SW 24 mm
- ③ Status display for supply voltage active (green)
- ④ Status indicator switching/analog output (orange)

Connection type

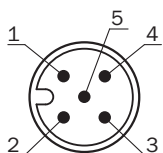

Connection diagram

UM18-21xxxAxxx Connector M12, 5-pin

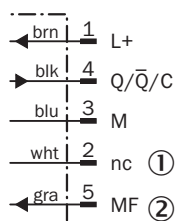

- ① Not assigned
- ② Multifunctional input/synchronization and multiplex operation/communication Connect+

Detection area



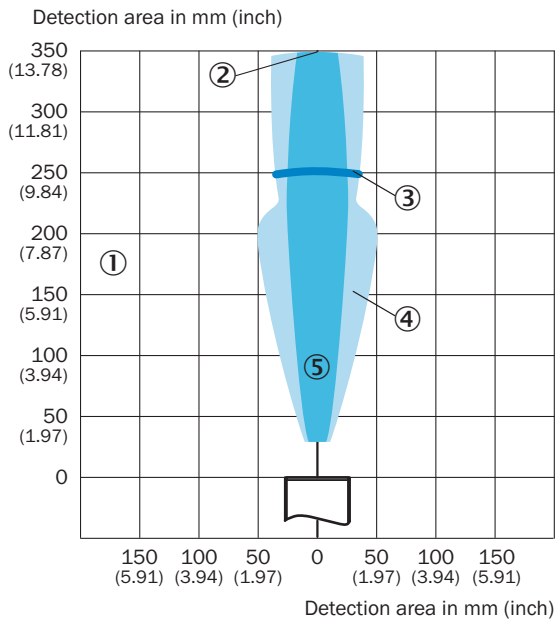

UM18-211



- ① Detection range dependent on reflection properties, size, and alignment of the object
- ② Limiting range
- ③ Operating range
- ④ Example object: aligned plate 500 mm x 500 mm
- ⑤ Example object: cylindrical bar with a diameter of 10 mm

Recommended accessories

Other models and accessories → www.sick.com/UM18

	Brief description	Type	Part no.
Mounting brackets and plates			
	Mounting plate for M18 sensors, steel, zinc coated, without mounting hardware	BEF-WG-M18	5321870
Modules and gateways			
	IO-Link V1.1 Class A port, USB2.0 port, optional external power supply 24V / 1A	IOLA2US-01101 (SiLink2 Master)	1061790
Plug connectors and cables			
	Head A: female connector, M12, 5-pin, straight, A-coded Head B: Flying leads Cable: Sensor/actuator cable, PVC, unshielded, 2 m	YF2A15- 020VB5XLEAX	2096239
Deflector mirrors			
	90° sound deflection plate for UM18-1xxxx and UM18-2xxxx, stainless steel, for straight versions	USP-UM18	5323658

Recommended services

Additional services → www.sick.com/UM18

	Type	Part no.
Warranty extensions		
<ul style="list-style-type: none">• Product area: Identification solutions, machine vision, Distance sensors, Detection and ranging solutions• Range of services: The services correspond to the scope of the statutory manufacturer warranty (SICK general terms and conditions of purchase)• Duration: Five-year warranty from date of purchase.	Five-year extended warranty	1680671

SICK AT A GLANCE

SICK is one of the leading manufacturers of intelligent sensors and sensor solutions for industrial applications. A unique range of products and services creates the perfect basis for controlling processes securely and efficiently, protecting individuals from accidents and preventing damage to the environment.

We have extensive experience in a wide range of industries and understand their processes and requirements. With intelligent sensors, we can deliver exactly what our customers need. In application centers in Europe, Asia and North America, system solutions are tested and optimized in accordance with customer specifications. All this makes us a reliable supplier and development partner.

Comprehensive services complete our offering: SICK LifeTime Services provide support throughout the machine life cycle and ensure safety and productivity.

For us, that is “Sensor Intelligence.”

WORLDWIDE PRESENCE:

Contacts and other locations –www.sick.com