



# KT5W-2P1113

KT5

CONTRAST SENSORS

**SICK**  
Sensor Intelligence.



### Ordering information

| Type        | Part no. |
|-------------|----------|
| KT5W-2P1113 | 1016629  |

Other models and accessories → [www.sick.com/KT5](http://www.sick.com/KT5)



### Detailed technical data

#### Features

|  |  |
|--|--|
| <b>Dimensions (W x H x D)</b>          | 30.4 mm x 53 mm x 80 mm                      |
| <b>Sensing distance</b>                | 10 mm <sup>1)</sup>                          |
| <b>Housing design (light emission)</b> | Rectangular                                  |
| <b>Light source</b>                    | LED, RGB <sup>2)</sup>                       |
| <b>Wave length</b>                     | 470 nm, 525 nm, 640 nm                       |
| <b>Light emission</b>                  | Long and short side of housing, exchangeable |
| <b>Light spot size</b>                 | 1.2 mm x 4.2 mm                              |
| <b>Light spot direction</b>            | Vertical <sup>3)</sup>                       |
| <b>Adjustment</b>                      | Teach-in button                              |
| <b>Teach-in mode</b>                   | Teach-in dynamic                             |

<sup>1)</sup> From front edge of lens.

<sup>2)</sup> Average service life: 100,000 h at T<sub>J</sub> = +25 °C.

<sup>3)</sup> In relation to long side of housing.

#### Mechanics/electronics

|                            |                                   |
|----------------------------|-----------------------------------|
| <b>Supply voltage</b>      | 10 V DC ... 30 V DC <sup>1)</sup> |
| <b>Ripple</b>              | ≤ 5 V <sub>pp</sub> <sup>2)</sup> |
| <b>Power consumption</b>   | < 80 mA <sup>3)</sup>             |
| <b>Switching frequency</b> | 10 kHz <sup>4)</sup>              |
| <b>Response time</b>       | 50 μs <sup>5)</sup>               |

<sup>1)</sup> Limit values when operated in short-circuit protected network: max. 8 A.

<sup>2)</sup> May not exceed or fall below U<sub>v</sub> tolerances.

<sup>3)</sup> Without load.

<sup>4)</sup> With light/dark ratio 1:1.

<sup>5)</sup> Signal transit time with resistive load.

<sup>6)</sup> Short-circuit-proof.

<sup>7)</sup> Reference voltage DC 50 V.

|   |   |
|---|---|
| <b>Switching output</b>                     | PNP   |
| <b>Switching output (voltage)</b>           | PNP: HIGH = $V_S - \leq 2 \text{ V}$ / LOW approx. 0 V  |
| <b>Output current <math>I_{\max}</math></b> | 100 mA <sup>6)</sup>  |
| <b>Input, teach-in (ET)</b>                 | PNP<br>Teach: $U = 10 \text{ V} \dots < U_V$<br>Run: $U < 2 \text{ V}$  |
| <b>Input, light/dark (L/D)</b>              | PNP<br>Light: $U = 0 \text{ V}$<br>Dark: $U > 10 \text{ V} \dots < U_V$   |
| <b>Retention time (ET)</b>                  | 25 ms, non-volatile memory  |
| <b>Connection type</b>                      | Male connector M12, 5-pin   |
| <b>Protection class</b>                     | II <sup>7)</sup>  |
| <b>Circuit protection</b>                   | $U_V$ connections, reverse polarity protected<br>Output Q short-circuit protected<br>Interference pulse suppression |
| <b>Enclosure rating</b>                     | IP67  |
| <b>Weight</b>                               | 400 g   |
| <b>Housing material</b>                     | Metal, Zinc diecast   |

<sup>1)</sup> Limit values when operated in short-circuit protected network: max. 8 A.

<sup>2)</sup> May not exceed or fall below  $U_V$  tolerances.

<sup>3)</sup> Without load.

<sup>4)</sup> With light/dark ratio 1:1.

<sup>5)</sup> Signal transit time with resistive load.

<sup>6)</sup> Short-circuit-proof.

<sup>7)</sup> Reference voltage DC 50 V.

## Ambient data

|                                      |                              |
|--------------------------------------|------------------------------|
| <b>Ambient operating temperature</b> | -10 °C ... +55 °C            |
| <b>Ambient storage temperature</b>   | -25 °C ... +75 °C            |
| <b>Shock load</b>                    | According to IEC 60068       |
| <b>UL File No.</b>                   | NRKH.E181493 & NRKH7.E181493 |

## Classifications

|                       |          |
|-----------------------|----------|
| <b>ECl@ss 5.0</b>     | 27270906 |
| <b>ECl@ss 5.1.4</b>   | 27270906 |
| <b>ECl@ss 6.0</b>     | 27270906 |
| <b>ECl@ss 6.2</b>     | 27270906 |
| <b>ECl@ss 7.0</b>     | 27270906 |
| <b>ECl@ss 8.0</b>     | 27270906 |
| <b>ECl@ss 8.1</b>     | 27270906 |
| <b>ECl@ss 9.0</b>     | 27270906 |
| <b>ETIM 5.0</b>       | EC001820 |
| <b>ETIM 6.0</b>       | EC001820 |
| <b>UNSPSC 16.0901</b> | 39121528 |

### Dimensional drawing (Dimensions in mm (inch))

KT5-2 Teach-in, KT5-2 Display

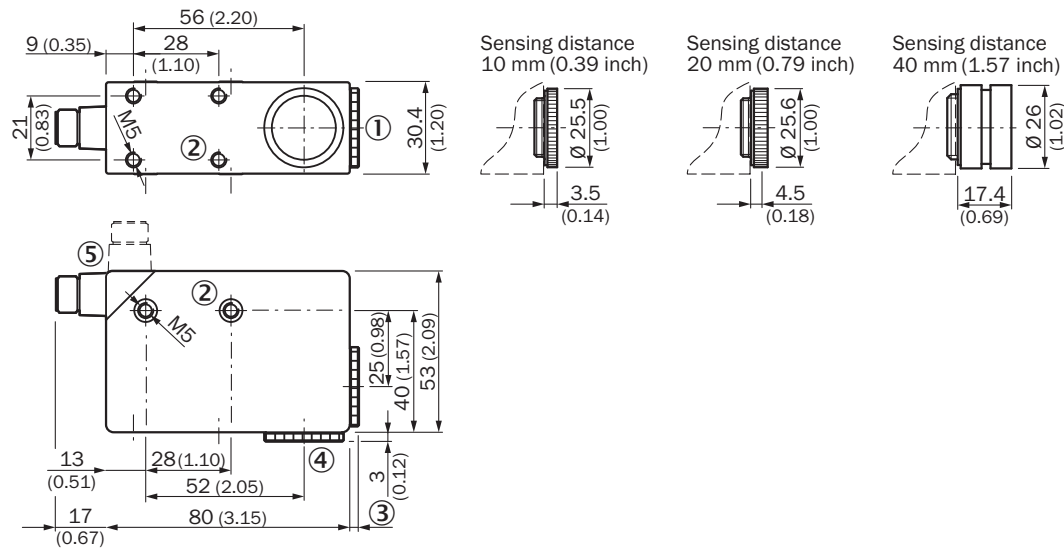

- ① Lens (light transmission), can be exchanged for pos. 4
- ② M5 threaded mounting hole, 5.5 mm deep
- ③ See dimensional drawings of lenses
- ④ Blind screw can be replaced by pos. 1
- ⑤ Connector M12 (rotatable up to 90°)

### Adjustments

KT5-2 Teach-in, KT5W-xxx3

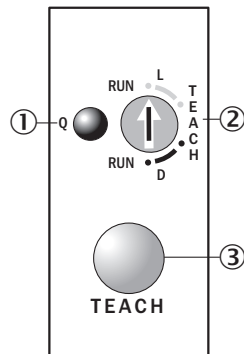

- ① Function signal indicator (yellow)
- ② Pre-selection switch
- ③ Teach-in button

## Connection diagram

Cd-324

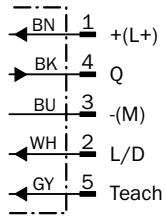

## Concept of operation

KT5-2 Teach-in, teach-in dynamic

### 1. Select switching function (light/dark)

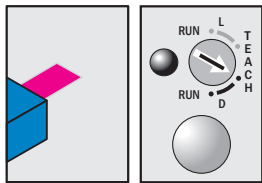

Turn rotary switch to desired teach position:  
 D = dark switching  
 L = light switching

### 2. Position mark or background

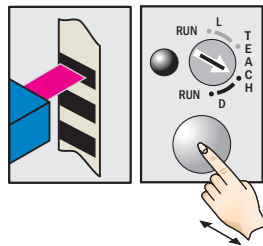

Press the teach-in button and keep it pressed.

### 3. Move at least one repeat length using the light spot

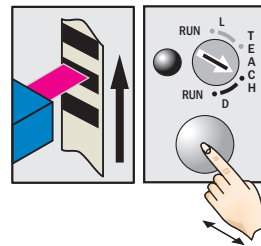

Keep the teach-in button pressed.

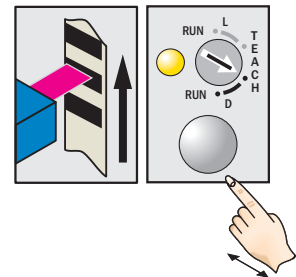

Release the teach-in button. Yellow LED will illuminate, when emitted light is on the mark.

## Example

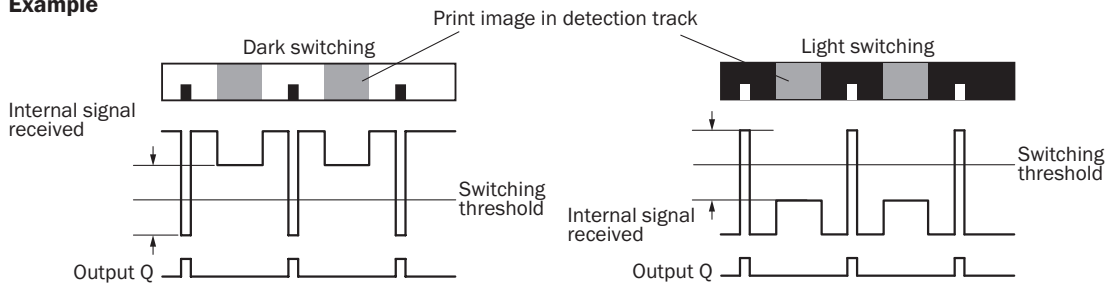

## Switching characteristics

The optimum emitted light is selected automatically.

The switching threshold is set in the center between the lowest and the second-lowest reflectivity.

Teach-in can also be performed using an external control signal.

Light/dark setting can also be configured using an external control signal.

Observe the minimum speed (25 mm/s ... 300 mm/s).

### Sensing distance



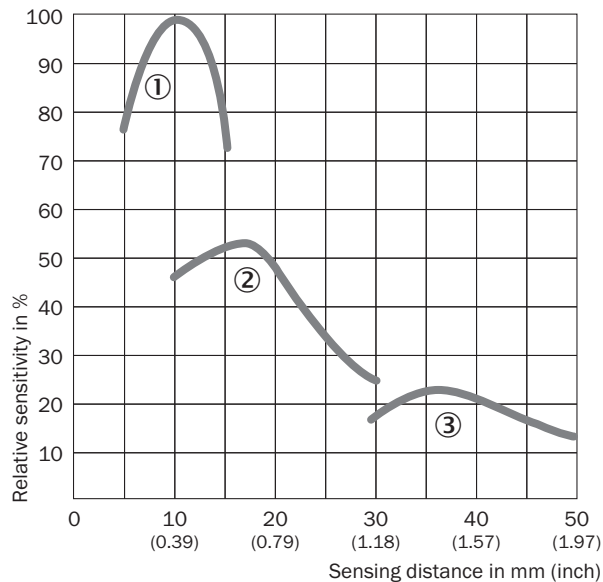

Sensing distance







- ① Sensing distance 10 mm
- ② Sensing distance 20 mm
- ③ Sensing distance 40 mm

### Recommended accessories

Other models and accessories → [www.sick.com/KT5](http://www.sick.com/KT5)

|   | Brief description   | Type        | Part no. |
|---|---|-------------|----------|
| <b>Universal bar clamp systems</b>  |   |             |          |
|  | Plate G for universal clamp bracket, steel, zinc coated, Universal clamp (2022726), mounting hardware | BEF-KHS-G01 | 2022464  |
|  | Plate K for universal clamp bracket, steel, zinc coated, Universal clamp (2022726), mounting hardware | BEF-KHS-K01 | 2022718  |
|  | Universal clamp bracket for rod mounting, steel, zinc coated, without mounting hardware               | BEF-KHS-KH1 | 2022726  |
|  | Mounting bar, straight, 200 mm, steel, steel, zinc coated, without mounting hardware                  | BEF-MS12G-A | 4056054  |
|   | Mounting bar, straight, 300 mm, steel, steel, zinc coated, without mounting hardware                  | BEF-MS12G-B | 4056055  |
|  | Mounting bar, L-shaped, 150 mm x 150 mm, steel, steel, zinc coated, without mounting hardware         | BEF-MS12L-A | 4056052  |
|   | Mounting bar, L-shaped, 250 x 250 mm, steel, steel, zinc coated, without mounting hardware            | BEF-MS12L-B | 4056053  |

|   | Brief description  | Type               | Part no. |
|---|--|--------------------|----------|
| <b>Plug connectors and cables</b>   |  |                    |          |
|  | Head A: female connector, M12, 5-pin, straight, A-coded<br>Head B: Flying leads<br>Cable: Sensor/actuator cable, PVC, unshielded, 2 m  | YF2A15-020VB5XLEAX | 2096239  |
|   | Head A: female connector, M12, 5-pin, straight, A-coded<br>Head B: Flying leads<br>Cable: Sensor/actuator cable, PVC, unshielded, 5 m  | YF2A15-050VB5XLEAX | 2096240  |
|   | Head A: female connector, M12, 5-pin, straight, A-coded<br>Head B: Flying leads<br>Cable: Sensor/actuator cable, PVC, unshielded, 10 m | YF2A15-100VB5XLEAX | 2096241  |
|  | Head A: female connector, M12, 5-pin, angled, A-coded<br>Head B: Flying leads<br>Cable: Sensor/actuator cable, PVC, unshielded, 2 m    | YG2A15-020VB5XLEAX | 2096215  |
|   | Head A: female connector, M12, 5-pin, angled, A-coded<br>Head B: Flying leads<br>Cable: Sensor/actuator cable, PVC, unshielded, 5 m    | YG2A15-050VB5XLEAX | 2096216  |
|   | Head A: female connector, M12, 5-pin, angled, A-coded<br>Head B: Flying leads<br>Cable: Sensor/actuator cable, PVC, unshielded, 10 m   | YG2A15-100VB5XLEAX | 2096217  |
|  | Head A: female connector, M12, 5-pin, straight<br>Cable: unshielded  | DOS-1205-G         | 6009719  |
|  | Head A: female connector, M12, 5-pin, angled<br>Head B: -<br>Cable: unshielded   | DOS-1205-W         | 6009720  |
| <b>Lenses and accessories</b>   |  |                    |          |
|   | Lens, 40 mm sensing distance, M20 x 0.75   | OBJ-210            | 2010945  |
|   | Lens, 10 mm sensing distance, M20 x 0.75   | OBJ-211            | 1004936  |
|   | Lens, 20 mm sensing distance, M20 x 0.75   | OBJ-212            | 1011506  |

## SICK AT A GLANCE

SICK is one of the leading manufacturers of intelligent sensors and sensor solutions for industrial applications. A unique range of products and services creates the perfect basis for controlling processes securely and efficiently, protecting individuals from accidents and preventing damage to the environment.

We have extensive experience in a wide range of industries and understand their processes and requirements. With intelligent sensors, we can deliver exactly what our customers need. In application centers in Europe, Asia and North America, system solutions are tested and optimized in accordance with customer specifications. All this makes us a reliable supplier and development partner.

Comprehensive services complete our offering: SICK LifeTime Services provide support throughout the machine life cycle and ensure safety and productivity.

For us, that is “Sensor Intelligence.”

## WORLDWIDE PRESENCE:

Contacts and other locations –[www.sick.com](http://www.sick.com)