

## LQ150X1LG82 LCD Module

### Product Specification

July 2008

XGA LCD Module featuring 350 nits brightness with 550:1 contrast and very fast response time.

LED backlight is rated at 50,000 hours.

Full Specifications Listing.

PREPARED BY :     DATE	<b>SHARP</b>	SPEC No. LD-20705A
APPROVED BY :     DATE		FILE No.
		ISSUE : 12. July. 2008
	MOBILE LIQUID CRYSTAL DISPLAY GROUP	PAGE : 20 pages
	SHARP CORPORATION	APPLICABLE GROUP
	<b>SPECIFICATION</b>	MOBILE LIQUID CRYSTAL DISPLAY GROUP

DEVICE SPECIFICATION FOR  
**TFT-LCD Module**  
 MODEL No.  
**LQ150X1LG82**

**These parts have corresponded with the RoHS directive.**

CUSTOMER'S APPROVAL  
 BY \_\_\_\_\_

BY *K. Shiono*  
 K. Shiono  
 General manager  
 ENGINEERING DEPARTMENT  
 MOBILE LIQUID CRYSTAL DISPLAY DIVISION III  
 MOBILE LIQUID CRYSTAL DISPLAY GROUP  
 SHARP CORPORATION

## 1. Application

This specification applies to the color 15.0 XGA TFT-LCD module LQ150X1LG82.

These specification sheets are the proprietary product of SHARP CORPORATION ("SHARP") and include materials protected under copyright of SHARP. Do not reproduce or cause any third party to reproduce them in any form or by any means, electronic or mechanical, for any purpose, in whole or in part, without the express written permission of SHARP.

The device listed in these specification sheets was designed and manufactured for use in general electronic equipment.

In case of using the device for applications such as control and safety equipment for transportation (controls of aircraft, trains, automobiles, etc.), rescue and security equipment and various safety related equipment which require higher reliability and safety, take into consideration that appropriate measures such as fail-safe functions and redundant system design should be taken.

Do not use the device for equipment that requires an extreme level of reliability, such as aerospace applications, telecommunication equipment (trunk lines), nuclear power control equipment and medical or other equipment for life support.

SHARP assumes no responsibility for any damage resulting from the use of the device which does not comply with the instructions and the precautions specified in these specification sheets.

Confirm "11. Handling Precautions" item when you use the device.

Contact and consult with a SHARP sales representative for any questions about this device.

## 2. Overview

This module is a color active matrix LCD module incorporating amorphous silicon TFT (Thin Film Transistor). It is composed of a color TFT-LCD panel, driver ICs, control circuit, power supply circuit and a White-LED Backlight unit. Graphics and texts can be displayed on a 1024 × RGB × 768 dots panel with about 16 million colors by using LVDS (Low Voltage Differential Signaling) and supplying +3.3V DC supply voltages for TFT-LCD panel driving and supply voltage for backlight. LED Backlight-driving DC/DC converter is not built in this module. Viewing angle is 6 o'clock direction.

## 3. Mechanical Specifications

Parameter	Specifications	Unit
Display size	38 (Diagonal)	cm
	15.0 (Diagonal)	Inch
Active area	304.1 (H) × 228.1 (V)	mm
Pixel format	1024 (H) × 768 (V)	Pixel
	(1 pixel = R+G+B dots)	
Pixel pitch	0.297 (H) × 0.297 (V)	mm
Pixel configuration	R, G, B vertical stripe	
Display mode	Normally white	
Unit outline dimensions *1	326.0(W) × 252.0(H) × 13.7(D)	mm
Mass	1200 (max)	g
Surface treatment	Anti-glare and hard-coating 3H (Haze value = 25)	

\*1.Note: Excluding back light cables (The backlight cable is not attached to the LCD unit.)

The thickness of module (D) doesn't contain the projection.

Outline dimensions are shown in Fig.1.

## 4. Input Terminals

## 4-1. TFT-LCD panel driving

CN1 (Interface signals and +3.3V DC power supply)

Using connectors : DF14H-20P-1.25H (Hirose Electric Co., Ltd.)

Corresponding connectors : DF14-20S-1.25C(Hirose Electric Co., Ltd.)

( ) Please do not use it besides corresponding connector

Pin No.	Symbol	Function	Remark
1	Vcc	+3.3V Power supply	
2	Vcc	+3.3V Power supply	
3	GND		
4	GND		
5	RXIN0-	Receiver signal (-)	LVDS
6	RXIN0+	Receiver signal (+)	LVDS
7	GND		
8	RXIN1-	Receiver signal (-)	LVDS
9	RXIN1+	Receiver signal (+)	LVDS
10	GND		
11	RXIN2-	Receiver signal (-)	LVDS
12	RXIN2+	Receiver signal (+)	LVDS
13	GND		
14	RXCKIN-	Clock signal (-)	LVDS
15	RXCKIN+	Clock signal (+)	LVDS
16	GND		
17	RXIN3-	Receiver signal (-)	LVDS
18	RXIN3+	Receiver signal (+)	LVDS
19	HANTEN	Horizontal/Vertical display mode select signal	【note1】 , 【note2】
20	LVDS_SET	LVDS_SET	【note2】 , 【note3】

## 【note1】

H A N T E N = “ L O W ”



H A N T E N = “ H i g h ”



## 【note2】

Pull-up resistor lower than 12kΩ can be used.

## 4-2. Data Mapping

## 1) 8 bit input

【note3】 pin assignment with LVDS\_SET pin (Thine: THC63LVDF83A)

Transmitter		20pin LVDS_SET	
Pin No	Data	= L (GND)	= H (3.3V)
51	TA0	R2	R0 (LSB)
52	TA1	R3	R1
54	TA2	R4	R2
55	TA3	R5	R3
56	TA4	R6	R4
3	TA5	R7 (MSB)	R5
4	TA6	G2	G0 (LSB)
6	TB0	G3	G1
7	TB1	G4	G2
11	TB2	G5	G3
12	TB3	G6	G4
14	TB4	G7 (MSB)	G5
15	TB5	B2	B0 (LSB)
19	TB6	B3	B1
20	TC0	B4	B2
22	TC1	B5	B3
23	TC2	B6	B4
24	TC3	B7 (MSB)	B5
27	TC4	High or low	High or low
28	TC5	High or low	High or low
30	TC6	DE	DE
50	TD0	R0 (LSB)	R6
2	TD1	R1	R7 (MSB)
8	TD2	G0 (LSB)	G6
10	TD3	G1	G7 (MSB)
16	TD4	B0 (LSB)	B6
18	TD5	B1	B7 (MSB)
25	TD6	(NA)	(NA)
31	CLK IN	CLK	CLK

<LVDS\_SET = L >

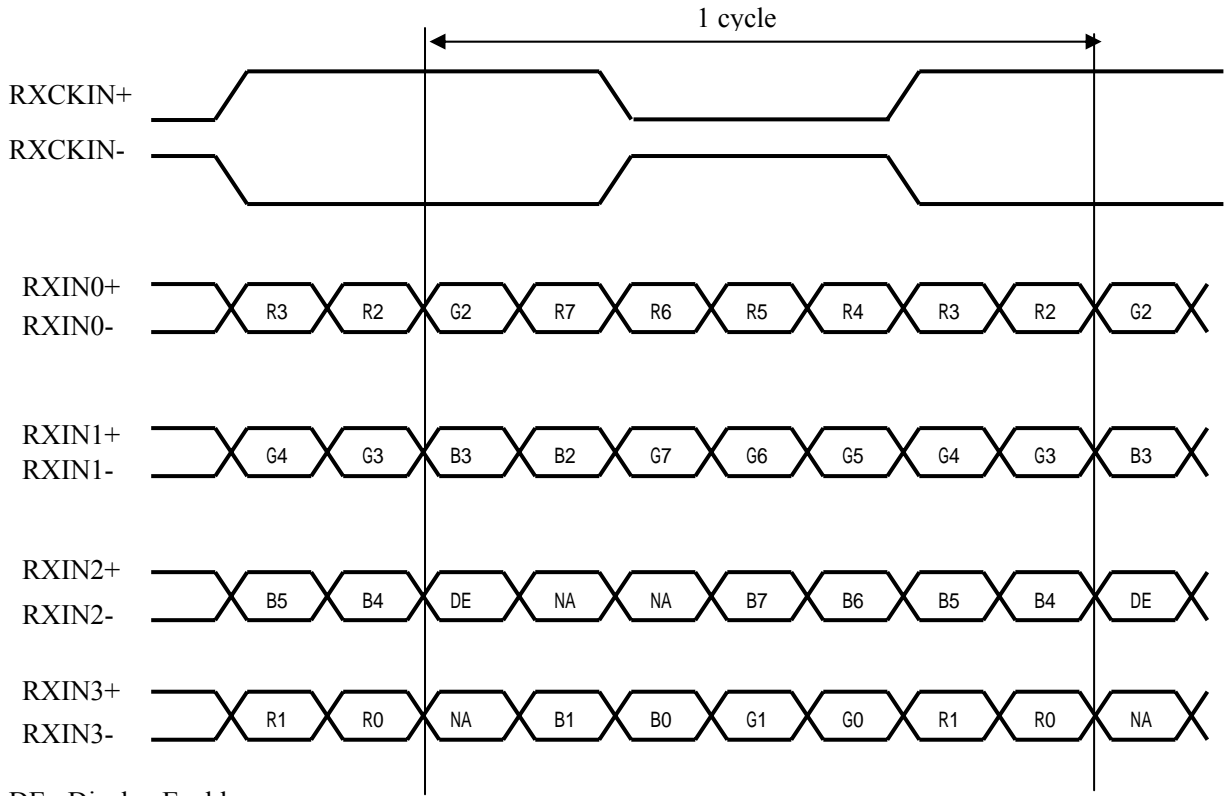

DE : Display Enable  
 NA : Not Available

<LVDS\_SET = H >

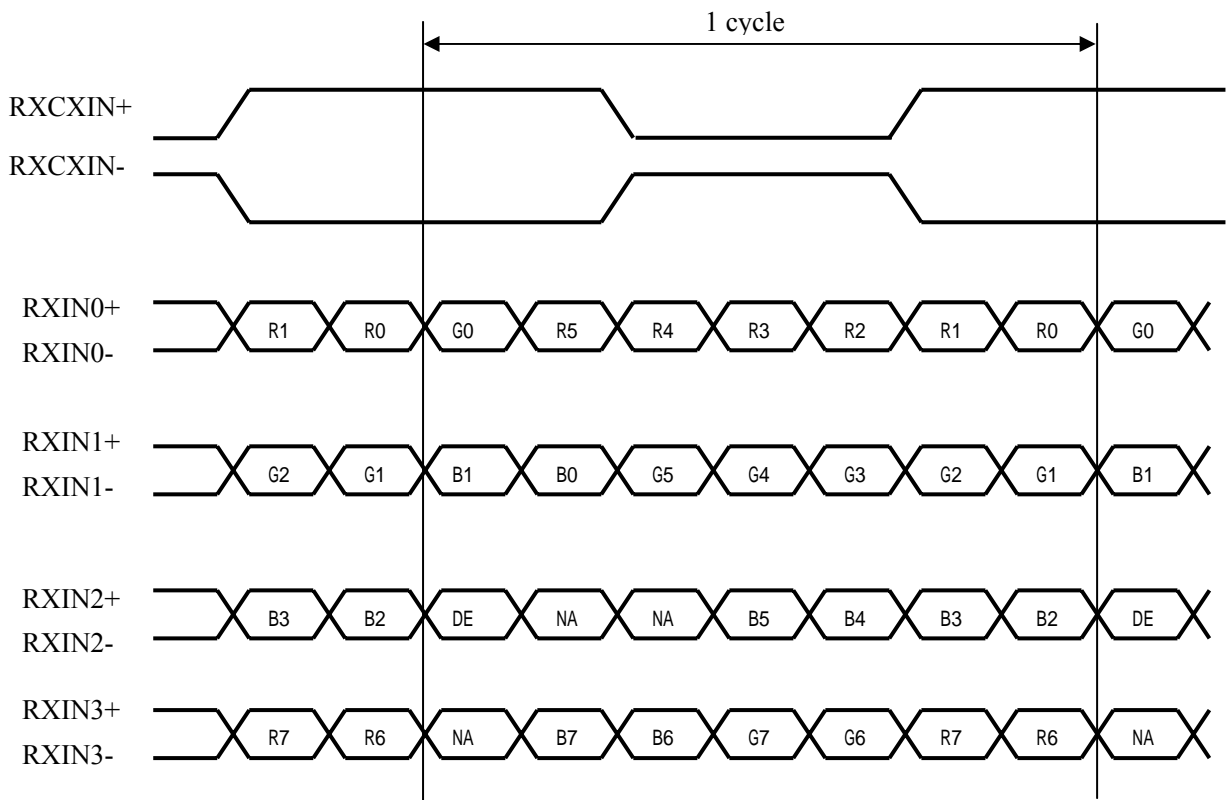

DE : Display Enable  
 NA : Not Available

## 2) 6 bit input

【note4】 pin assignment with LVDS\_SET pin (Thine: THC63LVDF83A)

Transmitter		20pin LVDS_SET	
Pin No	Data	= L (GND)	= H (3.3V)
51	TA0	R0 (LSB)	-
52	TA1	R1	-
54	TA2	R2	-
55	TA3	R3	-
56	TA4	R4	-
3	TA5	R5 (MSB)	-
4	TA6	G0 (LSB)	-
6	TB0	G1	-
7	TB1	G2	-
11	TB2	G3	-
12	TB3	G4	-
14	TB4	G5 (MSB)	-
15	TB5	B0 (LSB)	-
19	TB6	B1	-
20	TC0	B2	-
22	TC1	B3	-
23	TC2	B4	-
24	TC3	B5 (MSB)	-
27	TC4	High or low	-
28	TC5	High or low	-
30	TC6	DE	-
50	TD0	GND	-
2	TD1	GND	-
8	TD2	GND	-
10	TD3	GND	-
16	TD4	GND	-
18	TD5	GND	-
25	TD6	(NA)	-
31	CIKIN	CLK	-

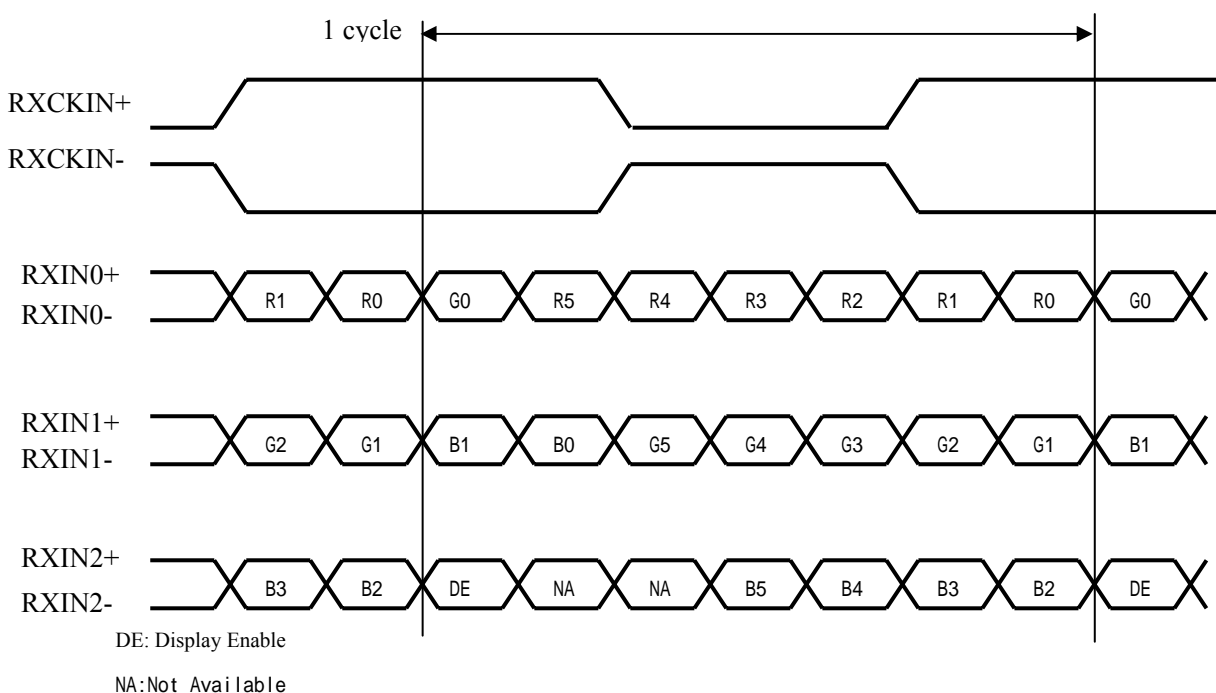



## 4-4. Backlight

CN2 Used connector : 50156806 (Molex)

Corresponding connector : 5013300600 (Molex)

Pin no.	symbol	function
1	+ch3	Power supply for LED (Ch3 High voltage side)
2	+ch2	Power supply for LED (Ch2 High voltage side)
3	+ch1	Power supply for LED (Ch1 High voltage side)
4	- ch1	Power supply for LED (Ch1 Low voltage side)
5	- ch2	Power supply for LED (Ch2 Low voltage side)
6	- ch3	Power supply for LED (Ch3 Low voltage side)

## 5. Absolute Maximum Ratings

Parameter	Symbol	Condition	Ratings	Unit	Remark
Supply voltage	V <sub>cc</sub>	T <sub>a</sub> =25	-0.3 ~ +4.0	V	
Input voltage	V <sub>I</sub>	T <sub>a</sub> =25	-0.3 ~ V <sub>cc</sub> +0.3	V	
Storage temperature	T <sub>STG</sub>	-	-25 ~ +60		【Note5】
Operating temperature	T <sub>opa</sub>		0 (Ambient) ~ +60 (Panel surface)		

【Note5】 Humidity : 95%RH Max. ( T<sub>a</sub> 40 )Maximum wet-bulb temperature at 39 or less. ( T<sub>a</sub>>40 )

No condensation.

## 6. Recommended operation condition

Parameter	Symbol	Min.	Typ.	Max.	Unit	Remark
Supply voltage	V <sub>cc</sub>	+3.0	+3.3	+3.6	V	【Note6】
LVDS Signals	V <sub>L</sub>	0		2.4	V	【Note7】
Input voltage	V <sub>I</sub>	0		V <sub>cc</sub>	V	【Note8】
Surface temperature	T <sub>opa</sub>	0		+60		【Note9】

**【Note6】** On-off conditions for supply voltage

- 0<t1 15ms
- 0<t2 10ms
- 0<t3 100ms
- 0<t4 1s
- 200ms<t5

Vcc-dip conditions

- 1) 2.5V Vcc < 3.0V  
td 10ms
- 2) Vcc<2.5V

Vcc-dip conditions should also follow the On-off conditions for supply voltage

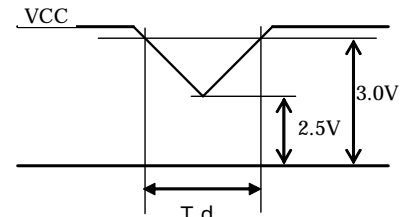
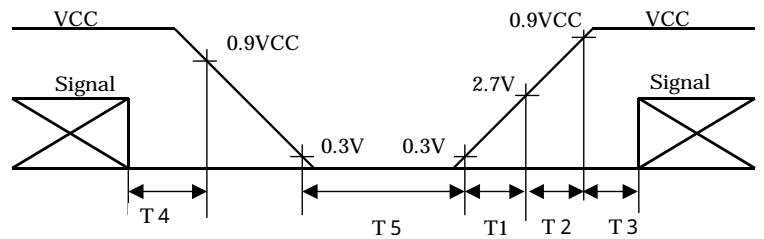

**【Note7】** RXIN0-, RXIN0+,RXIN1-,RXIN1+,RXIN2-,RXIN2+,  
RXCKIN-,RXCKIN+,RXIN3-,RXIN3+

**【Note8】** LVDS\_SET、 HANTEN

**【Note9】** Humidity: 95%RH Max. at Ta=<40°C.

Maximum wet-bulb temperature at 39°C or less at Ta>40

No condensation.

Maximum value : Panel surface temperature

7. Electrical Characteristics

7-1. TFT-LCD panel driving

Ta = 25

Parameter		Symbol	Min.	Typ.	Max.	Unit	Remark
Vcc	Supply voltage	Vcc	+3.0	+3.3	+3.6	V	-
	Current dissipation	Icc	-	350	450	mA	<b>【Note11】</b>
Permissive input ripple voltage		V <sub>RF</sub>	-	-	100	mVp-p	Vcc=+3.3V
Differential input Threshold voltage	High	V <sub>TH</sub>	-	-	+100	mV	V <sub>CM</sub> =+1.2V <b>【Note10】</b>
	Low	V <sub>TL</sub>	-100	-	-	mV	
Input voltage width for LVDS receiver		V <sub>i</sub>	0	-	2.4	V	-
Input voltage	High	V <sub>IH</sub>	2.1	-	-	V	<b>【Note12】</b>
	Low	V <sub>IL</sub>	-	-	0.6	V	
Terminal resistor		R <sub>T</sub>	-	100	-		Differential input

**【Note10】** V<sub>CM</sub> : Common mode voltage of LVDS driver.

**【Note11】** Typical current situation : 253-gray-bar pattern

Vcc=+3.3V, fck=65MHz, Ta=25

Gray scale : GS(n)

**【Note12】** HANTEN, LVDS\_SET

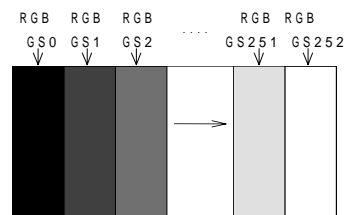

## 7-2. Backlight

The backlight system is an edge-lighting type with white-LED.

The characteristics of LED are shown in the following table.

(It is usually required to measure under the following condition.

condition:  $I_f=100\text{mA}/\text{Constant current drive}, T_a=25 \pm 2$  )

Parameter	Symbol	Min.	Typ.	Max.	Unit	Remark
LED voltage	$V_L$	-	32	-	V	
LED current range	$I_L$	-	100	105	mA	Value for one channel
Number of circuit channel		-	3	-		[Note 13]
Lamp power consumption	$W_L$	-	9.6	-	W	[Note 14]
Life time ( LCD module )	$L_L$	-	50,000	-	Hour	[Note 15、 16]

\* LED : NICHIA CORPORATION ( NFSW-TYPE)

[Note 13] The LED backlight is composed of 3 channels which 10 LED is connected in series.

[Note 14] Calculated value for reference (  $I_L \times V_L \times 3$  channel)

[Note 15] Lighting condition:

- The state of the LCD module installation: Landscape position and standing position
- Atmosphere temperature: 25
- Lighting current: 100mA (Constant current drive / Continuous turning on)

Definition of Life time:

Brightness becomes 50% of the original value .(under condition )

[Note 16] In the method of the parallel connection of the input of each channel and the drive, an excessive current flows to the channel side where the voltage is low, and, as a result, there is a possibility of causing the LED longevity decrease.

It is preferable to do the fixed current drive only for each channel to each channel.

## 8. Timing characteristics of input signals

### 8-1. Timing characteristics

Parameter		Symbol	Min.	Typ.	Max.	Unit
Clock signal	Frequency	$1/T_c$	50.0	65.0	80.0	MHz
ENAB signal	Horizontal period	TH	1056	1344	1720	clock
			16.0	20.7	23.4	$\mu\text{s}$
	Horizontal period (High)	THd	1024	1024	1024	clock
	Vertical Frequency	$f_v$	54	60	77	Hz
	Vertical period	TV	773	806	990	line
			12.98	16.66	18.51	ms
Vertical period (High)	TVd	768	768	768	line	

【Note】 In case of using the long vertical period, the deterioration of display quality, flicker etc. may occur.

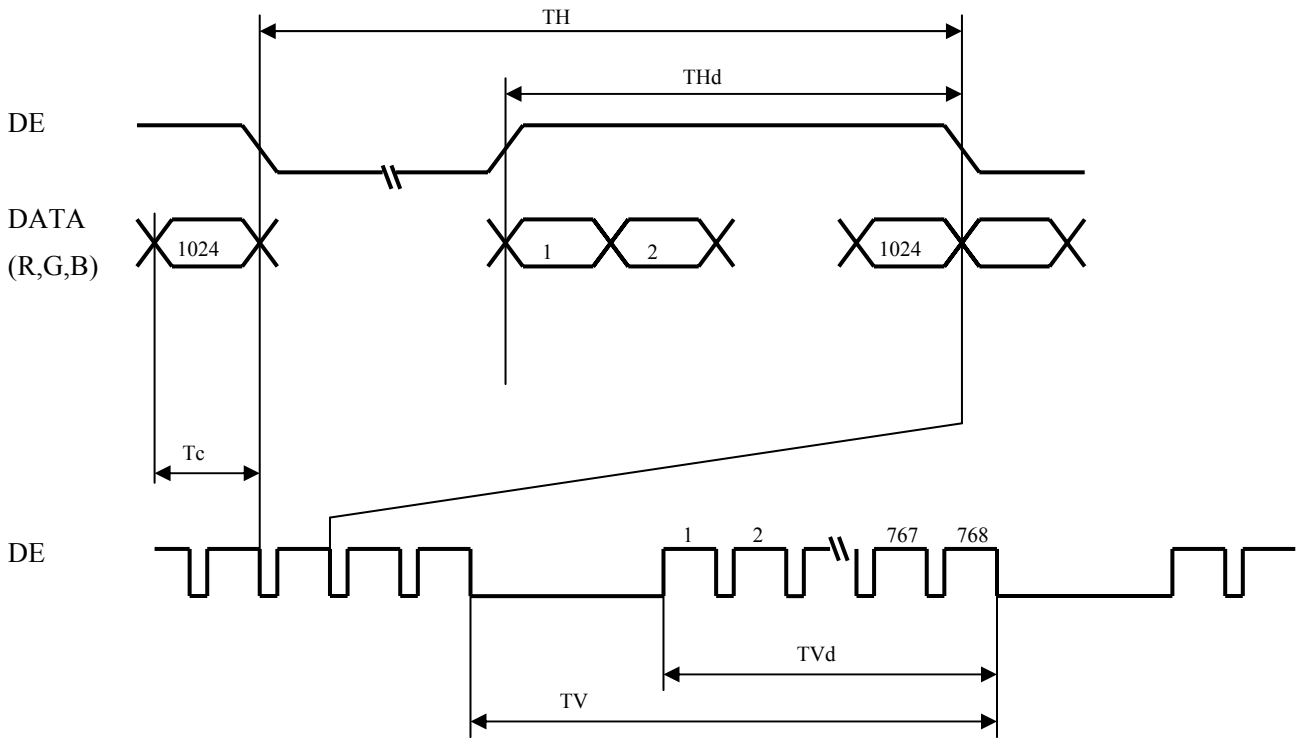

8-2. Input Data Signals and Display Position on the screen

R1	G1	B1	R2	G2	B2
(1, 1)	(1, 2)				

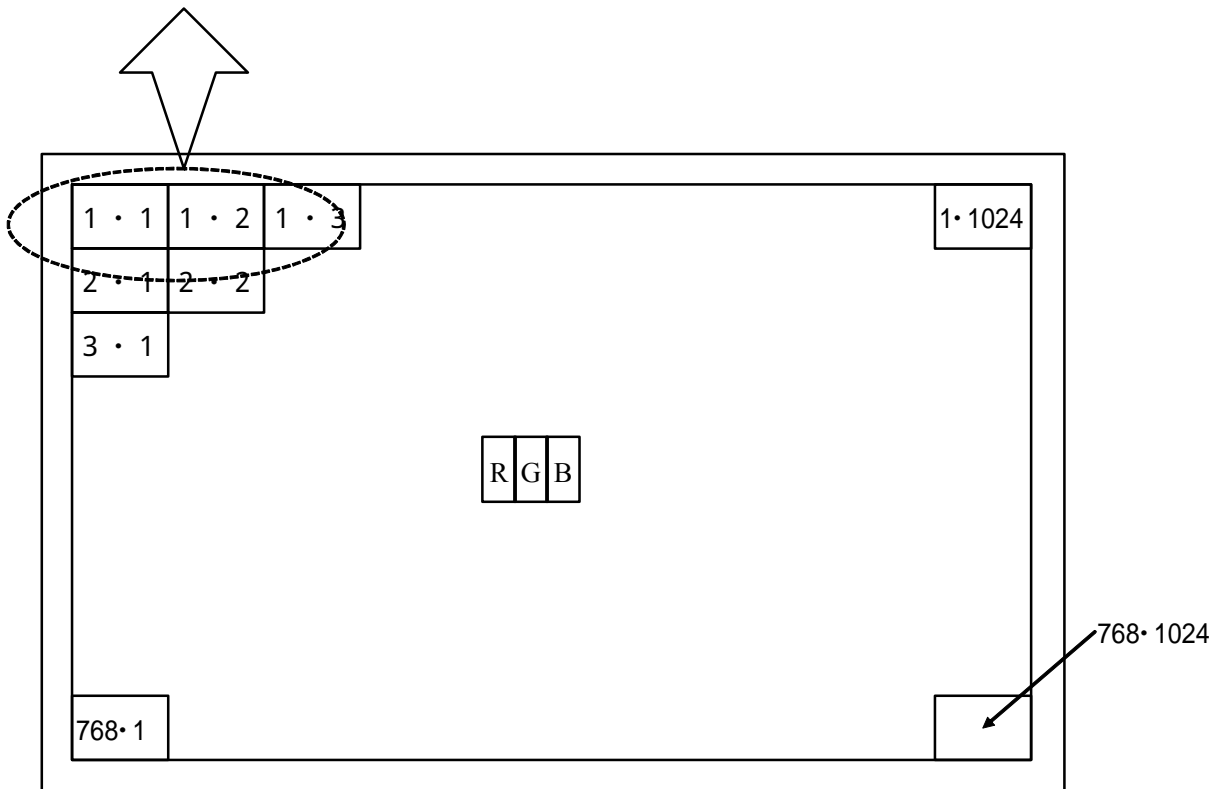

Display Position of Data (V,H)

9. Input Signals, Basic Display Colors and Gray Scale of Each Color

9-1. 8bit input

	Colors & Gray scale	Data signal																								
		Gray Scale	R0	R1	R2	R3	R4	R5	R6	R7	G0	G1	G2	G3	G4	G5	G6	G7	B0	B1	B2	B3	B4	B5	B6	B7
Basic Color	Black	-	0	0	0	0	0	0	0	0	0	0	0	0	0	0	0	0	0	0	0	0	0	0	0	0
	Blue	-	0	0	0	0	0	0	0	0	0	0	0	0	0	0	0	0	X	X	1	1	1	1	1	1
	Green	-	0	0	0	0	0	0	0	0	X	X	1	1	1	1	1	1	0	0	0	0	0	0	0	0
	Cyan	-	0	0	0	0	0	0	0	0	X	X	1	1	1	1	1	1	X	X	1	1	1	1	1	1
	Red	-	X	X	1	1	1	1	1	1	0	0	0	0	0	0	0	0	0	0	0	0	0	0	0	0
	Magenta	-	X	X	1	1	1	1	1	1	0	0	0	0	0	0	0	0	X	X	1	1	1	1	1	1
	Yellow	-	X	X	1	1	1	1	1	1	X	X	1	1	1	1	1	1	0	0	0	0	0	0	0	0
	White	-	X	X	1	1	1	1	1	1	X	X	1	1	1	1	1	1	X	X	1	1	1	1	1	1
Gray Scale of Red	Black	GS0	0	0	0	0	0	0	0	0	0	0	0	0	0	0	0	0	0	0	0	0	0	0	0	0
	↑	GS1	1	0	0	0	0	0	0	0	0	0	0	0	0	0	0	0	0	0	0	0	0	0	0	0
	Darker	GS2	0	1	0	0	0	0	0	0	0	0	0	0	0	0	0	0	0	0	0	0	0	0	0	0
	↑	↓	↓							↓							↓									
	↓	↓	↓							↓							↓									
	Brighter	GS250	0	1	0	1	1	1	1	1	0	0	0	0	0	0	0	0	0	0	0	0	0	0	0	0
	↓	GS251	1	1	0	1	1	1	1	1	0	0	0	0	0	0	0	0	0	0	0	0	0	0	0	0
	Red	GS252	X	X	1	1	1	1	1	1	0	0	0	0	0	0	0	0	0	0	0	0	0	0	0	0
Gray Scale of Green	Black	GS0	0	0	0	0	0	0	0	0	0	0	0	0	0	0	0	0	0	0	0	0	0	0	0	0
	↑	GS1	0	0	0	0	0	0	0	0	1	0	0	0	0	0	0	0	0	0	0	0	0	0	0	0
	Darker	GS2	0	0	0	0	0	0	0	0	0	1	0	0	0	0	0	0	0	0	0	0	0	0	0	0
	↑	↓	↓							↓							↓									
	↓	↓	↓							↓							↓									
	Brighter	GS250	0	0	0	0	0	0	0	0	0	1	0	1	1	1	1	1	0	0	0	0	0	0	0	0
	↓	GS251	0	0	0	0	0	0	0	0	1	1	0	1	1	1	1	1	0	0	0	0	0	0	0	0
	Green	GS252	0	0	0	0	0	0	0	0	X	X	1	1	1	1	1	1	0	0	0	0	0	0	0	0
Gray Scale of Blue	Black	GS0	0	0	0	0	0	0	0	0	0	0	0	0	0	0	0	0	0	0	0	0	0	0	0	0
	↑	GS1	0	0	0	0	0	0	0	0	0	0	0	0	0	0	0	0	1	0	0	0	0	0	0	0
	Darker	GS2	0	0	0	0	0	0	0	0	0	0	0	0	0	0	0	0	0	1	0	0	0	0	0	0
	↑	↓	↓							↓							↓									
	↓	↓	↓							↓							↓									
	Brighter	GS250	0	0	0	0	0	0	0	0	0	0	0	0	0	0	0	0	0	1	0	1	1	1	1	1
	↓	GS251	0	0	0	0	0	0	0	0	0	0	0	0	0	0	0	0	1	1	0	1	1	1	1	1
	Blue	GS252	0	0	0	0	0	0	0	0	0	0	0	0	0	0	0	0	X	X	1	1	1	1	1	1

0 : Low level voltage, 1 : High level voltage. X : Don't care

Each basic color can be displayed in 253 gray scales from 8 bit data signals. According to the combination of total 24 bit data signals, the 16-million-color display can be achieved on the screen.

## 9-2. 6bit input

	Colors & Gray scale	Data signal																		
		Gray Scale	R0	R1	R2	R3	R4	R5	G0	G1	G2	G3	G4	G5	B0	B1	B2	B3	B4	B5
Basic Color	Black	-	0	0	0	0	0	0	0	0	0	0	0	0	0	0	0	0	0	0
	Blue	-	0	0	0	0	0	0	0	0	0	0	0	0	1	1	1	1	1	1
	Green	-	0	0	0	0	0	0	1	1	1	1	1	1	0	0	0	0	0	0
	Cyan	-	0	0	0	0	0	0	1	1	1	1	1	1	1	1	1	1	1	1
	Red	-	1	1	1	1	1	1	0	0	0	0	0	0	0	0	0	0	0	0
	Magenta	-	1	1	1	1	1	1	0	0	0	0	0	0	1	1	1	1	1	1
	Yellow	-	1	1	1	1	1	1	1	1	1	1	1	1	0	0	0	0	0	0
	White	-	1	1	1	1	1	1	1	1	1	1	1	1	1	1	1	1	1	1
Gray Scale of Red	Black	GS0	0	0	0	0	0	0	0	0	0	0	0	0	0	0	0	0	0	0
	↑	GS1	1	0	0	0	0	0	0	0	0	0	0	0	0	0	0	0	0	0
	Darker	GS2	0	1	0	0	0	0	0	0	0	0	0	0	0	0	0	0	0	0
	↑	↓	↓					↓					↓							
	↓	↓	↓					↓					↓							
	Brighter	GS61	1	0	1	1	1	1	0	0	0	0	0	0	0	0	0	0	0	0
	↓	GS62	0	1	1	1	1	1	0	0	0	0	0	0	0	0	0	0	0	0
	Red	GS63	1	1	1	1	1	1	0	0	0	0	0	0	0	0	0	0	0	0
Gray Scale of Green	Black	GS0	0	0	0	0	0	0	0	0	0	0	0	0	0	0	0	0	0	0
	↑	GS1	0	0	0	0	0	0	1	0	0	0	0	0	0	0	0	0	0	0
	Darker	GS2	0	0	0	0	0	0	0	1	0	0	0	0	0	0	0	0	0	0
	↑	↓	↓					↓					↓							
	↓	↓	↓					↓					↓							
	Brighter	GS61	0	0	0	0	0	0	1	0	1	1	1	1	0	0	0	0	0	0
	↓	GS62	0	0	0	0	0	0	0	1	1	1	1	1	0	0	0	0	0	0
	Green	GS63	0	0	0	0	0	0	1	1	1	1	1	1	0	0	0	0	0	0
Gray Scale of Blue	Black	GS0	0	0	0	0	0	0	0	0	0	0	0	0	0	0	0	0	0	0
	↑	GS1	0	0	0	0	0	0	0	0	0	0	0	0	1	0	0	0	0	0
	Darker	GS2	0	0	0	0	0	0	0	0	0	0	0	0	0	1	0	0	0	0
	↑	↓	↓					↓					↓							
	↓	↓	↓					↓					↓							
	Brighter	GS61	0	0	0	0	0	0	0	0	0	0	0	0	1	0	1	1	1	1
	↓	GS62	0	0	0	0	0	0	0	0	0	0	0	0	0	1	1	1	1	1
	Blue	GS63	0	0	0	0	0	0	0	0	0	0	0	0	1	1	1	1	1	1

0 : Low level voltage,            1 : High level voltage.

Each basic color can be displayed in 64 gray scales from 6 bit data signals. According to the combination of total 18 bit data signals, the 262,144-color display can be achieved on the screen.

## 10. Optical Characteristics

Ta=25 , Vcc =+3.3V

Parameter		Symbol	Condition	Min.	Typ.	Max.	Unit	Remark
Viewing angle range	Vertical	11	CR 10	30	45	-	Deg.	【Note17,20】
		12		45	55	-	Deg.	
	Horizontal	21, 22		50	60	-	Deg.	
Contrast ratio		C R	=0 °	400	550	-		【Note18,20】
Response Time	Rise	r	=0 °	-	2	-	ms	【Note19,20】
	Fall	d		-	6	-	ms	
Chromaticity of White		x		0.272	0.330	0.392		【Note20】
		y		0.296	0.351	0.418		
Chromaticity of Red		x		0.546	0.595	0.646		
		y		0.295	0.343	0.391		
Chromaticity of Green		x		0.306	0.358	0.409		
		y		0.540	0.595	0.652		
Chromaticity of Blue		x		0.106	0.154	0.204		
		y		0.076	0.127	0.183		
Luminance of white		YL	280	350	-	cd/m <sup>2</sup>	It=100mArms Ta=25	
White Uniformity		w	-	-	1.25		【Note21】	

The measurement shall be executed 30 minutes after lighting at rating.

The optical characteristics shall be measured in a dark room or equivalent state with the method shown in Fig.2 below.

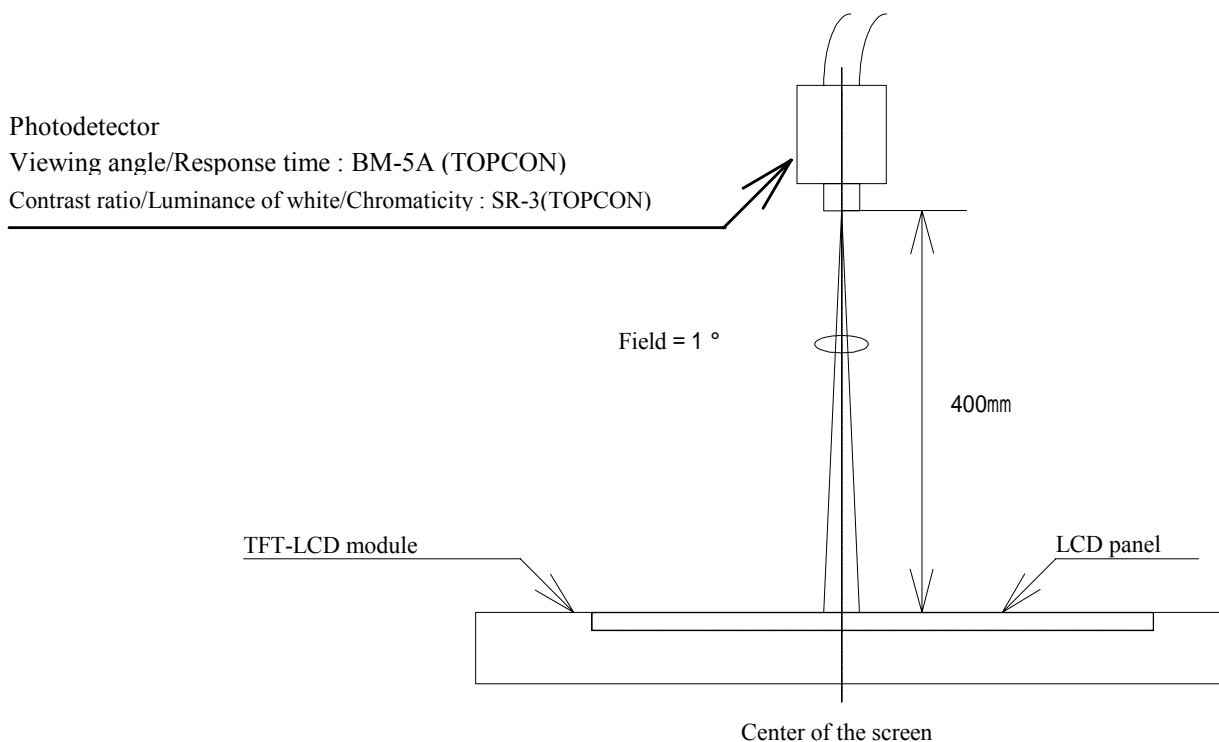
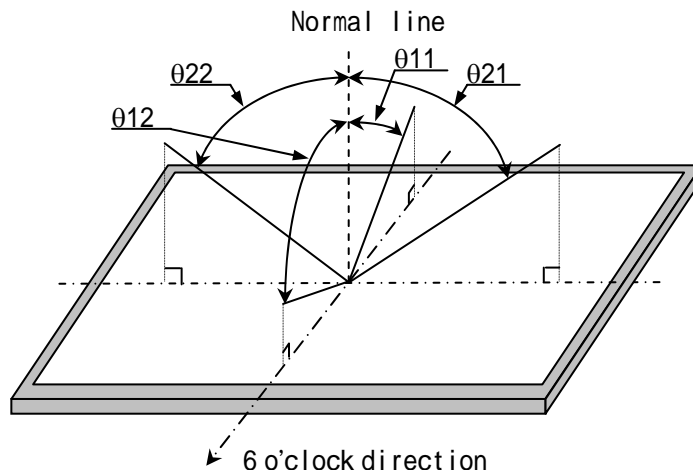

Fig.2 Optical characteristics measurement method

【Note17】 Definitions of viewing angle range:



【Note18】 Definition of contrast ratio:

The contrast ratio is defined as the following.

$$\text{Contrast Ratio (CR)} = \frac{\text{Luminance (brightness) with all pixels white}}{\text{Luminance (brightness) with all pixels black}}$$

【Note19】 Definition of response time:

The response time is defined as the following figure and shall be measured by switching the input signal for "black" and "white".

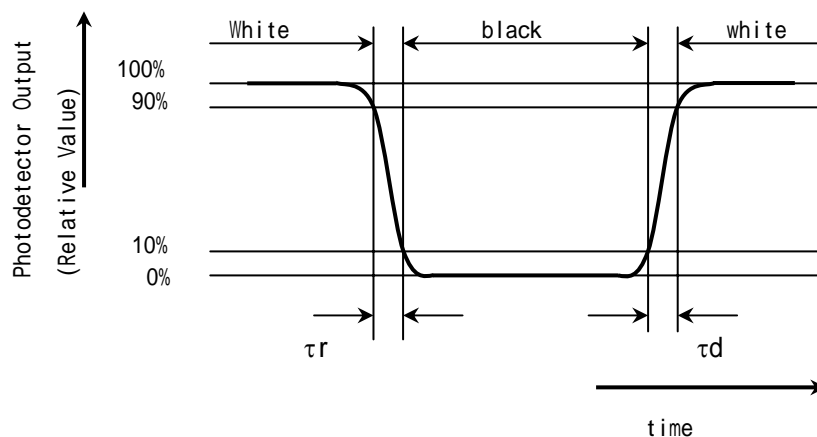

【Note20】 This shall be measured at center of the screen.

【Note21】 Definition of white uniformity:

White uniformity is defined as the following with five measurements (A ~ E).

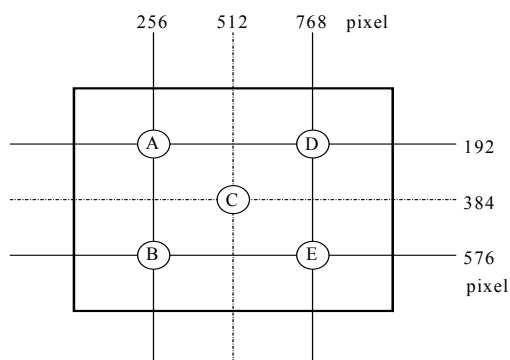

$$w = \frac{\text{Maximum Luminance of five points (brightness)}}{\text{Minimum Luminance of five points (brightness)}}$$



## 11. Handling Precautions

- a) Be sure to turn off the power supply when inserting or disconnecting the cable.
- b) Be sure to design the cabinet so that the module can be installed without any extra stress such as warp or twist.
- c) Since the front polarizer is easily damaged, pay attention not to scratch it.  
Blow away dust on the polarizer with antistatic N<sub>2</sub> blow. It is undesirable to wipe off because a polarizer is sensitive. It is recommended to peel off softly using the adhesive tape when soil or finger oil is stuck to the polarizer. When unavoidable, wipe off carefully with a cloth for wiping lenses.
- d) Wipe off water drop immediately. Long contact with water may cause discoloration or spots.
- e) When the panel surface is soiled, wipe it with absorbent cotton or other soft cloth.
- f) Since the panel is made of glass, it may break or crack if dropped or bumped on hard surface.  
Handle with care.
- g) Since CMOS LSI is used in this module, take care of static electricity and injure the human earth when handling. Observe all other precautionary requirements in handling components.
- h) Since there is a circuit board in the module back, stress is not added at the time of a design assembly. Please make it like. If stress is added, there is a possibility that circuit parts may be damaged.
- i) Protection film is attached to the module surface to prevent it from being scratched .  
Peel the film off slowly , just before the use, with strict attention to electrostatic charges.  
Blow off 'dust' on the polarizer by using an ionized nitrogen.
- j) The polarizer surface on the panel is treated with Anti-Glare for low reflection. In case of attaching protective board over the LCD, be careful about the optical interface fringe etc. which degrades display quality.
- k) Do not expose the LCD panel to direct sunlight. Lightproof shade etc. should be attached when LCD panel is used under such environment.
- l) Connect GND to 4 place of mounting holes to stabilize against EMI and external noise.
- m) When handling LCD modules and assembling them into cabinets, please avoid that long-terms storage in the environment of oxidization or deoxidization gas and the use of such materials as reagent, solvent, adhesive, resin, etc. which generate these gasses, may cause corrosion and discoloration of the modules. Do not use the LCD module under such environment.
- n) When install LCD modules in the cabinet, please tighten with “torque = (0.34)N• m(Max).  
Be sure to confirm it in the same condition as it is installed in your instrument.
- o) Liquid crystal contained in the panel may leak if the LCD is broken. Rinse it as soon as possible if it gets inside your eye or mouth by mistake.
- p) Notice : Never dismantle the module , because it will cause failure.  
Please do not peel off the Black tape pasted to the product. However, the panel protection film is excluded.
- q) Be careful when using it for long time with fixed pattern display as it may cause accidental image.  
(Please use a screen saver etc., in order to avoid an afterimage.)
- r) Adjusting volume have been set optimally before shipment, so do not change any adjusted value.  
If adjusted value is changed, the specification may not be satisfied.
- s) If a minute particle enters in the module and adheres to an optical material, it may cause display non-uniformity issue, etc. Therefore, fine-pitch filters have to be installed to cooling and inhalation hole if you intend to install a fan.
- t) The LED used for this product is very sensitive to the temperature. Luminance decreases rapidly when it is used for a long time under the environment of the high temperature. Please consult our company when it is used under the environment like the above mentioned.
- u) Please make the LED lighting power supply an independent fixed current drive composition in each channel.  
When each channel of LED is driven parallel, the display fineness and longevity might be deteriorated.

## 12. Packing form

Product countries / Areas	CHINA
Piling number of cartons	6
Package quantity in one carton	10pcs
Carton size(TYP)	460 × 400 × 345(H) [mm]
Total mass of one carton filled with full modules	14.0 Kg (typ)
Packing form is shown	Fig.3

## 13 . Reliability test items

No	Test item	Conditions	
1	High temperature & high humidity operation test	Ta = 40 ; 95%RH 240h (No condensation)	
2	High temperature operation test	Tp = 60 240h	Panel Surface
3	High temperature storage test	Ta = 60 240h	
4	Low temperature operation test	Ta = 0 240h	
5	Low temperature storage test	Ta = -25 240h	
6	Vibration test (non- operating)	Waveform : Sine wave Frequency : 10 ~ 57Hz/Vibration width (one side) : 0.076mm : 57 ~ 500Hz/Gravity : 9.8m/s <sup>2</sup> Sweep time : 11minutes Test period : 3 hours (1 hour for each direction of X,Y,Z)	【Note】
7	Shock test (non- operating)	Max. gravity : 490m/s <sup>2</sup> Pulse width : 11ms, half-sine wave Direction : ± X, ± Y, ± Z, once for each direction.	
8	Thermal shock test (Storage)	Ta=-25 ~ 60 ; 5 cycles Test period : 10 hours (1 hour for each temperature)	【Note】
9	Altitude	Ta=50 ,70kPa,3,048m(10,000ft), t=24h (Operating) Ta=60 ,12kPa,15,240m(50,000ft), t=24h (Storage)	

【Note】 A gap of panel shall not occur by vibration or the shock.

## 【Result Evaluation Criteria】

Under the display quality test conditions with normal operation state, these shall be no change which may affect practical display function. (normal operation state : Temperature:15 ~ 35 , Humidity:45 ~ 75%, Atmospheric pressure:86 ~ 106kpa)

14. Others

14-1. Lot No. Label:

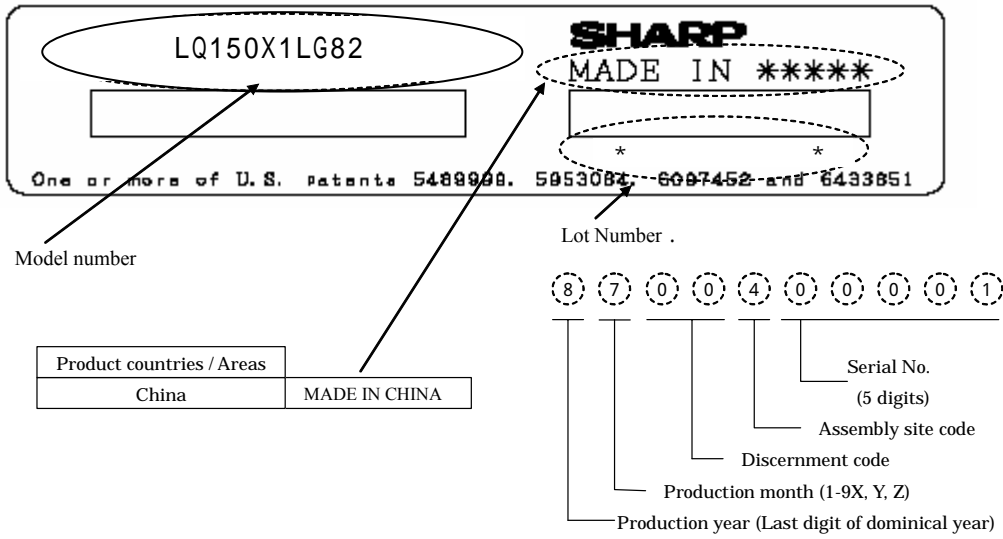

14-2. Packing box Label:

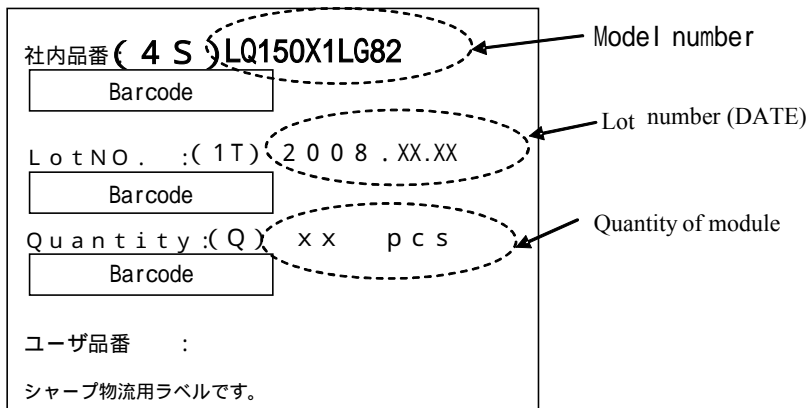

R.C. ( RoHs Compliance ) means these parts have corresponded with the RoHs directive.

14-3. If any problem occurs in relation to the description of this specification, it shall be resolved through discussion with spirit of cooperation.

## 15. Storage conditions

<Environmental condition range of storage temperature and humidity>

Temperature 0 to 40 degrees Celsius

Relative humidity 95% and below

[Note] Please refer below as a mean value of the environmental conditions.

Summer time temperature 20 to 35 degrees Celsius

humidity 85% and below

Winter time temperature 5 to 15 degrees Celsius

humidity 85% and below

Please maintain within 240 hours of accumulated length of storage time, with conditions of 40 degrees Celsius and room humidity of 95%.

Direct sun light Please keep the product in a dark room or cover the product to protect from direct sun light.

Atmospheric condition Please refrain from keeping the product with possible corrosive gas or volatile flux.

Prevention of dew \* Please store the product carton either on a wooden pallet or a stand / rack to prevent dew. Do not place directly on the floor. In addition, to obtain moderate ventilation in between the pallet's top and bottom surfaces, pile the cartons up in a single direction and in order.

\* Please place the product cartons away from the storage wall.

\* Please maintain the storage area with an appropriate ventilation. It is recommendable to furnish the storage area with equipments such as ventilation systems.

\* Please maintain the ambient temperature within the range of natural environmental fluctuation.

Storage period Within above mentioned conditions, maximum storage period should be one year.

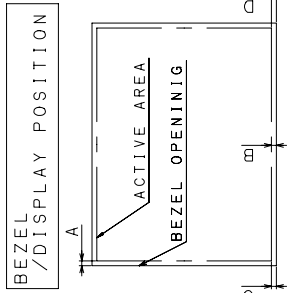
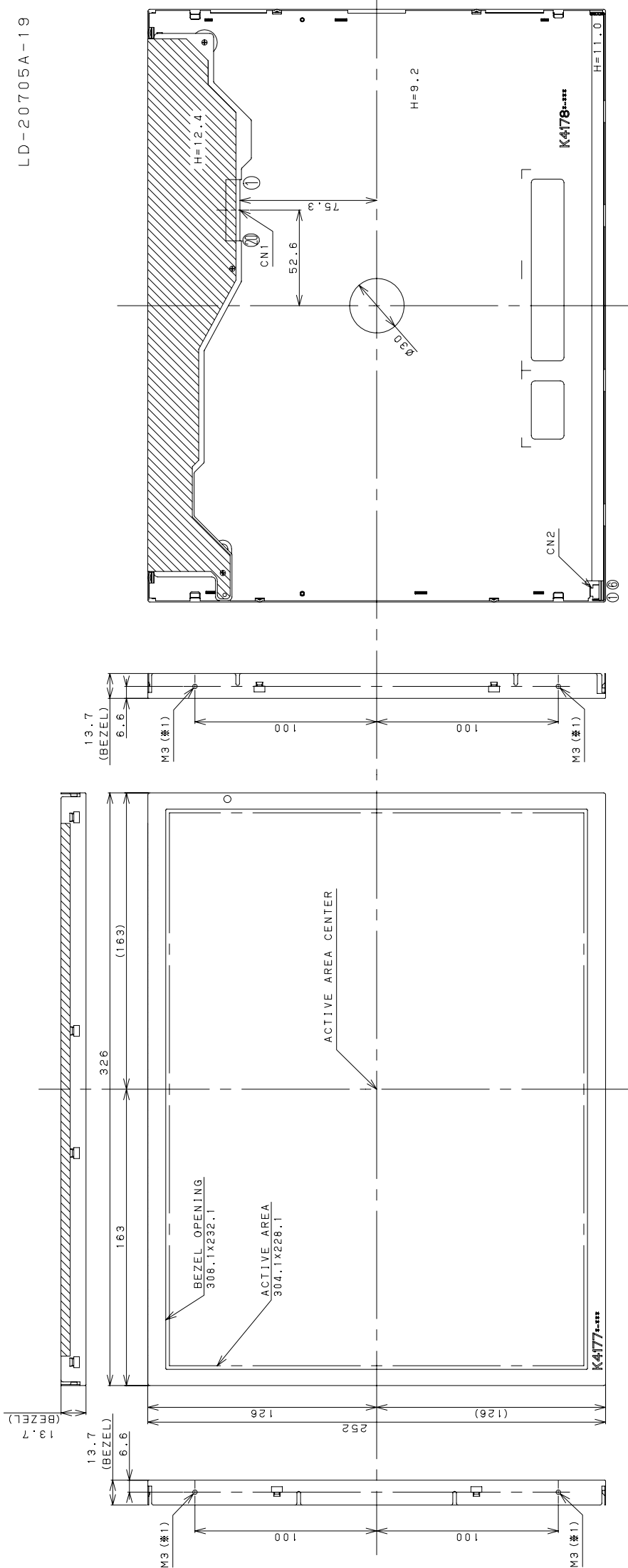

NOTES  
 1. UNSPECIFIED TOLERANCE TO BE  $\pm 0.5$   
 2. WARP AND FLOATING FOR PRINTED WIRING BOARD AND CHASSIS ARE EXCLUDED FROM THE THICKNESS OF THE UNIT  
 (\*1) TIGHTEN TORQUE (RECOMMENDATION)  
 0.34N·m  $\pm 0.02$ N·m  
 (3.5kgf·cm  $\pm 0.2$ kgf·cm)

1) TOLERANCE X-DIRECTION A:  $2.0 \pm 0.8$   
 2) TOLERANCE Y-DIRECTION B:  $2.0 \pm 0.8$   
 3) OBLIQUITY OF DISPLAY AREA IC-DI  $< 0.8$

I / F CONNECTOR

CN1: DF14H-20P-1.25H (HIROSE)

①	Vcc	⑥	RXIN0+	⑩	RXIN2-	⑭	GND
②	Vcc	⑦	GND	⑪	RXIN2+	⑮	RXIN3-
③	GND	⑧	RXIN1-	⑫	GND	⑯	RXIN3+
④	GND	⑨	RXIN1+	⑬	RXCKIN-	⑰	GND
⑤	RXIN0-	⑪	GND	⑭	RXCKIN+	⑱	LVDS-SET

CN2: 50156806 (MOLEX)

①	+ch3	Power supply for LED (Ch3 High voltage side)
②	+ch2	Power supply for LED (Ch2 High voltage side)
③	+ch1	Power supply for LED (Ch1 High voltage side)
④	-ch1	Power supply for LED (Ch1 Low voltage side)
⑤	-ch2	Power supply for LED (Ch2 Low voltage side)
⑥	-ch3	Power supply for LED (Ch3 Low voltage side)

Fig. 1 LQ150X1LG82 OUTLINE DIMENSIONS

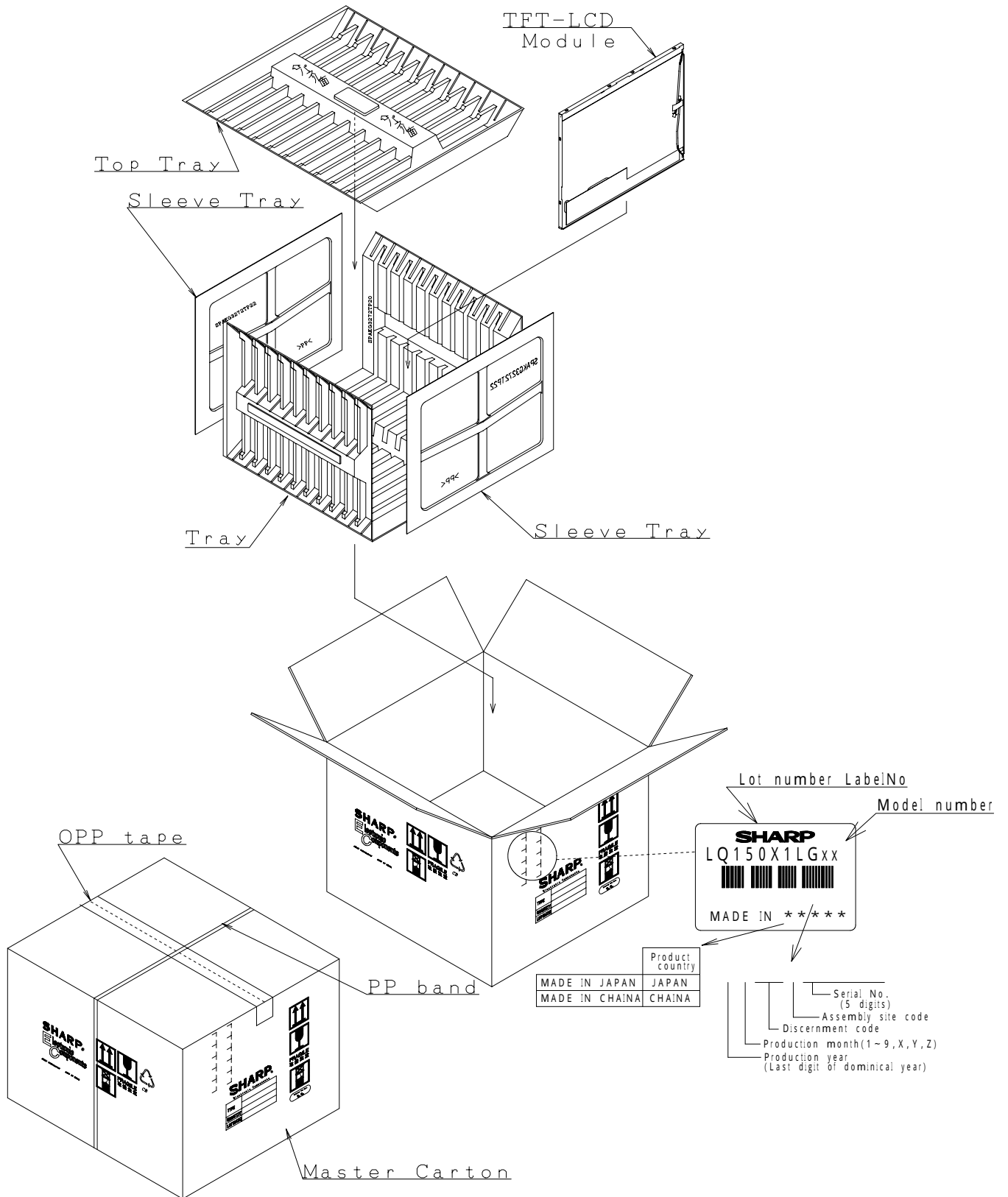

Fig3. Packing Form

# LCD Specification

## LCD Group



### NORTH AMERICA

Sharp Microelectronics of the Americas  
5700 NW Pacific Rim Blvd.  
Camas, WA 98607, U.S.A.  
Phone: (1) 360-834-2500  
Fax: (1) 360-834-8903  
www.sharpsma.com

### TAIWAN

Sharp Electronic Components  
(Taiwan) Corporation  
8F-A, No. 16, Sec. 4, Nanking E. Rd.  
Taipei, Taiwan, Republic of China  
Phone: (886) 2-2577-7341  
Fax: (886) 2-2577-7326/2-2577-7328

### CHINA

Sharp Microelectronics of China  
(Shanghai) Co., Ltd.  
28 Xin Jin Qiao Road King Tower 16F  
Pudong Shanghai, 201206 P.R. China  
Phone: (86) 21-5854-7710/21-5834-6056  
Fax: (86) 21-5854-4340/21-5834-6057  
Head Office:  
No. 360, Bashen Road,  
Xin Development Bldg. 22  
Waigaoqiao Free Trade Zone Shanghai  
200131 P.R. China  
Email: smc@china.global.sharp.co.jp

### EUROPE

Sharp Microelectronics Europe  
Division of Sharp Electronics (Europe) GmbH  
Sonninstrasse 3  
20097 Hamburg, Germany  
Phone: (49) 40-2376-2286  
Fax: (49) 40-2376-2232  
www.sharpsme.com

### SINGAPORE

Sharp Electronics (Singapore) PTE., Ltd.  
438A, Alexandra Road, #05-01/02  
Alexandra Technopark,  
Singapore 119967  
Phone: (65) 271-3566  
Fax: (65) 271-3855

### KOREA

Sharp Electronic Components  
(Korea) Corporation  
RM 501 Geosung B/D, 541  
Dohwa-dong, Mapo-ku  
Seoul 121-701, Korea  
Phone: (82) 2-711-5813 ~ 8  
Fax: (82) 2-711-5819

### JAPAN

Sharp Corporation  
Electronic Components & Devices  
22-22 Nagaïke-cho, Abeno-Ku  
Osaka 545-8522, Japan  
Phone: (81) 6-6621-1221  
Fax: (81) 6117-725300/6117-725301  
www.sharp-world.com

### HONG KONG

Sharp-Roxy (Hong Kong) Ltd.  
3rd Business Division,  
17/F, Admiralty Centre, Tower 1  
18 Harcourt Road, Hong Kong  
Phone: (852) 28229311  
Fax: (852) 28660779  
www.sharp.com.hk  
Shenzhen Representative Office:  
Room 13B1, Tower C,  
Electronics Science & Technology Building  
Shen Nan Zhong Road  
Shenzhen, P.R. China  
Phone: (86) 755-3273731  
Fax: (86) 755-3273735

SPECIFICATIONS ARE SUBJECT TO CHANGE WITHOUT NOTICE.

Suggested applications (if any) are for standard use; See Important Restrictions for limitations on special applications. See Limited Warranty for SHARP's product warranty.

The Limited Warranty is in lieu, and exclusive of, all other warranties, express or implied.

ALL EXPRESS AND IMPLIED WARRANTIES, INCLUDING THE WARRANTIES OF MERCHANTABILITY, FITNESS FOR USE AND FITNESS FOR A PARTICULAR PURPOSE, ARE SPECIFICALLY EXCLUDED. In no event will SHARP be liable, or responsible in any way, for any incidental or consequential economic or property damage.