

Description

RailClamp® TVS arrays are ultra low capacitance ESD protection devices designed to protect high speed data interfaces. This series has been specifically designed to protect sensitive components which are connected to high-speed data and transmission lines from overvoltage caused by ESD (electrostatic discharge), CDE (Cable Discharge Events), and EFT (electrical fast transients).

The monolithic design incorporates surge rated, low capacitance steering diodes and a TVS diode in a single package. Each line has a typical capacitance of <math><0.2\text{pF}</math> to ground. The capacitance of each line is well matched for constant signal balance. A connection to the TVS is provided for protection of external voltage buses, such as those found in USB applications. They may be used to meet the ESD immunity requirements of IEC 61000-4-2, Level 4 ($\pm 15\text{kV}$ air, $\pm 8\text{kV}$ contact discharge).

The RClamp®0582N is qualified to AEC-Q100 Grade1 (-40 to +125°C) and is supplied in a 6-pin SLP1210N6 package. It measures 1.2 x 1.0 x 0.58mm.

Features

- ◆ ESD protection for high-speed data lines to **IEC 61000-4-2 (ESD) $\pm 20\text{kV}$ (air), $\pm 12\text{kV}$ (contact)** **IEC 61000-4-4 (EFT) 40A (5/50ns)**
- ◆ Qualified to AEC-Q100 Grade1 (-40 to +125°C)
- ◆ Array of surge rated diodes with internal TVS Diode
- ◆ Small package saves board space
- ◆ Protects two I/O lines and a power line
- ◆ Low capacitance: 0.2pF typical
- ◆ Low clamping voltage
- ◆ Solid-state silicon-avalanche technology

Mechanical Characteristics

- ◆ SLP1210N6 Package
- ◆ Pb-Free, Halogen Free, RoHS/WEEE Compliant
- ◆ Nominal Dimensions: 1.2 x 1.0 x 0.58 mm
- ◆ Lead Pitch: 0.4mm
- ◆ Lead Finish: NiPdAu
- ◆ Marking : Marking Code
- ◆ Packaging : Tape and Reel

Applications

- ◆ Automobile USB
- ◆ MMC/SD Port
- ◆ Automobile Video Ports

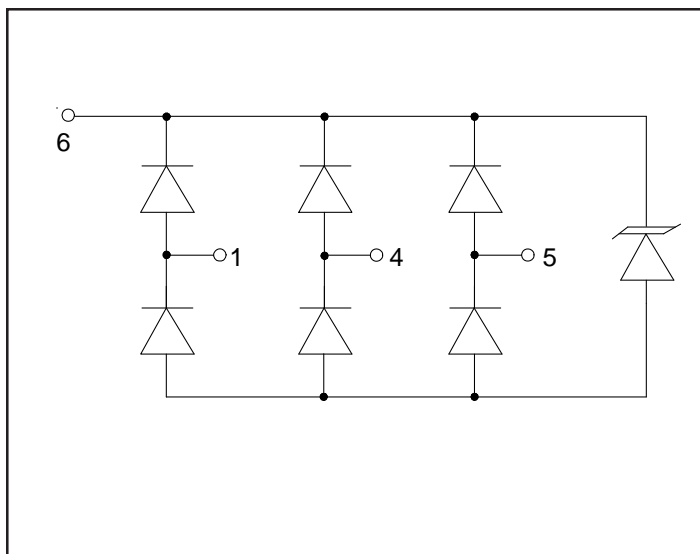
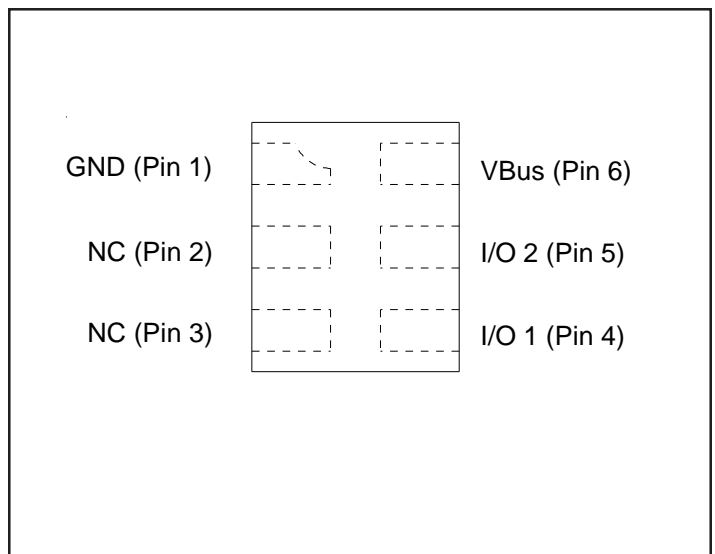
Circuit Diagram

Pin Configuration

PROTECTION PRODUCTS
Absolute Maximum Ratings

Rating	Symbol	Value	Units
Peak Pulse Power (tp = 8/20μs)	P_{pk}	125	Watts
Peak Pulse Current (tp = 8/20μs)	I_{pp}	5	A
ESD per IEC 61000-4-2 (Air) ESD per IEC 61000-4-2 (Contact)	V_{ESD}	±20 ±12	kV
Operating Temperature	T_J	-55 to +125	°C
Storage Temperature	T_{STG}	-55 to +150	°C

Electrical Characteristics (T=25°C unless otherwise specified)

Parameter	Symbol	Conditions	Minimum	Typical	Maximum	Units	
Reverse Stand-Off Voltage	V_{RWM}	Pin 6 to GND			6.5	V	
Reverse Breakdown Voltage	V_{BR}	$I_t = 1mA$; Pin 6 to GND T=-40 °C to 125 °C	7	9.5	12	V	
Reverse Leakage Current	I_R	$V_{RWM} = 6.5V$, Pin 6 to GND	T=25 °C		0.005	0.100	μA
			T=125 °C			0.200	uA
Clamping Voltage	V_C	$I_{pp} = 1A$, tp = 8/20μs Any I/O pin to Ground			15	V	
Clamping Voltage	V_C	$I_{pp} = 5A$, tp = 8/20μs Any I/O pin to Ground			25	V	
Junction Capacitance	C_j	$V_R = 0V$, f = 1MHz Any I/O pin to Ground		0.2	0.5	pF	
		$V_R = 0V$, f = 1MHz Between I/O pins		0.2	0.5	pF	

Non-Repetitive Peak Pulse Power vs. Pulse Time

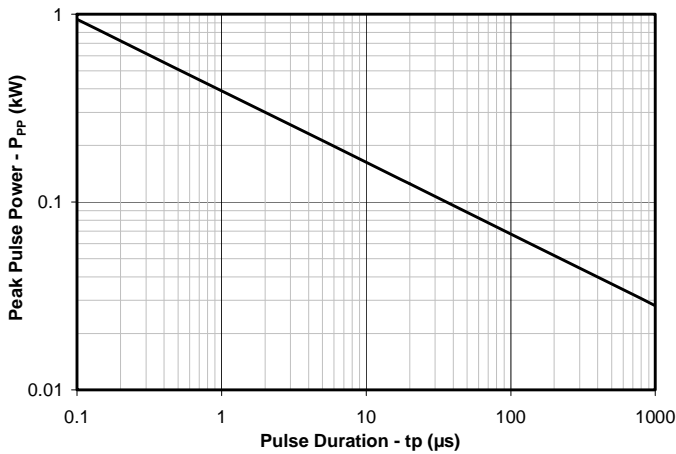

Power Derating Curve

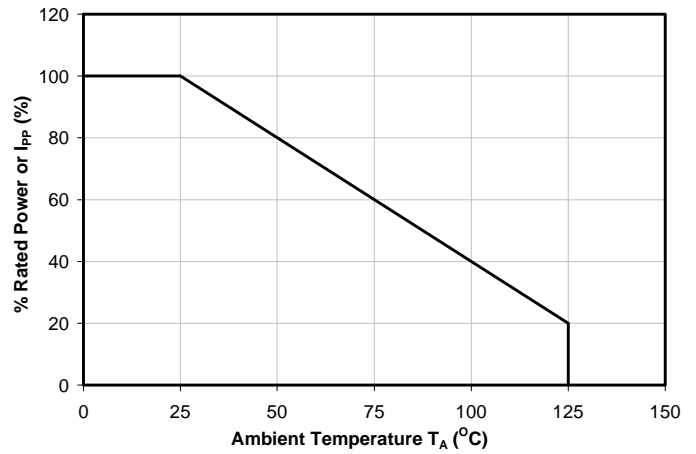

Clamping Voltage vs. Peak Pulse Current I/O to Gnd - Pin 4, 5 to Pin 1

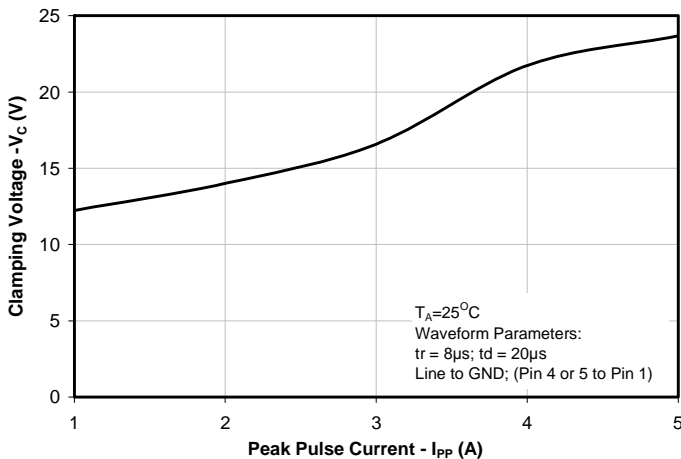

Normalize Capacitance vs. Reverse Voltage I/O to Gnd - Pin 4, 5 to Pin 1

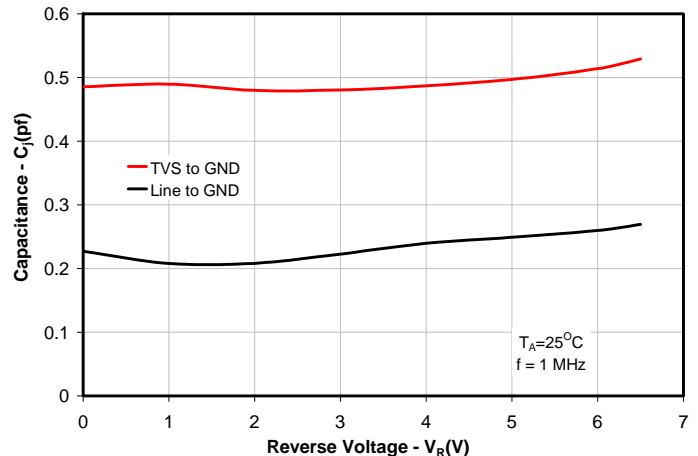

ESD Clamping (Contact per IEC 61000-4-2)

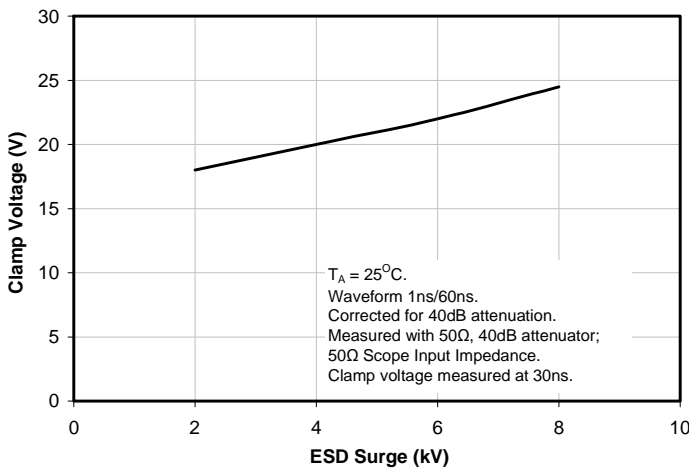

Insertion Loss

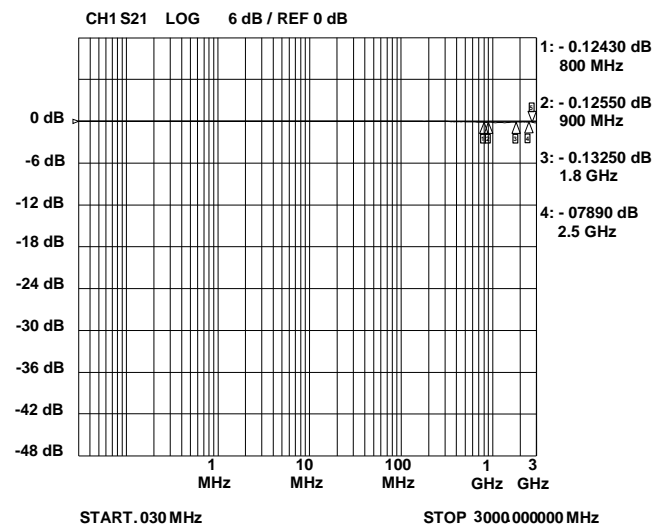

Capacitance v Temperature

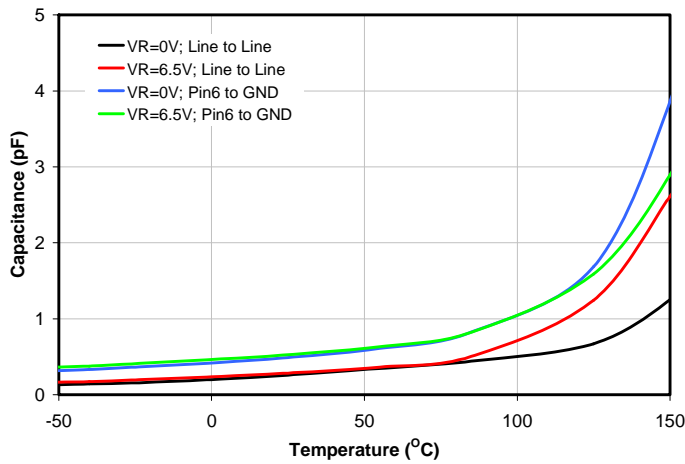

VF v Temperature

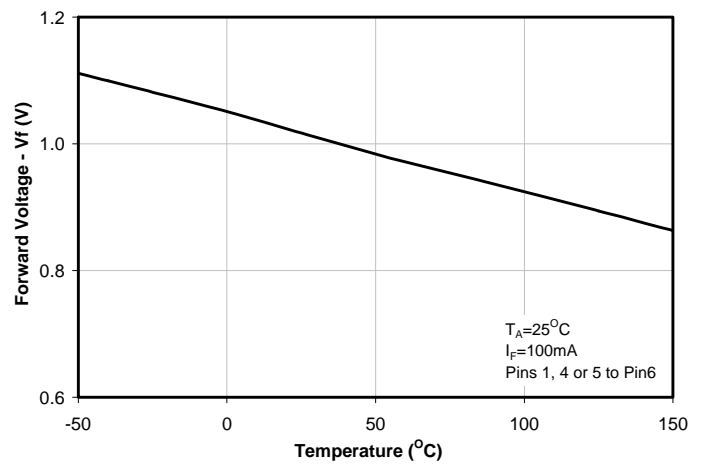

Breakdown Voltage v Temperature

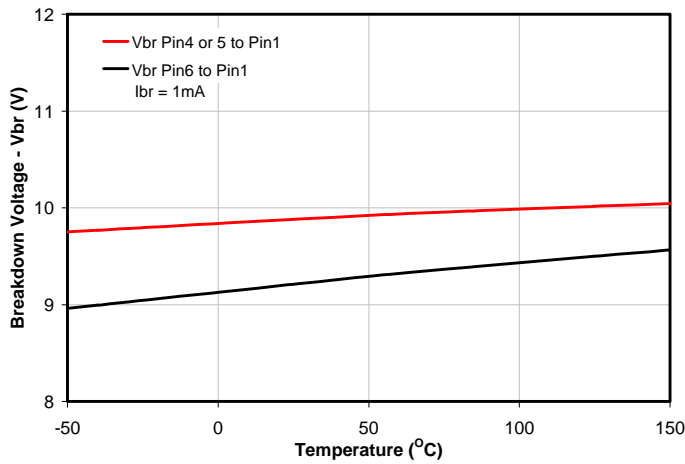

Leakage Current v Temperature

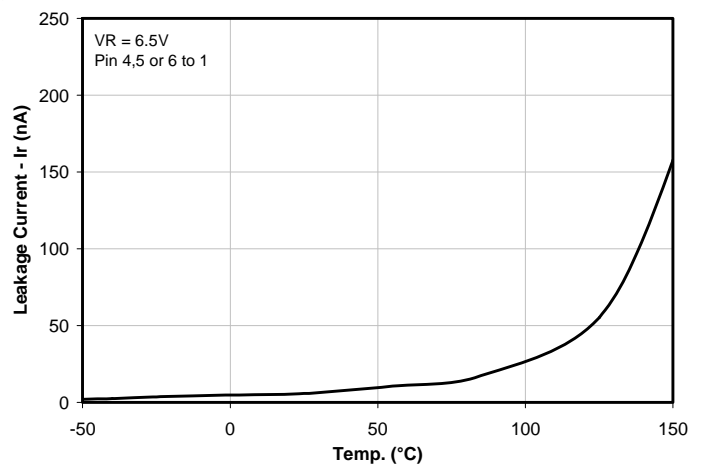

Crosstalk Pin 4 to Pin 5



Device Connection Options for Protection of Two High-Speed Data Lines

Data line inputs are normally connected at pins 4 & 5 with the outputs connected at pins 2 & 3. Pin 1 is connected to ground. Note that the circuit at the ground pin is identical to the circuit at each data input/output pin. This is done to further reduce capacitance. The connection to ground should be made directly to a ground plane. The path length should also be kept as short as possible to minimize parasitic inductance. Pin 6 can be connected to Vcc biased or left not connected depending upon the application.

Figure 1- Pin Configuration & Circuit Diagram

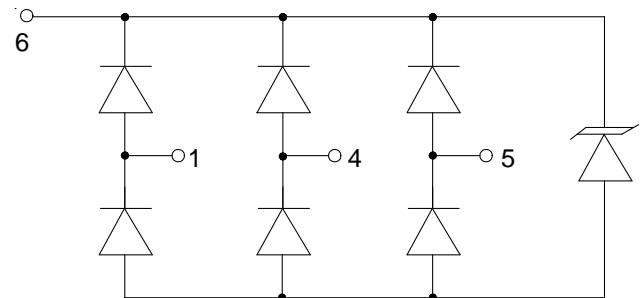

Protecting USB 2.0 Interfaces

The USB interface consists of Data (D- and D+) lines and a 5.25V voltage bus. Since these pins are part of the connector, they are vulnerable to ESD and cable discharge events. The RClamp0582NQ is designed to protect all four USB connections (VCC, D-, D+, and Gnd). Each device will protect one USB port. When the voltage on the data lines exceed the bus voltage (plus one diode drop), the internal rectifiers are forward biased conducting the transient current away from the protected controller chip. The TVS diode directs the surge to ground. The TVS diode also acts to suppress ESD strikes directly on the voltage bus. Thus, both power and data pins are protected with a single device.

Figure 2 - USB 2.0 High Speed Protection

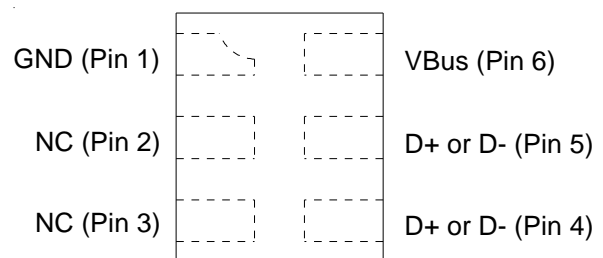

USB Controller

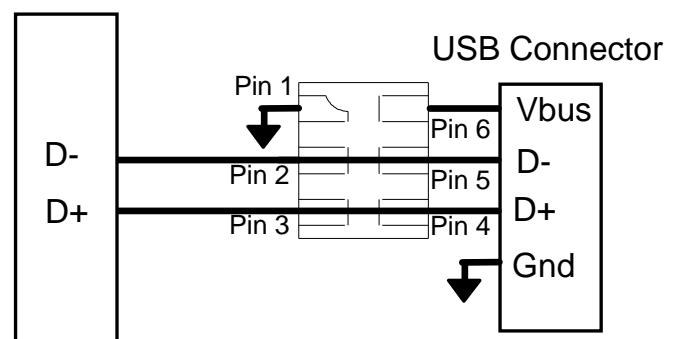

PROTECTION PRODUCTS

Outline Drawing - SLP1210N6

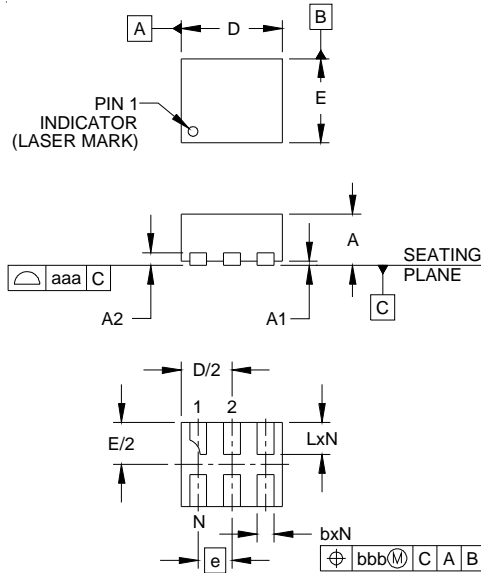

DIM	INCHES			MILLIMETERS		
	MIN	NOM	MAX	MIN	NOM	MAX
A	.020	.023	.026	0.50	0.58	0.65
A1	0.00	.001	.002	0.00	0.03	0.05
A2		(.005)			(0.13)	
b	.006	.008	.010	0.15	0.20	0.25
D	.043	.047	.051	1.10	1.20	1.30
E	.035	.039	.043	0.90	1.00	1.10
e		.016 BSC			0.40 BSC	
L	.012	.015	.017	0.30	0.38	0.425
N		6			6	
aaa		.003			0.08	
bbb		.004			0.10	

NOTES:
1. CONTROLLING DIMENSIONS ARE IN MILLIMETERS (ANGLES IN DEGREES).

Land Pattern - SLP1210N6

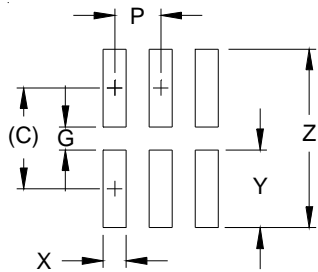

DIM	DIMENSIONS	
	INCHES	MILLIMETERS
C	(.034)	(0.875)
G	.008	0.20
P	.016	0.40
X	.008	0.20
Y	.027	0.675
Z	.061	1.55

NOTES:
1. CONTROLLING DIMENSIONS ARE IN MILLIMETERS (ANGLES IN DEGREES).
2. THIS LAND PATTERN IS FOR REFERENCE PURPOSES ONLY. CONSULT YOUR MANUFACTURING GROUP TO ENSURE YOUR COMPANY'S MANUFACTURING GUIDELINES ARE MET.

PROTECTION PRODUCTS

Marking Codes

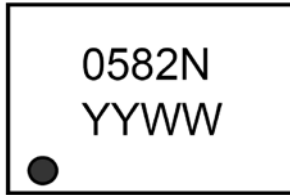

YYWW = Date Code

Ordering Information

Part Number	Qty per Reel	Reel Size
RClamp0582N.TCT	3,000	7 Inch

RailClamp and RClamp are marks of Semtech Corporation

Tape and Reel Specification

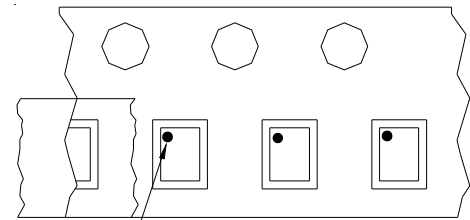
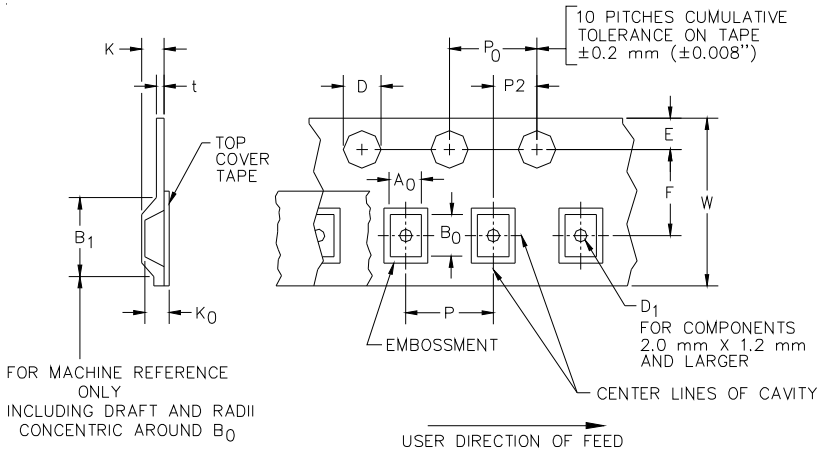

Pin 1 Location

→ User Direction of feed

Device Orientation in Tape

A0	B0	K0
1.21 ±0.10 mm	1.41 ±0.10 mm	0.74 ±0.10 mm

Tape Width	B, (Max)	D	D1	E	F	K (MAX)	P	P0	P2	T(MAX)	W
8 mm	4.2 mm (.165)	1.5 + 0.1 mm - 0.0 mm (0.59 +.005 - .000)	0.8 mm ±0.05 (.031)	1.750±.10 mm (.069±.004)	3.5±0.05 mm (.138±.002)	2.4 mm (.094)	4.0±0.1 mm (.157±.00-4)	4.0±0.1 mm (.157±.00-4)	2.0±0.05mm (.079±.002)	0.4 mm (.016)	8.0 mm + 0.3 mm - 0.1 mm (.312±.012-)

Contact Information

Semtech Corporation
 Protection Products Division
 200 Flynn Road, Camarillo, CA 93012
 Phone: (805)498-2111 FAX (805)498-3804