

SKT 55



Stud Thyristor

Line Thyristor

SKT 55

Features

- Hermetic metal case with glass insulator
- Threaded stud ISO M12
- International standard case

Typical Applications*

- DC motor control (e. g. for machines tools)
- Controlled rectifiers (e. g. for battery charging)
- AC controllers (e. g. for temperature control)
- Recommended snubber network e. g. for $V_{VRMS} \leq 400$ V:
 $R = 47 \Omega / 10$ W, $C = 0,22 \mu F$

V_{RSM} V	V_{RRM}, V_{DRM} V	$I_{TRMS} = 110$ A (maximum value for continuous operation) $I_{TAV} = 55$ A (sin. 180; $T_c = 92$ °C)	
500	400	SKT 55/04D	
700	600	SKT 55/06D	
900	800	SKT 55/08D	
1300	1200	SKT 55/12E	
1500	1400	SKT 55/14E	
1700	1600	SKT 55/16E	
1900	1800	SKT 55/18E	

Symbol	Conditions	Values	Units
I_{TAV}	sin. 180; $T_c = 100$ (85) °C;	47 (63)	A
I_D	K3; $T_a = 45$ °C; B2 / B6	42 / 60	A
	K1,1; $T_a = 45$ °C; B2 / B6	76 / 110	A
I_{RMS}	K3; $T_a = 45$ °C; W1C	46	A
I_{TSM}	$T_{vj} = 25$ °C; 10 ms	1300	A
	$T_{vj} = 130$ °C; 10 ms	1100	A
i^2t	$T_{vj} = 25$ °C; 8,35 ... 10 ms	8500	A ² s
	$T_{vj} = 130$ °C; 8,35 ... 10 ms	6000	A ² s
V_T	$T_{vj} = 25$ °C; $I_T = 200$ A	max. 1,8	V
$V_{T(TO)}$	$T_{vj} = 130$ °C	max. 0,9	V
r_T	$T_{vj} = 130$ °C	max. 4	mΩ
I_{DD}, I_{RD}	$T_{vj} = 130$ °C; $V_{RD} = V_{RRM}, V_{DD} = V_{DRM}$	max. 25	mA
t_{gd}	$T_{vj} = 25$ °C; $I_G = 1$ A; $di_G/dt = 1$ A/μs	1	μs
t_{gr}	$V_D = 0,67 * V_{DRM}$	2	μs
$(di/dt)_{cr}$	$T_{vj} = 130$ °C	max. 50	A/μs
$(dv/dt)_{cr}$	$T_{vj} = 130$ °C; SKT ...D / SKT ...E	max. 500 / 1000	V/μs
t_q	$T_{vj} = 130$ °C,	100	μs
I_H	$T_{vj} = 25$ °C; typ. / max.	150 / 250	mA
I_L	$T_{vj} = 25$ °C; typ. / max.	300 / 600	mA
V_{GT}	$T_{vj} = 25$ °C; d.c.	min. 3	V
I_{GT}	$T_{vj} = 25$ °C; d.c.	min. 150	mA
V_{GD}	$T_{vj} = 130$ °C; d.c.	max. 0,25	V
I_{GD}	$T_{vj} = 130$ °C; d.c.	max. 10	mA
$R_{th(j-c)}$	cont.	0,4	K/W
$R_{th(j-c)}$	sin. 180	0,47	K/W
$R_{th(j-c)}$	rec. 120	0,53	K/W
$R_{th(c-s)}$		0,08	K/W
T_{vj}		- 40 ... + 130	°C
T_{stg}		- 55 ... + 150	°C
V_{isol}		-	V~
M_s	to heatsink	10	Nm
a		5 * 9,81	m/s ²
m	approx.	100	g
Case		B 5	

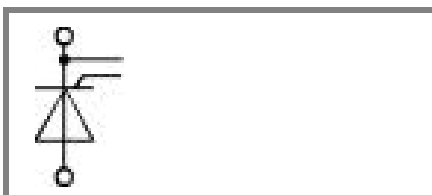

SKT

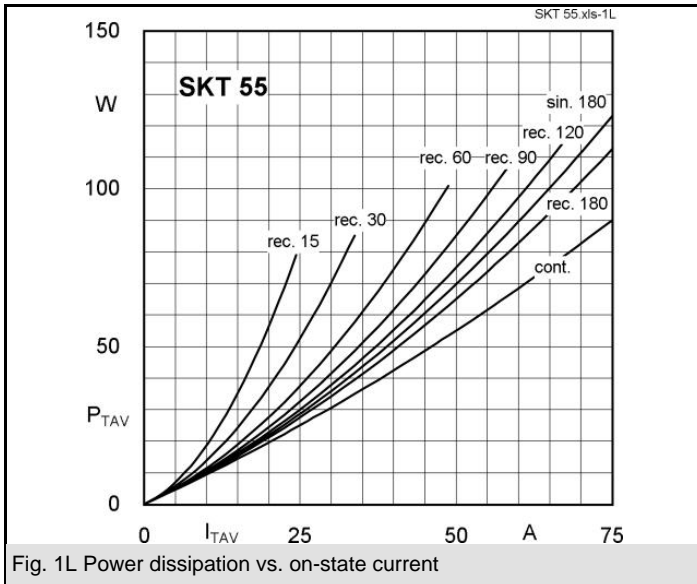

Fig. 1L Power dissipation vs. on-state current

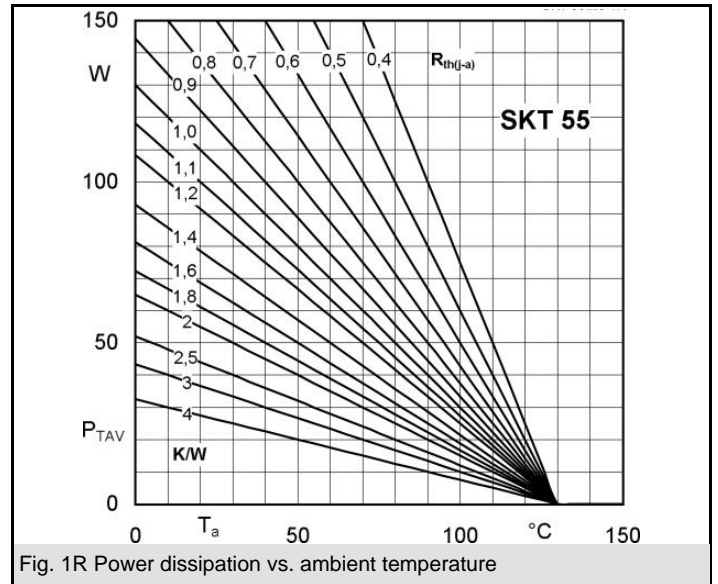

Fig. 1R Power dissipation vs. ambient temperature

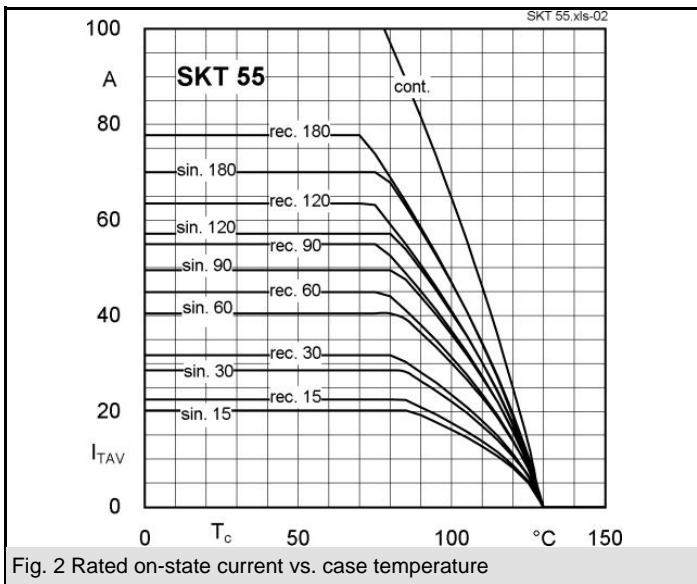

Fig. 2 Rated on-state current vs. case temperature

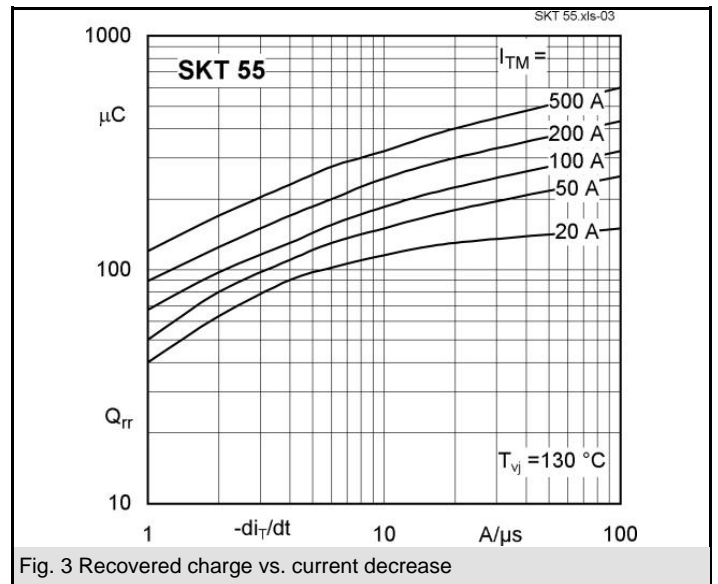

Fig. 3 Recovered charge vs. current decrease

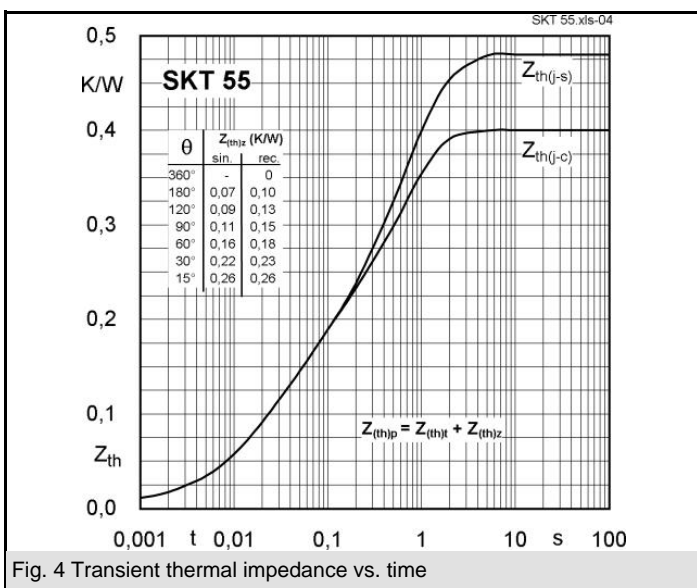

Fig. 4 Transient thermal impedance vs. time

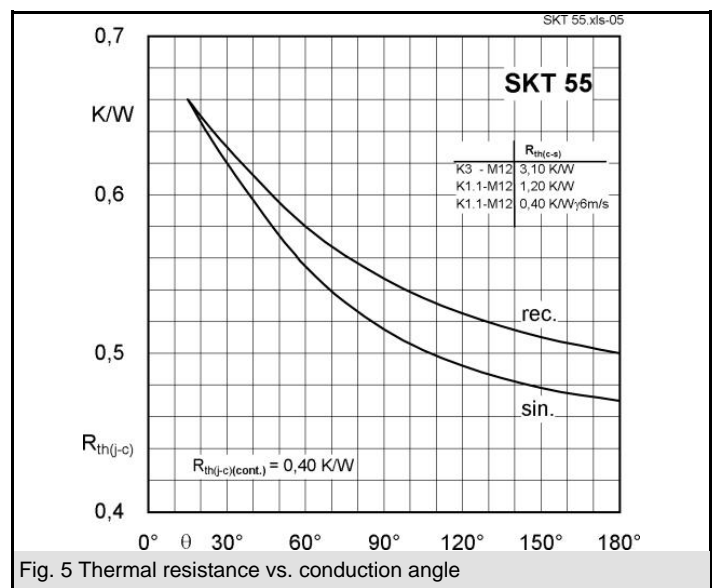
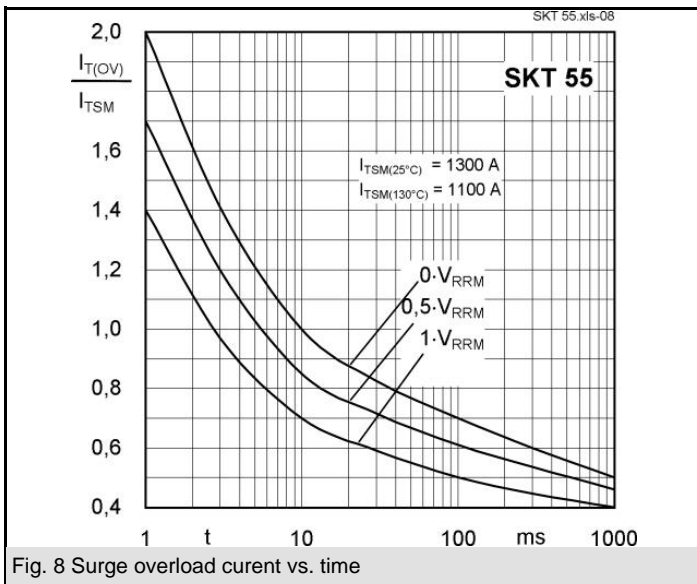
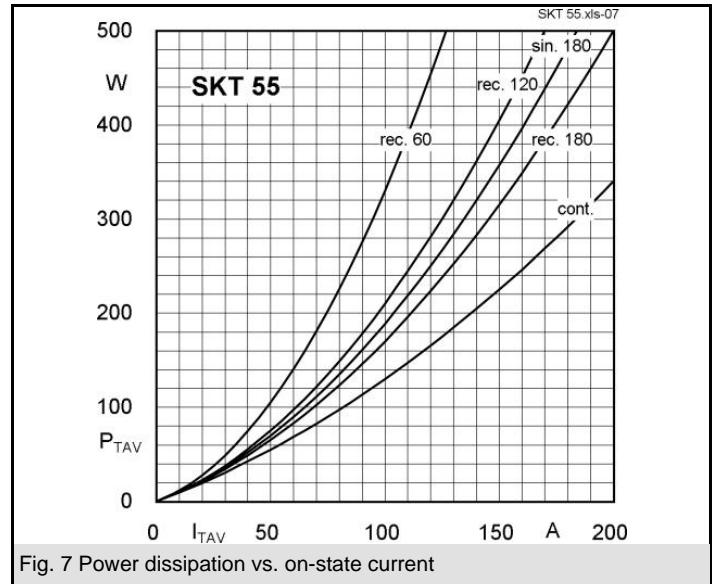
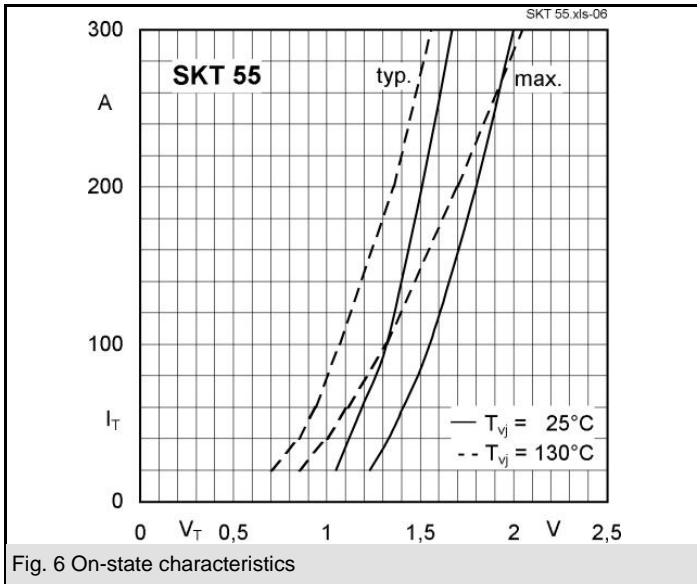
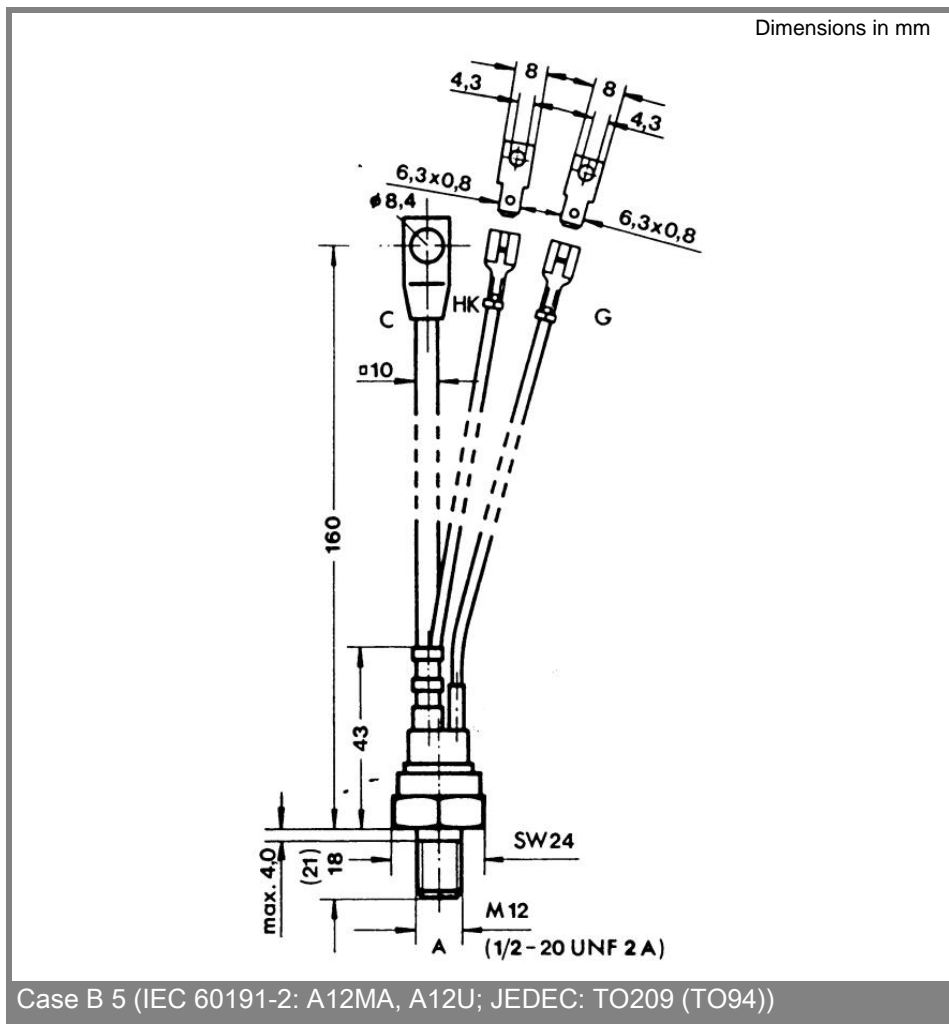
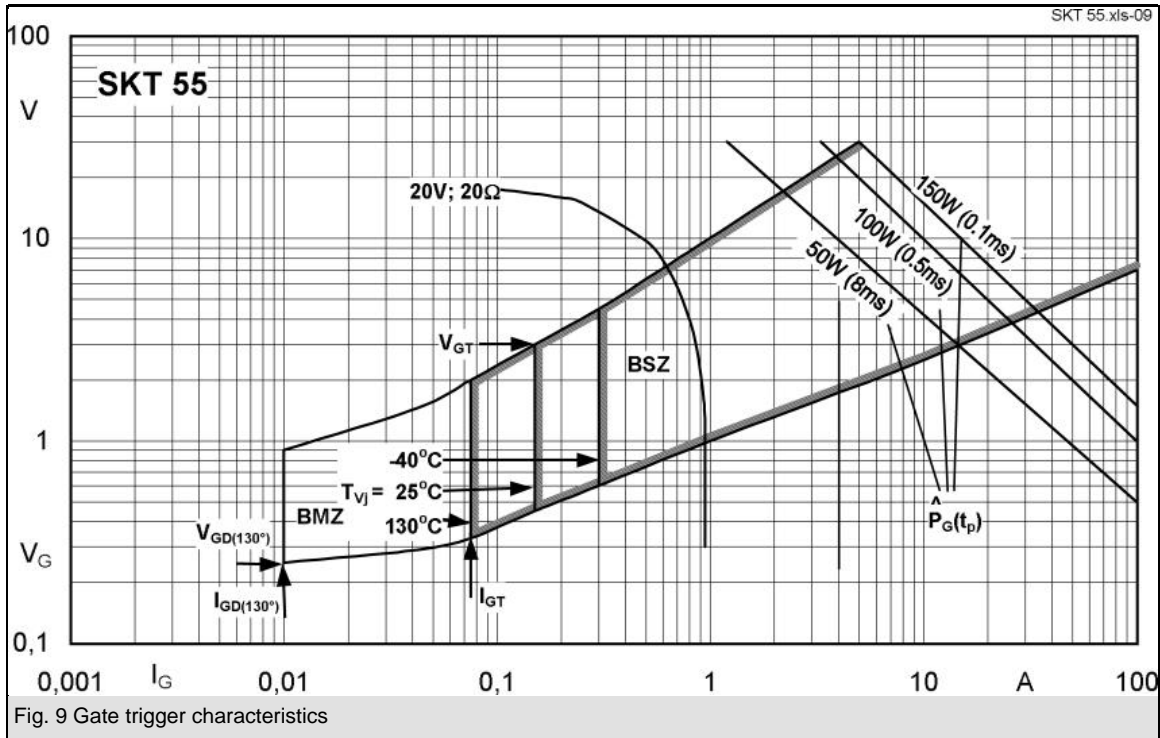

Fig. 5 Thermal resistance vs. conduction angle





* The specifications of our components may not be considered as an assurance of component characteristics. Components have to be tested for the respective application. Adjustments may be necessary. The use of SEMIKRON

products in life support appliances and systems is subject to prior specification and written approval by SEMIKRON. We therefore strongly recommend prior consultation of our personal.