

Stud Diode

Avalanche Diode

SKNa 2

Features

- Avalanche type reverse characteristic up to 1700V
- Transient voltage proof within specified limits
- Hermetic metal case with glass insulator
- Anode side threaded stud ISO M4 with lead wire in addition
- SKN: Anode to stud

Typical Applications*

- DC supply for magnetes or solenoids (brakes, valves etc.)
- Field coil supply for DC motors
- Series connections for high voltage applications (dust precipitators)

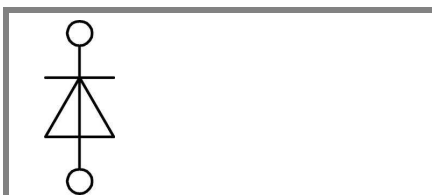

SKN

$V_{(BR)min}$	$I_{FRMS} = 5 \text{ A}$ (maximum value for continuous operation)	C_{max}	R_{min}
V	$I_{FAV} = 2 \text{ A}$ (sin. 180; $T_a = 45 \text{ °C}$)	μF	Ω
1300	SKNa 2/13		
1700	SKNa 2/17		

Symbol	Conditions	Values	Units
I_{FAV}	sin. 180; $T_a = 45 \text{ (85) °C}$	2 (1,25)	A
I_{FAV}	rec. 120; $T_a = 45 \text{ °C}$	1,9	A
I_{FSM}	$T_{vj} = 25 \text{ °C}$; 10 ms	180	A
	$T_{vj} = 150 \text{ °C}$; 10 ms	150	A
i^2t	$T_{vj} = 25 \text{ °C}$; 8,3 ... 10 ms	160	A ² s
	$T_{vj} = 150 \text{ °C}$; 8,3 ... 10 ms	110	A ² s
V_F	$T_{vj} = 25 \text{ °C}$; $I_F = 10 \text{ A}$	max. 1,2	V
$V_{(TO)}$	$T_{vj} = 150 \text{ °C}$	max. 0,85	V
r_T	$T_{vj} = 150 \text{ °C}$	max. 30	m Ω
I_{RD}	$T_{vj} = 150 \text{ °C}$; $V_{RD} = V_{(BR)min}$	max. 600	μA
P_{RSM}	$T_{vj} = 150 \text{ °C}$; $t_p = 10 \mu\text{s}$	3	kW
$R_{th(j-c)}$		2,5	K/W
$R_{th(j-a)}$		55	K/W
T_{vj}		- 40 ... + 150	$^{\circ}\text{C}$
T_{stg}		- 40 ... + 180	$^{\circ}\text{C}$
V_{isol}		-	V~
M_s		0,8	Nm
a		5 * 9,81	m/s ²
m	approx.	6	g
Case		E 5	

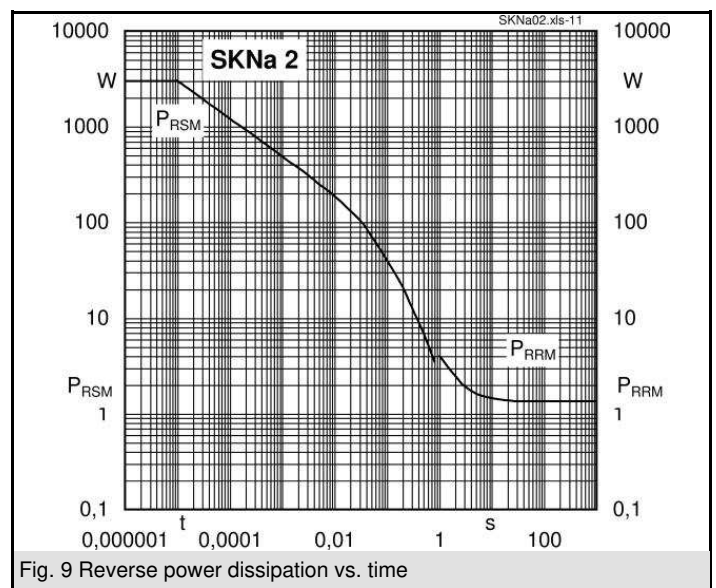
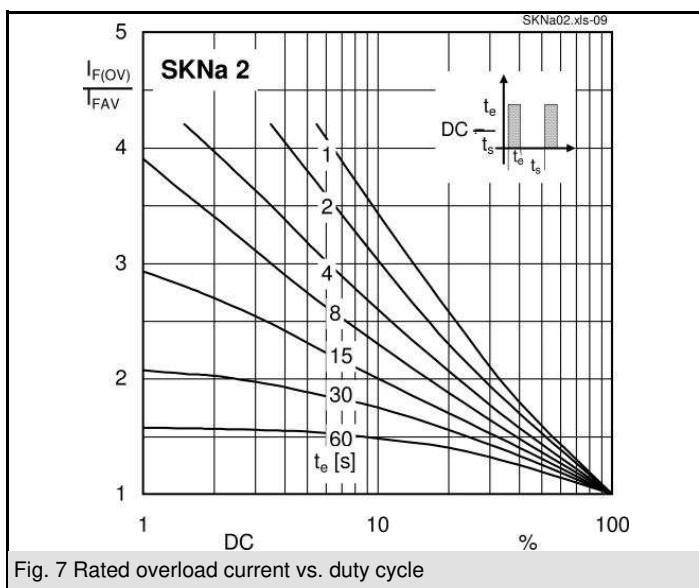
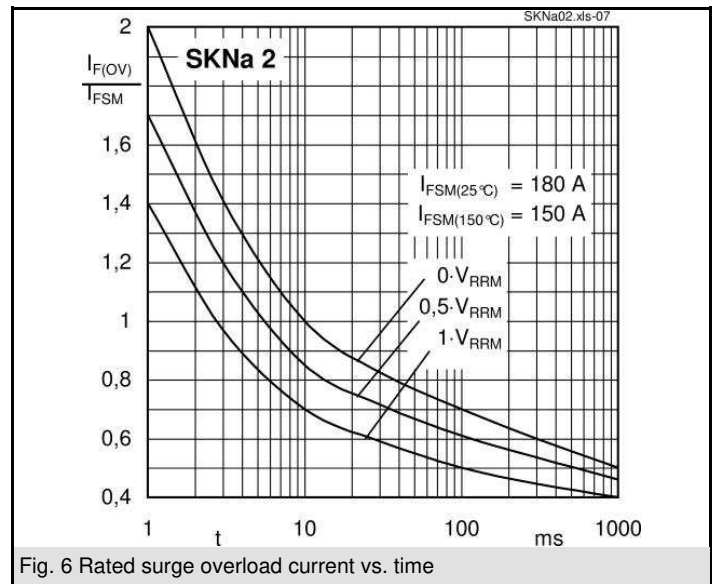
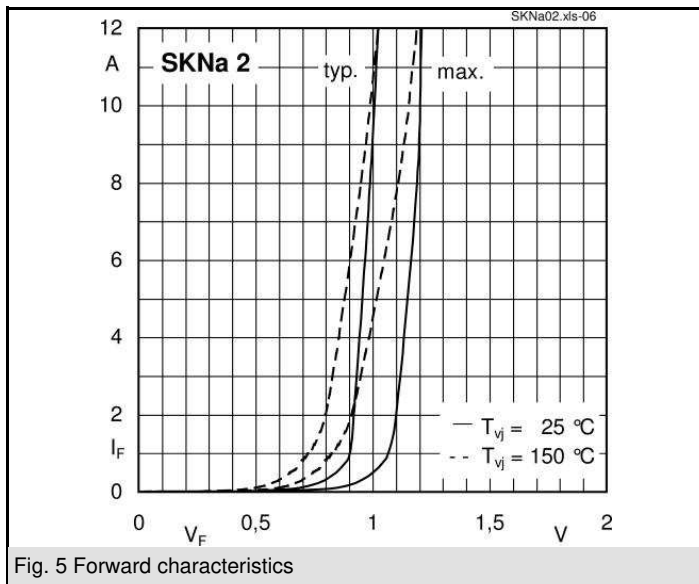
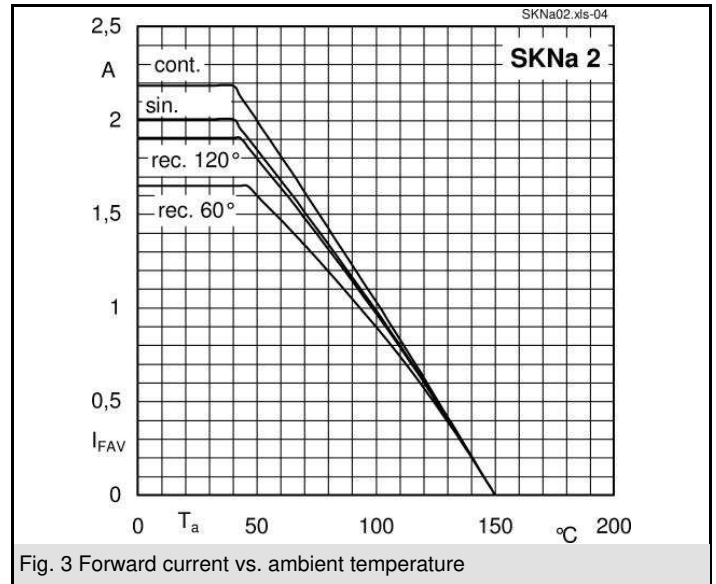
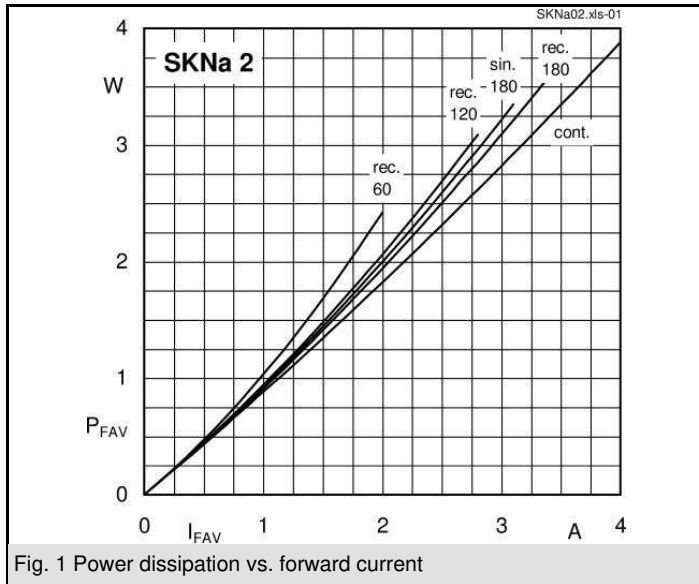

Dimensions in mm

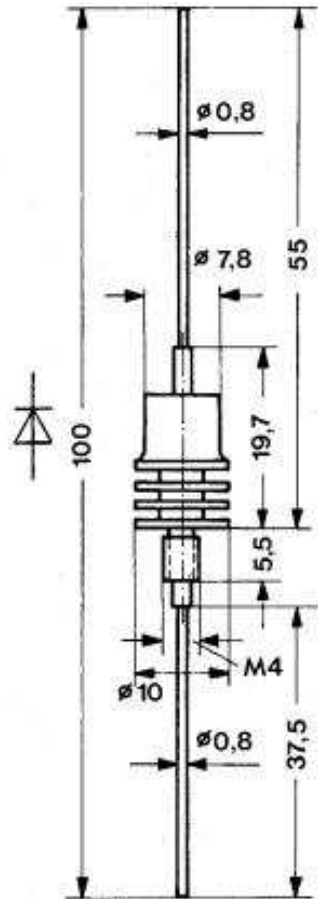

CASE E 5 (IEC 60191: A 2 modified; JEDEC: DO-1 modified)

* The specifications of our components may not be considered as an assurance of component characteristics. Components have to be tested for the respective application. Adjustments may be necessary. The use of SEMIKRON products in life support appliances and systems is subject to prior specification and written approval by SEMIKRON. We therefore strongly recommend prior consultation of our personal.