

## Grove - Differential Amplifier v1.2

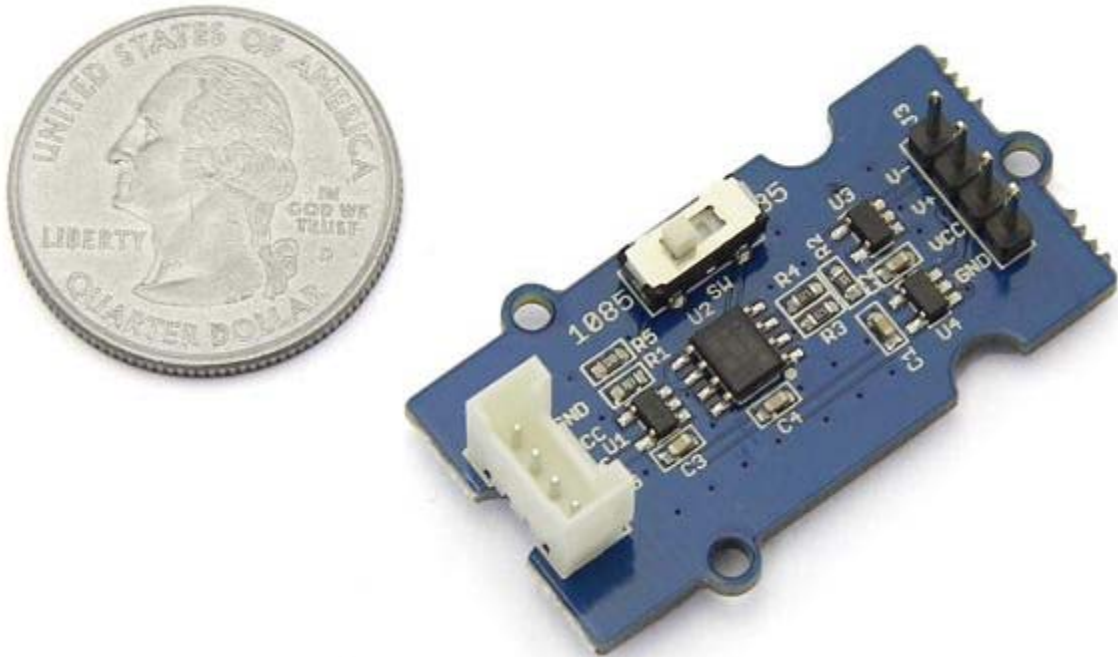

This Grove is designed for precise differential-input amplification. Input the differential signals of your sensor to this module through the male pins, then your Arduino will get a precisely amplified output from the Grove interface. The gain scale factor is selectable. You can get a 35 times or 1085 times amplification via a switch on the board.

### Features

- High amplifying precision
- Selectable scale factor
- Can be conveniently read by Arduino

### Tip

More details about Grove modules please refer to [Grove System](#)





## Applications

- Data acquisition
- Battery operated systems
- Pressure and temperature bridge amplifiers
- General purpose instrumentation

## Specifications

Item	Min	Typical	Max	Unit
Operating Voltage	2.7	5.0	5.5	VDC
Input Voltage	0.1	\\	$(V_{cc}-0.8)/Gain$	mV
Output Voltage	0	\\	$V_{cc}-0.80$	mV
Gain	Select 35	/	35	/
	Select 1085	/	1085	/

## Platforms Supported

Arduino	Raspberry Pi	BeagleBone	Wio	LinkIt ONE
				

### Caution

The platforms mentioned above as supported is/are an indication of the module's software or theoretical compatibility. We only provide software library or code examples for Arduino platform in most cases. It is not possible to provide software library / demo code for all possible MCU platforms. Hence, users have to write their own software library.

## Usage

### 1. Sensor Choosing

The amplifier can turn signals in mA scale up to A scale. Before using it, make sure the output range of your sensor is in mA scale. For example, [Weight Sensor](#) is one of them.

### 2. Connector Reforming

To pair the weight sensor up with the male pins on the amplifier, female connectors need to be soldered on its wires.

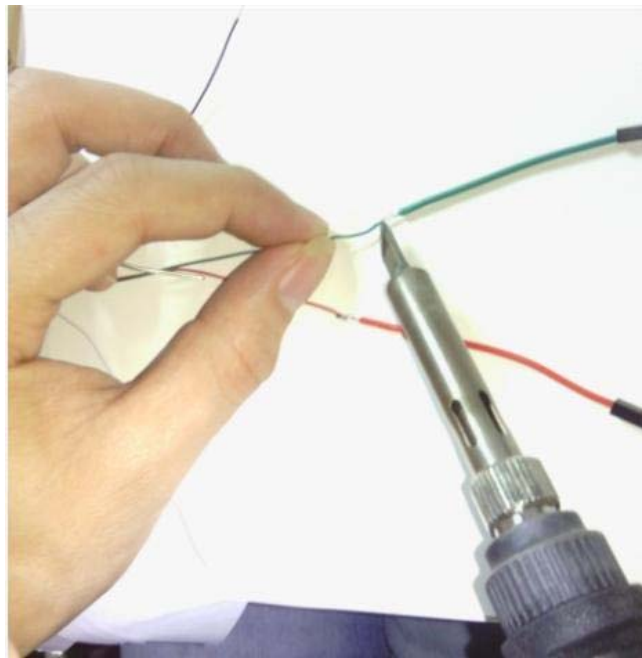

### 3. Hardware Hookup

Connect the weight sensor to the amplifier as the picture depicts below.

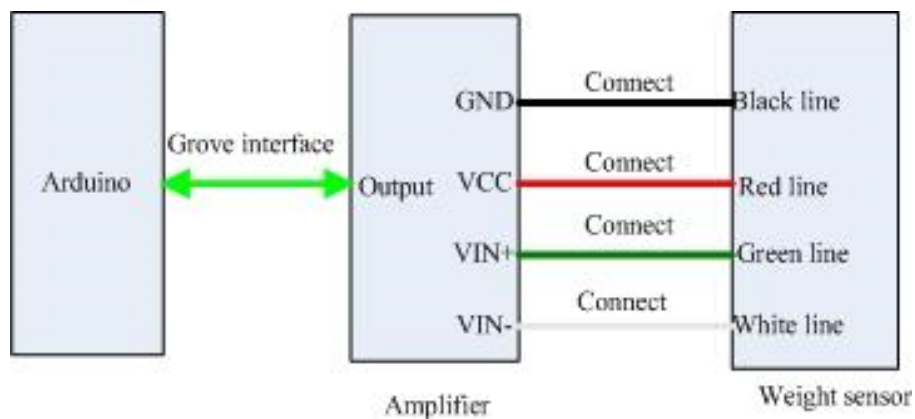

## 4. Measurement

Copy and paste the demo code below to Arduino IDE and upload it.

```
1 void setup()
2 {
3   Serial.begin(9600);
4   Serial.println("start");
5 }
6
7 void loop()
8 {
9   int i;
10  int value;
11  float V,Vo;
12  float Sum=0;
13  for(i=0;i<10;i++)
14  {
15    value=analogRead(4);
16    V=value*5.00/1023;
17    Sum+=V;
18    delay(10);
19  }
20  Vo=Sum/10;
21  Serial.print("Output score:");
22  Serial.println(Vo);
23  delay(1000);
24 }
```

You can view the amplified signals via serial monitor. For the value of the input signal, you need to use the multimeter to measure the voltage difference between VIN+ and VIN-.

## Resources

- [v1.2 Eagle File](#)
- [v1.2 Schematic](#)
- [INA132 Datasheet](#)

## Tech Support

Please submit any technical issue into our [forum](#) or drop mail to [techsupport@seeed.cc](mailto:techsupport@seeed.cc).