

AC Filter 3-Stage, Very High Broad Band Attenuation



The same image is used for FMW-200

See below:
[Approvals and Compliances](#)

Description

- Line-filter in standard version
- 3 stages
- very high attenuation, broadband

Characteristics

- Designed for highest demands
- High attenuation at maximum resp. asymmetric load independent from the line impedance
- For standard and industrial applications
- Suitable for use in equipment according to IEC/UL 62368-1

References

Alternative: Standard version

Weblinks

[pdf data sheet](#), [html datasheet](#), [General Product Information](#), [Approvals](#), [Distributor-Stock-Check](#), [Detailed request for product](#), [Microsite](#)

Technical Data

Ratings IEC	4 - 30A @ Ta 40 °C / 250VAC; 50Hz
Ratings UL/CSA	4 - 30A @ Ta 40 °C / 125VAC; 60Hz
Leakage Current	industrial < 1.5mA (250V / 60Hz)
Dielectric Strength	> 1.7kVDC between L-N > 2.7kVDC between L/N-PE Test voltage (2 sec)
Allowable Operation Temperature	-25 °C to 100 °C
Climatic Category	25/100/21 acc. to IEC 60068-1
Protection Class	Suitable for appliances with protection class I acc. to IEC 61140
Terminal	Screw
Material: Housing	Metal

Line Filter	Industrial version, IEC 60939, UL 1283, CSA C22.2 no. 8 Technical Details
MTBF	> 200'000h acc. to MIL-HB-217 F

Approvals and Compliances

Detailed information on product approvals, code requirements, usage instructions and detailed test conditions can be looked up in [Details about Approvals](#)

SCHURTER products are designed for use in industrial environments. They have approvals from independent testing bodies according to national and international standards. Products with specific characteristics and requirements such as required in the automotive sector according to IATF 16949, medical technology according to ISO 13485 or in the aerospace industry can be offered exclusively with customer-specific, individual agreements by SCHURTER.

Approvals







The approval mark is used by the testing authorities to certify compliance with the safety requirements placed on electronic products.

Approval Reference Type: FMW-150 (200)

Approval Logo	Certificates	Certification Body	Description
	VDE Approvals	VDE	Certificate Number: 40004673
	UL Approvals	UL	UL File Number: E72928

Product standards

Product standards that are referenced

Organization	Design	Standard	Description
	Designed according to	IEC 60320-1	Appliance couplers for household and similar general purposes
	Designed according to	IEC 60939	Passive filters for suppressing electromagnetic interference
	Designed according to	UL 498	Standard for Attachment Plugs and Receptacles
	Designed according to	UL 1283	Electromagnetic interference filters
	Designed according to	CSA C22.2 no. 42	General Use Receptacles, Attachment Plugs, and Similar Wiring Devices
	Designed according to	CSA C22.2 no. 8	Electromagnetic interference (EMI) filters





Application standards

Application standards where the product can be used

Organization	Design	Standard	Description
	Designed for applications acc.	IEC/UL 62368-1	IEC 62368-1 includes the basic requirements for safety of audio, video, information technology and office equipment.

Compliances

The product complies with following Guide Lines

Identification	Details	Initiator	Description
	CE declaration of conformity	SCHURTER AG	The CE marking declares that the product complies with the applicable requirements laid down in the harmonisation of Community legislation on its affixing in accordance with EU Regulation 765/2008.
	RoHS	SCHURTER AG	Directive RoHS 2011/65/EU, Amendment (EU) 2015/863
	China RoHS	SCHURTER AG	The law SJ / T 11363-2006 (China RoHS) has been in force since 1 March 2007. It is similar to the EU directive RoHS.
	REACH	SCHURTER AG	On 1 June 2007, Regulation (EC) No 1907/2006 on the Registration, Evaluation, Authorization and Restriction of Chemicals 1 (abbreviated as "REACH") entered into force.

Dimension [mm]

Case 43

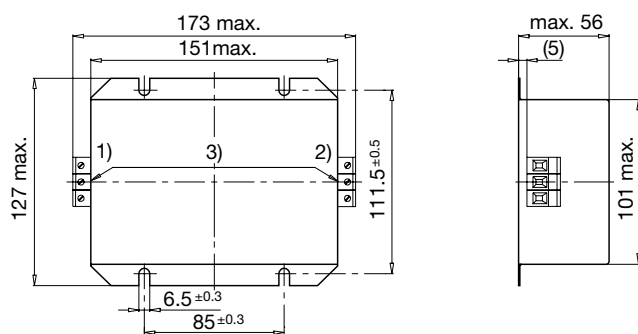

- 1) Line
- 2) Load
- 3) I/O connections torque 0.6...0.8 Nm

Case 22

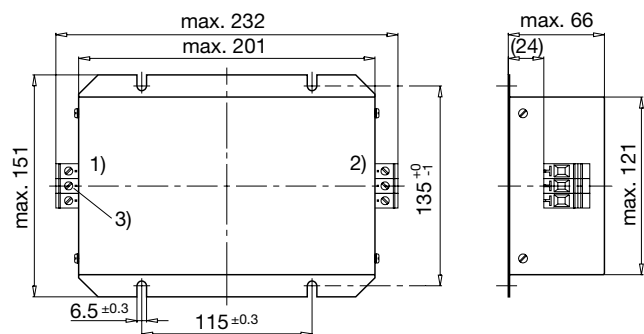

- 1) Line
- 2) Load
- 3) I/O connections torque 1.5...1.8 Nm

Diagrams

Standard version

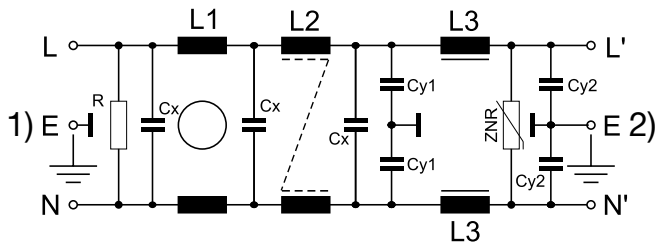

- 1) Line
- 2) Load

Attenuation Loss

- - - 50Ω differential mode _____ 50Ω common mode

Industrial version

4 A

10 A

30 A

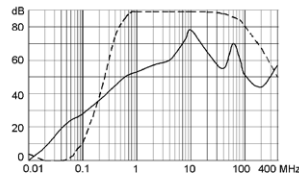
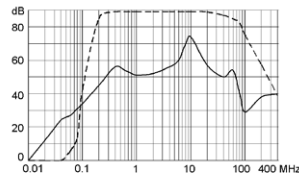
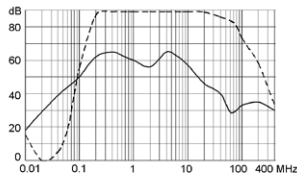

All Variants

Rated Current [A]	Filter-Type	Leakage Current [mA]	L1 [mH]	L2 [μH]	L3 [μH]	Cx [nF]	Cy1 [nF]	Cy2 [nF]	R [MΩ]	Clamps [mm ²]	Weight [kg]	Housings	Order Number
4	Industrial version	3.5	2 x 20	2 x 30	3	220	33	2.2	0.5	4	1600 g	43	5500.2048
10	Industrial version	1.5	2 x 5	2 x 30	3	220	15	-	0.5	4	-	43	5500.2049
30	Industrial version	1.5	2 x 4	2 x 17	3	220	15	-	0.5	6	3220 g	22	5500.2050

Availability for all products can be searched real-time: <https://www.schurter.com/en/Stock-Check/Stock-Check-SCHURTER>

Packaging unit

1 Pcs