

AC Filter for PCB Mounting Cost Optimized



See below:  
[Approvals and Compliances](#)

**Description**

- Line filter in standard and medical version
- 1-stage
- standard attenuation

**Characteristics**

- Cost-saving plastic housing
- Designed for standard applications
- Protection against interference voltage from the mains
- Possible interferences generated in the equipment are strongly attenuated
- For standard applications
- Suitable for use in equipment according to IEC/UL 62368-1

**Other versions on request**

- Version with wire connection
- Medical Version (M80)

**References**

Alternative: Standard version

**Weblinks**

[pdf data sheet](#), [html datasheet](#), [General Product Information](#), [Approvals](#), [Distributor-Stock-Check](#), [Detailed request for product](#), [Microsite](#)

**Technical Data**

|                                 |   |
|---------------------------------|---|
| Ratings IEC                     | 0.6 - 6 A @ Ta 40 °C / 250 VAC; 50 Hz                                       |
| Ratings UL/CSA                  | 0.6 - 6 A @ Ta 40 °C / 125 VAC; 60 Hz                                       |
| Leakage Current                 | standard < 0.25 mA (250 V / 60 Hz)<br>medical < 5 µA (250 V / 60 Hz)        |
| Dielectric Strength             | > 1.7 kVDC between L-N<br>> 2.7 kVDC between L/N-PE<br>Test voltage (2 sec) |
| Allowable Operation Temperature | -25 °C to 85 °C   |
| Climatic Category               | 25/085/21 acc. to IEC 60068-1   |
| Protection Class                | Suitable for appliances with protection class I acc. to IEC 61140           |
| Terminal                        | For PCB mounting, tin-plated  |
| Material: Housing               | Thermoplastic, black, UL 94V-0  |

|             |  |
|-------------|--|
| Line Filter | Standard and Medical Version, IEC 60939, UL 1283, CSA C22.2 no. 8<br><a href="#">Technical Details</a> |
| MTBF        | > 200'000h acc. to MIL-HB-217 F  |

**Approvals and Compliances**



Detailed information on product approvals, code requirements, usage instructions and detailed test conditions can be looked up in [Details about Approvals](#)

SCHURTER products are designed for use in industrial environments. They have approvals from independent testing bodies according to national and international standards. Products with specific characteristics and requirements such as required in the automotive sector according to IATF 16949, medical technology according to ISO 13485 or in the aerospace industry can be offered exclusively with customer-specific, individual agreements by SCHURTER.

**Approvals**







The approval mark is used by the testing authorities to certify compliance with the safety requirements placed on electronic products.

Approval Reference Type: FPP2

| Approval Logo  | Certificates  | Certification Body | Description                  |
|--|---------------|--------------------|------------------------------|
|  | VDE Approvals | VDE                | Certificate Number: 40004673 |
|  | UL Approvals  | UL                 | UL File Number: E72928       |



**Product standards**

Product standards that are referenced

| Organization   | Design                | Standard         | Description   |
|--|-----------------------|------------------|---|
|  | Designed according to | IEC 60320-1      | Appliance couplers for household and similar general purposes         |
|  | Designed according to | IEC 60939        | Passive filters for suppressing electromagnetic interference          |
|  | Designed according to | UL 498           | Standard for Attachment Plugs and Receptacles                         |
|  | Designed according to | UL 1283          | Electromagnetic interference filters                                  |
|  | Designed according to | CSA C22.2 no. 42 | General Use Receptacles, Attachment Plugs, and Similar Wiring Devices |
|  | Designed according to | CSA C22.2 no. 8  | Electromagnetic interference (EMI) filters                            |





**Application standards**

Application standards where the product can be used

| Organization   | Design                         | Standard       | Description  |
|--|--------------------------------|----------------|--|
|  | Designed for applications acc. | IEC/UL 62368-1 | IEC 62368-1 includes the basic requirements for safety of audio, video, information technology and office equipment. |
|  | Designed for applications acc. | IEC 60601-1    | Medical electrical equipment - Part 1: General requirements for basic safety and essential performance               |

**Compliances**

The product complies with following Guide Lines

| Identification   | Details                      | Initiator   | Description   |
|--|------------------------------|-------------|---|
|  | CE declaration of conformity | SCHURTER AG | The CE marking declares that the product complies with the applicable requirements laid down in the harmonisation of Community legislation on its affixing in accordance with EU Regulation 765/2008. |
|  | RoHS                         | SCHURTER AG | Directive RoHS 2011/65/EU, Amendment (EU) 2015/863  |
|  | China RoHS                   | SCHURTER AG | The law SJ / T 11363-2006 (China RoHS) has been in force since 1 March 2007. It is similar to the EU directive RoHS.  |
|  | REACH                        | SCHURTER AG | On 1 June 2007, Regulation (EC) No 1907/2006 on the Registration, Evaluation, Authorization and Restriction of Chemicals 1 (abbreviated as "REACH") entered into force.                               |
|  | Medical Technology           | SCHURTER AG | Suitable for use in medical equipment according to IEC/UL 60601-1   |

Dimension [mm]

Case 13P

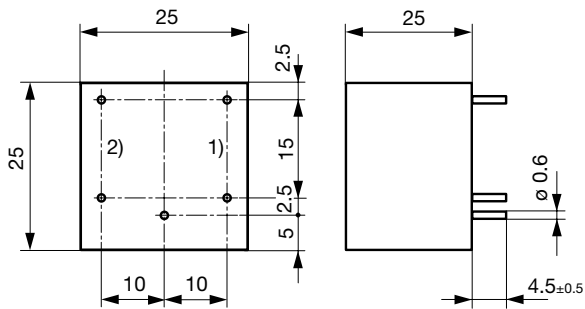

Case 18P

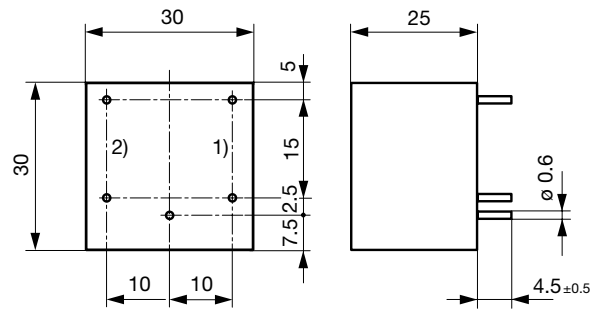

Case 24P

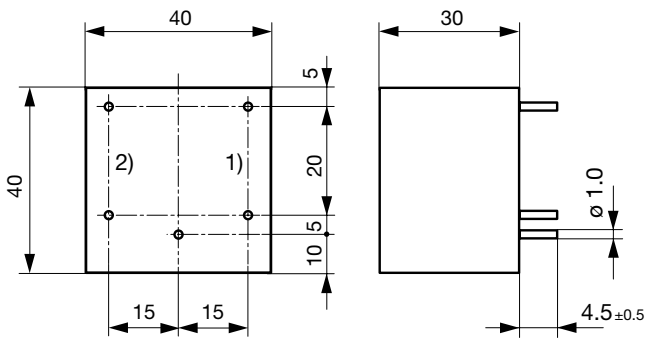

- 1) Line
- 2) Load

Diagrams

S1 standard version

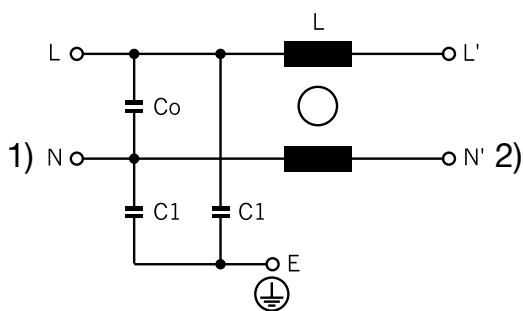

- 1) Line
- 2) Load

S2 medical version

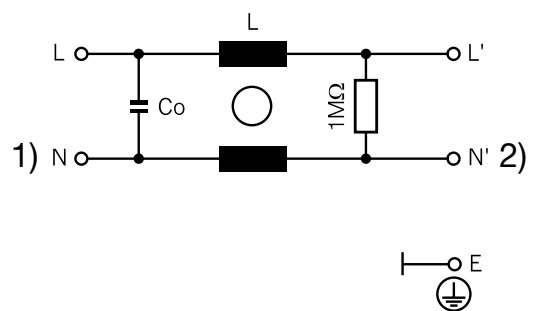

- 1) Line
- 2) Load

**Attenuation Loss**

--- 50Ω differential mode    \_\_\_ 50Ω common mode

Standard version

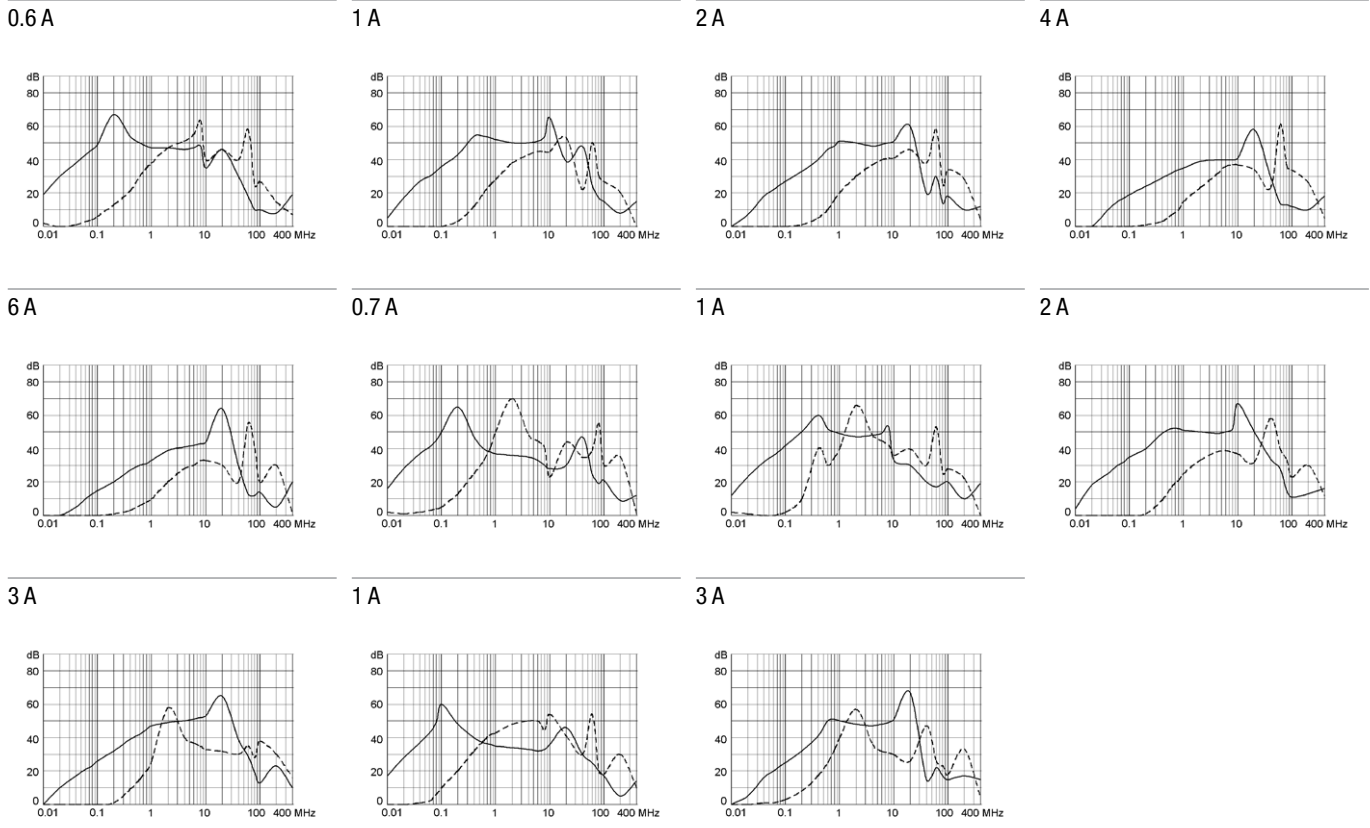

Medical version (M5)

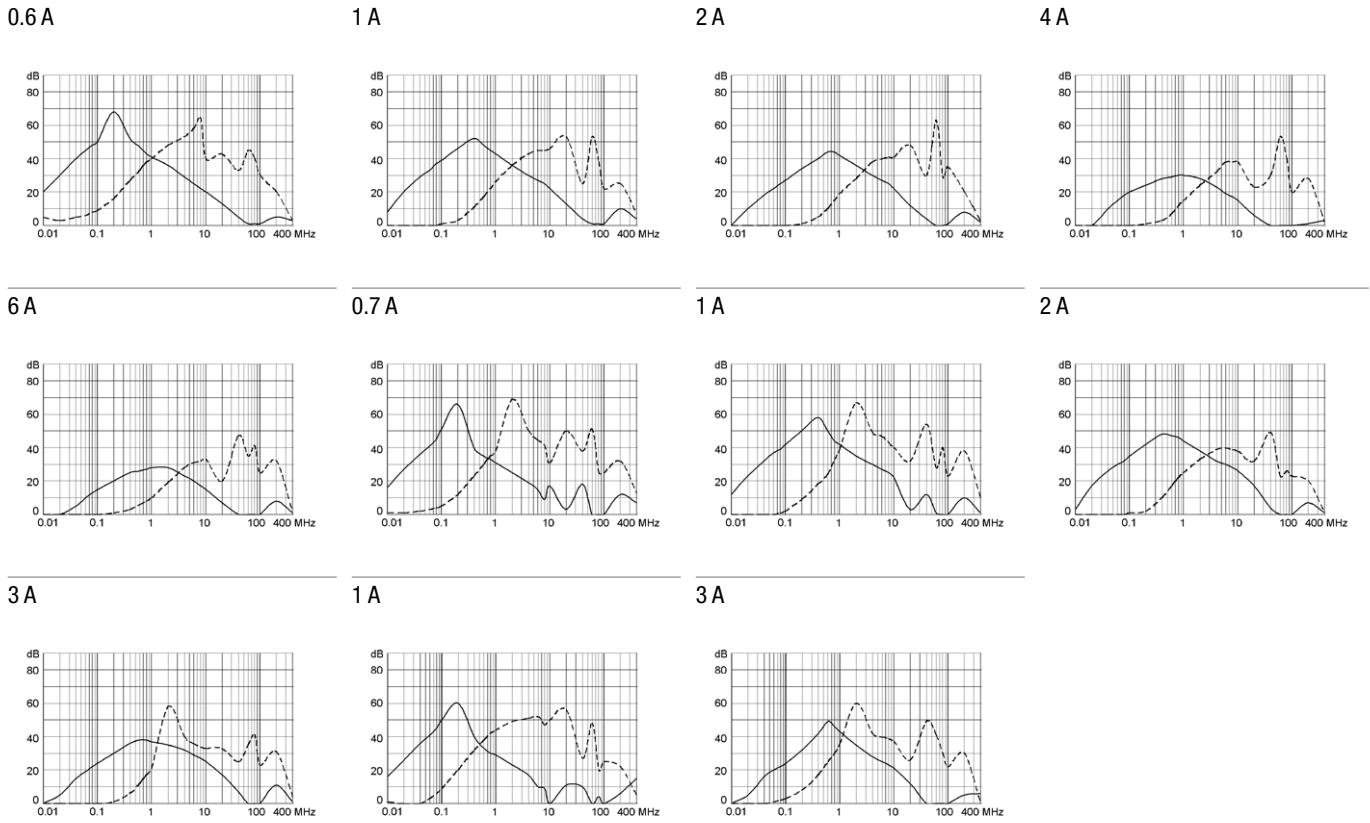

All Variants

| Rated Current [A] | Filter-Type          | L [mH]  | Co / C2 (X2) [µF] | C1 (Y2) [nF] | Diagram | Weight [g] | Housings | Order Number |   |
|-------------------|----------------------|---------|-------------------|--------------|---------|------------|----------|--------------|---|
| 0.6               | Standard version     | 2 x 40  | 0.015             | 2.2          | S1      | 27 g       | 13P      | 5500.2000    | ■ |
| 1                 | Standard version     | 2 x 10  | 0.015             | 2.2          | S1      | 27 g       | 13P      | 5500.2001    | ■ |
| 2                 | Standard version     | 2 x 4   | 0.015             | 2.2          | S1      | 27 g       | 13P      | 5500.2002    | ■ |
| 4                 | Standard version     | 2 x 1.5 | 0.015             | 2.2          | S1      | 27 g       | 13P      | 5500.2003    | ■ |
| 6                 | Standard version     | 2 x 0.8 | 0.015             | 2.2          | S1      | 35 g       | 13P      | 5500.2004    |   |
| 0.7               | Standard version     | 2 x 40  | 0.015             | 2.2          | S1      | 32 g       | 18P      | 5500.2005    |   |
| 1                 | Standard version     | 2 x 20  | 0.022             | 2.2          | S1      | 32 g       | 18P      | 5500.2006    |   |
| 2                 | Standard version     | 2 x 6   | 0.022             | 2.2          | S1      | 32 g       | 18P      | 5500.2007    |   |
| 3                 | Standard version     | 2 x 3   | 0.022             | 2.2          | S1      | 32 g       | 18P      | 5500.2008    | ■ |
| 1                 | Standard version     | 2 x 30  | 0.047             | 2.2          | S1      | 78 g       | 24P      | 5500.2009    |   |
| 3                 | Standard version     | 2 x 4   | 0.047             | 2.2          | S1      | 78 g       | 24P      | 5500.2010    |   |
| 0.6               | Medical Version (M5) | 2 x 40  | 0.015             | -            | S2      | 35 g       | 13P      | 5500.2116    |   |
| 1                 | Medical Version (M5) | 2 x 10  | 0.015             | -            | S2      | 35 g       | 13P      | 5500.2117    |   |
| 2                 | Medical Version (M5) | 2 x 4   | 0.015             | -            | S2      | 25.5 g     | 13P      | 5500.2118    |   |
| 4                 | Medical Version (M5) | 2 x 1.5 | 0.015             | -            | S2      | 35 g       | 13P      | 5500.2119    |   |
| 6                 | Medical Version (M5) | 2 x 0.8 | 0.015             | -            | S2      | 35 g       | 13P      | 5500.2120    |   |
| 0.7               | Medical Version (M5) | 2 x 40  | 0.015             | -            | S2      | 45 g       | 18P      | 5500.2121    |   |
| 1                 | Medical Version (M5) | 2 x 20  | 0.022             | -            | S2      | 45 g       | 18P      | 5500.2122    |   |
| 2                 | Medical Version (M5) | 2 x 6   | 0.022             | -            | S2      | 45 g       | 18P      | 5500.2123    |   |
| 3                 | Medical Version (M5) | 2 x 3   | 0.022             | -            | S2      | 45 g       | 18P      | 5500.2124    |   |
| 1                 | Medical Version (M5) | 2 x 30  | 0.047             | -            | S2      | 78 g       | 24P      | 5500.2125    |   |
| 3                 | Medical Version (M5) | 2 x 4   | 0.047             | -            | S2      | 78 g       | 24P      | 5500.2126    |   |

■ Most Popular.

Availability for all products can be searched real-time: <https://www.schurter.com/en/Stock-Check/Stock-Check-SCHURTER>

**Packaging unit**      50 Pcs