

Shock-Safe Fuseholder, 5 x 20 mm, Slotted Cap/Fingergrip, IP 40 / IP 67, IEC 60335-1



Closed fuseholder 5 x 20 mm  
 slotted  
 black

Screw-on mounting  
 from front side  
 horizontal with finger grip  
 fingergrip

250 VAC · 2.5W/10A (VDE) · 500V · 16A (UL/CSA)

See below:  
[Approvals and Compliances](#)

### Description

- Compact design
- Heading with fingergrip and slotted available
- Degree of protection IP67 available
- White color available on request

### Applications

- Household appliances
- Medical Equipment

### Weblinks

[pdf data sheet](#), [html datasheet](#), [General Product Information](#), [Packaging details](#), [Distributor-Stock-Check](#), [Accessories](#), [Detailed request for product](#), [Microsite](#)

### Technical Data

|                              |                                                                                                                                                           |
|------------------------------|-----------------------------------------------------------------------------------------------------------------------------------------------------------|
| Shock-Safe Category          | PC2                                                                                                                                                       |
| Fuse-Link                    | 5 x 20 mm                                                                                                                                                 |
| Mounting                     | Panel mount, Front Side                                                                                                                                   |
| Attachment                   | Fixing Nut                                                                                                                                                |
| Terminal                     | Solder or Quick-Connect 4.8 x 0.5 mm                                                                                                                      |
| Rated Voltage                | 250VAC (VDE), 500V (UL/CSA)                                                                                                                               |
| Rated current                | 10A (VDE), 16A (UL/CSA)                                                                                                                                   |
| Rated Power Acceptance IEC   | 2.5W / 10A @ Ta 23°C<br>Admissible power acceptance at higher ambient temperature see derating curves                                                     |
| Degree of Protection         | IP 40 / IP 67                                                                                                                                             |
| Protection Class             | Suitable for appliances with protection class I acc. to IEC 61140                                                                                         |
| Admissible Ambient Air Temp. | -40°C to 85°C                                                                                                                                             |
| Climatic Category            | 40/085/21 acc. to IEC 60068-1                                                                                                                             |
| Material: Socket             | Thermoplastic, black, UL 94V-0                                                                                                                            |
| Material: Terminals          | Tin-Plated Copper Alloy                                                                                                                                   |
| Unit Weight                  | 5.7 g                                                                                                                                                     |
| Storage Conditions           | 0°C to 60°C, max. 70% r.h.                                                                                                                                |
| Product Marking              |  Type, Rated Voltage, Rated current, Power Rating, Certification marks |

|                                 |                                                         |
|---------------------------------|---------------------------------------------------------|
| Soldering Methods               | Iron<br><a href="#">Soldering Profile</a>               |
| Solderability                   | 350°C / 3sec acc. to IEC 60068-2-20, Test Ta, method 2  |
| Resistance to Soldering Heat    | 350°C / 10sec acc. to IEC 60068-2-20, Test Tb, method 2 |
| Contact Resistance              | ≤ 10 mΩ at 100 mA acc. to IEC 60127-6                   |
| Dielectric Strength             | > 3kV between life parts<br>(50Hz: 1 min)               |
| Impulse Withstand Voltage       | > 4kV between life parts                                |
| Insulation Resistance           | ≥ 10 MΩ between life parts<br>(500VDC: 1 min)           |
| Overvoltage Category            | III acc. to IEC 60664-1                                 |
| Pollution Degree                | 3 acc. to IEC 60664-1                                   |
| Resistance to Vibration         | acc. to IEC 60068-2-6, test Fc                          |
| Admissible Torque on Fixing Nut | max 1.2 Nm                                              |
| Panel Thickness                 | max 6 mm                                                |

### Approvals and Compliances



Detailed information on product approvals, code requirements, usage instructions and detailed test conditions can be looked up in [Details about Approvals](#)

SCHURTER products are designed for use in industrial environments. They have approvals from independent testing bodies according to national and international standards. Products with specific characteristics and requirements such as required in the automotive sector according to IATF 16949, medical technology according to ISO 13485 or in the aerospace industry can be offered exclusively with customer-specific, individual agreements by SCHURTER.

## Approvals



The approval mark is used by the testing authorities to certify compliance with the safety requirements placed on electronic products.

Approval Reference Type: FPG1

| Approval Logo                                                                    | Certificates  | Certification Body | Description                    |
|----------------------------------------------------------------------------------|---------------|--------------------|--------------------------------|
|  | VDE Approvals | VDE                | VDE Certificate Number: 127216 |
|  | UL Approvals  | UL                 | UL File Number: E39328         |
|  | KTL Approvals | KTL                | Korea Testing Laboratory       |



## Product standards

Product standards that are referenced

| Organization                                                                     | Design                | Standard             | Description                                                    |
|----------------------------------------------------------------------------------|-----------------------|----------------------|----------------------------------------------------------------|
|  | Designed according to | IEC 60127-6          | Miniature fuses. Part 6. Fuse-holders for miniature fuse-links |
|  | Designed according to | UL 4248-1            | Fuseholder general requirements                                |
|  | Designed according to | CSA C22.2 no. 4248.1 | Fuseholder general requirements                                |





## Application standards

Application standards where the product can be used

| Organization                                                                      | Design                         | Standard       | Description                                                                                                                                                                                                                  |
|-----------------------------------------------------------------------------------|--------------------------------|----------------|------------------------------------------------------------------------------------------------------------------------------------------------------------------------------------------------------------------------------|
|   | Designed for applications acc. | IEC/UL 62368-1 | IEC 62368-1 includes the basic requirements for safety of audio, video, information technology and office equipment.                                                                                                         |
|  | Designed for applications acc. | IEC 60335-1    | Safety of electrical appliances for household and similar purposes. Meets the requirements for appliances in unattended use. This includes the enhanced requirements of glow wire tests acc. to IEC 60695-2-11 or -12 & -13. |

## Compliances

The product complies with following Guide Lines

| Identification                                                                     | Details                      | Initiator   | Description                                                                                                                                                                                           |
|------------------------------------------------------------------------------------|------------------------------|-------------|-------------------------------------------------------------------------------------------------------------------------------------------------------------------------------------------------------|
|  | CE declaration of conformity | SCHURTER AG | The CE marking declares that the product complies with the applicable requirements laid down in the harmonisation of Community legislation on its affixing in accordance with EU Regulation 765/2008. |
|  | RoHS                         | SCHURTER AG | Directive RoHS 2011/65/EU, Amendment (EU) 2015/863                                                                                                                                                    |
|  | China RoHS                   | SCHURTER AG | The law SJ / T 11363-2006 (China RoHS) has been in force since 1 March 2007. It is similar to the EU directive RoHS.                                                                                  |
|  | REACH                        | SCHURTER AG | On 1 June 2007, Regulation (EC) No 1907/2006 on the Registration, Evaluation, Authorization and Restriction of Chemicals 1 (abbreviated as "REACH") entered into force.                               |
|  | White Paper Glow wire test   | SCHURTER AG | Meets the requirements of IEC 60335-1 for appliances in unattended use. This includes the enhanced requirements of glow wire tests acc. to IEC 60695-2-11 or -12 & -13.                               |

## Dimension [mm]

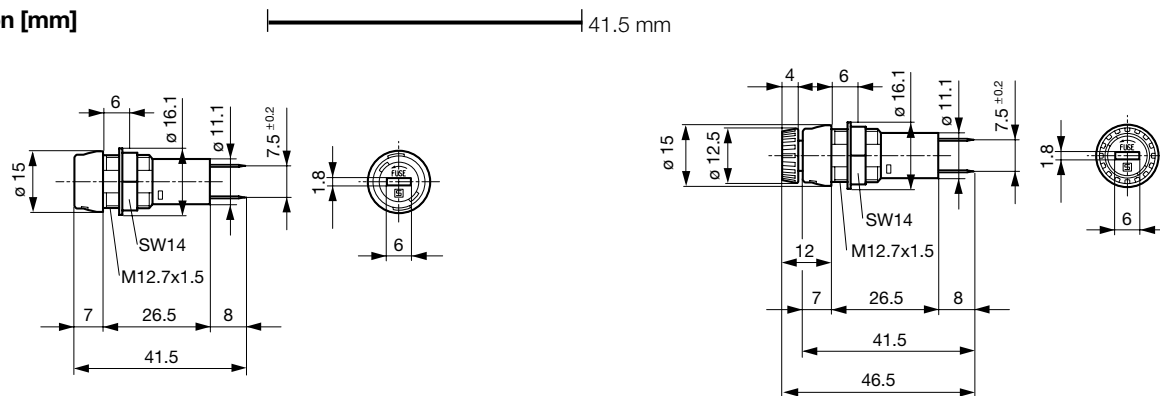

IP40 / Variants 3101.0010 and 3101.0210

IP40 / Variants Fingergrip 3101.0015 and 3101.0215

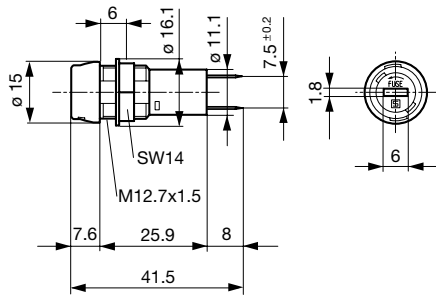

IP67 / Variants 3101.0110 and 3101.0310

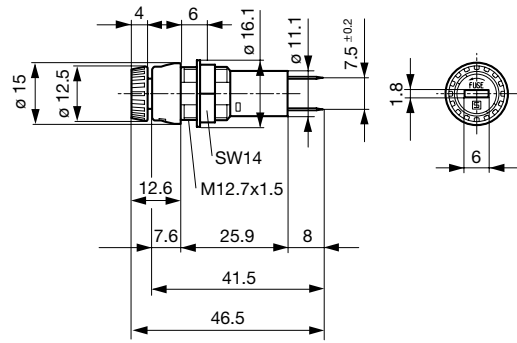

IP67 / Variants Fingerrip 3101.0115 and 3101.0315

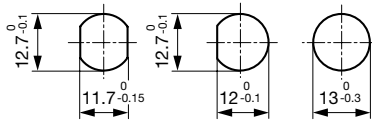

Panel cut-out

### Derating Curves

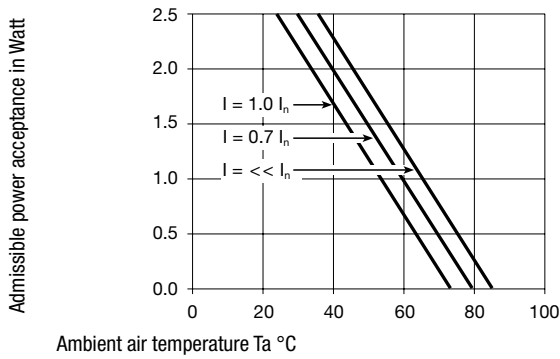

### All Variants

| Holder | Cap       | Terminal                   | Degree of Protection | Material      | Remark | Order Number |
|--------|-----------|----------------------------|----------------------|---------------|--------|--------------|
| ●      | slotted   | Solder                     | IP40                 | Thermoplastic | -      | 3101.0010    |
| ●      | slotted   | Quick-Connect 4.8 x 0.5 mm | IP40                 | Thermoplastic | -      | 3101.0210    |
| ●      | Fingerrip | Solder                     | IP40                 | Thermoplastic | -      | 3101.0015    |
| ●      | Fingerrip | Quick-Connect 4.8 x 0.5 mm | IP40                 | Thermoplastic | -      | 3101.0215    |
| ●      | slotted   | Solder                     | IP67                 | Thermoplastic | -      | 3101.0110    |
| ●      | slotted   | Quick-Connect 4.8 x 0.5 mm | IP67                 | Thermoplastic | -      | 3101.0310    |
| ●      | Fingerrip | Solder                     | IP67                 | Thermoplastic | -      | 3101.0115    |
| ●      | Fingerrip | Quick-Connect 4.8 x 0.5 mm | IP67                 | Thermoplastic | -      | 3101.0315    |

Most Popular.

Availability for all products can be searched real-time: <https://www.schurter.com/en/Stock-Check/Stock-Check-SCHURTER>

**Packaging Unit** Bulk 186 x 91 x 91 mm (100 pcs.)

Accessories

Description



Nut for fuse holder  
Mounting accessories for fuse holder

---