

Line switch with/without bowden cable, fuseh. 5x20/6.3x32 mm, voltage selector

Standard- or Medical-Filter



C14



70° C



### Description

- Panel Mount:  
Screw-on from front side
- 5 Functions:  
Inlet, Line switch for bowdencable actuation, Fuseholder with interchangeable fuse drawer for Fuse-links 5 x 20 mm or 6.3 x 32 mm, with or without voltage selector (step switch), Line filter in standard and medical version
- Quick connect terminals 4.8 x 0.8 mm
- Alternative: version without line filter [KD-Bowdencable](#)

### Approvals

- VDE License Number: 40004665
- UL License Number: E76360

### Characteristics

- All single elements are already wired
- The fuse drawer "Fingergrip" can be removed by hand  
For added safety "Extra-Safe" fuse drawers are available  
Fuse drawer meets requirements of medical standard IEC/EN 60601-1  
The fuse drawer can only be opened with the aid of a tool  
The fuseholder is accessible from the equipment front
- Qualified for use in equipment according IEC/EN 60950

### References

[General Product Information](#)

### Weblinks

[Approvals](#), [RoHS](#), [CHINA-RoHS](#), [e-Store](#), [SCHURTER-Stock-Check](#), [Distributor-Stock-Check](#)

### Technical Data

Ratings IEC	1 - 6A @ Ta 40 °C / 250VAC; Hz 50
Ratings UL/CSA	1 - 8A @ Ta 40 °C / 125VAC; 60Hz
Leakage Current	standard < 0.5 mA (250 V / 60Hz) medical < 5 µA (250 V / 60 Hz)
Dielectric Strength	> 1.7 kVDC between L-N > 2.7 kVDC between L/N-PE Test voltage (2 sec)
Allowable Operation Temp.	-25 °C to 85 °C
Climatic Category	25/085/21 acc. to IEC 60068-1
Degree of Protection	from front side IP 40 acc. to IEC 60529
Protection Class	Suitable for appliances with protection class I acc. to IEC 61140
Terminal	Quick connect terminals 4.8 x 0.8 mm
Panel Thickness s	Screw-on: max 8mm Mounting screw torque max 0.5Nm
Material: Housing	Thermoplastic, black, UL 94V-0

Appliance-Inlet /-Outlet	C14 acc. to IEC/EN 60320-1, UL 498, CSA C22.2 no. 42 (for cold condition) pin-temperature 70 °C, 10A, Protection class I
Fuseholder	1 or 2 pole, Shocksafe category PC2 acc. to IEC 60127-6, for fuse-links 5 x 20 or 6.3 x 32 mm
Rated Power Acceptance @ Ta 23 °C	5 x 20: 2.5W (1 pole)/ 2W (2-pole) per pole 6.3 x 32: 3.15W (1 pole)/ 2.5W (2-pole) per pole
Power Acceptance @ Ta > 23°C	Admissible power acceptance at higher ambient temperature see derating curves
Line Switch	Switch for bowdencable 2-pole, non-illuminated, acc. to IEC 61058-1 <a href="#">Technical details</a>
Voltage selector	optional step, 2-4 digits
Line Filter	Standard and Medical Version, IEC 60939, IEC 60601-1, UL 1283, UL 544, EN 133 200, CSA C22.2 no. 8 <a href="#">Technical details</a>
MTBF	> 1'200'000h acc. to MIL-HB-217 F

## Dimensions

CD bowden cable

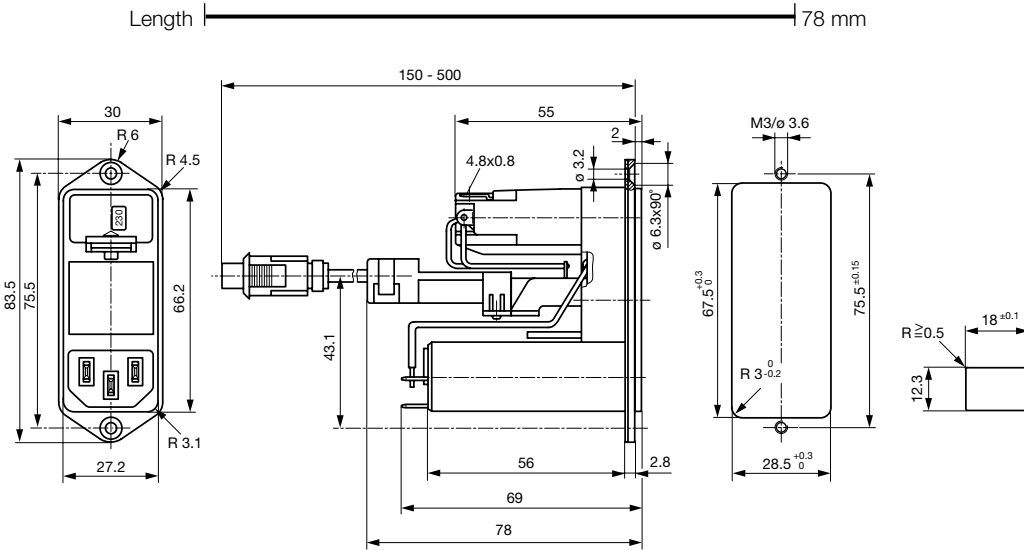

## Technical Data of Filter-Components

Rated Current [A]	Filter-Type	Inductances L [mH]	Capacitance CX [nF]	Capacitance CY [nF]	R [MΩ]
1	Standard Version	2 x 10	68	2.2	-
2	Standard Version	2 x 4	68	2.2	-
4	Standard Version	2 x 1.5	68	2.2	-
6	Standard Version	2 x 0.8	68	2.2	-
1	Medical Version (M5)	2 x 10	68	-	1
2	Medical Version (M5)	2 x 4	68	-	1
4	Medical Version (M5)	2 x 1.5	68	-	1
6	Medical Version (M5)	2 x 0.8	68	-	1

## Diagrams

Standard version with voltage selector

Medical version with voltage selector

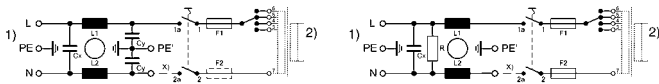

- 1) Line
- 2) Load
- x) External connection to be made by the customer

## Derating Curves

Fuses 5 x 20 mm (1-pole)

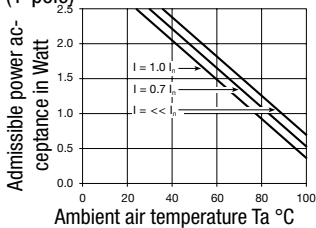

Fuses 5 x 20 mm (2-pole, per pole)

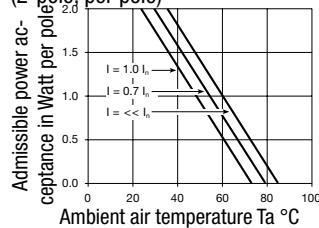

Fuses 6,3 x 32 mm (1-pole)

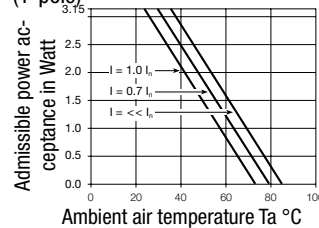

Fuses 6,3 x 32 mm (2-pole, per pole)

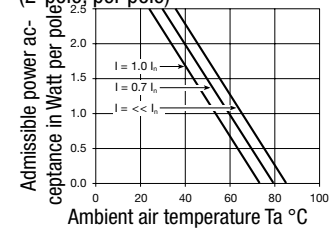

## Attenuation Loss

--- differential mode \_\_\_\_ common mode

Standard version

1 A

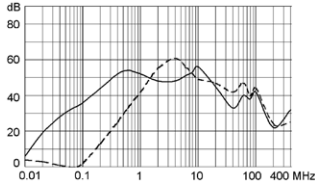

2 A

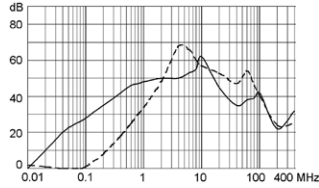

4 A

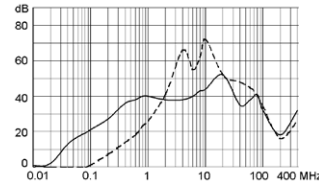

6 A

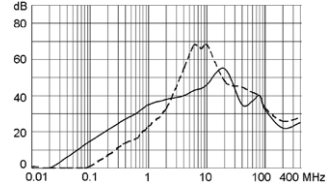

10 A

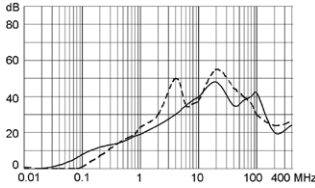

Medical version (M5)

1 A

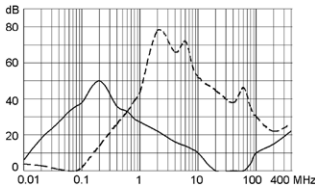

2 A

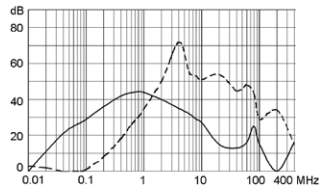

4 A

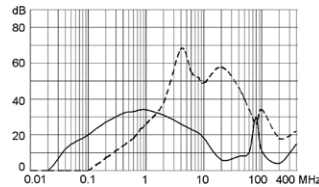

6 A

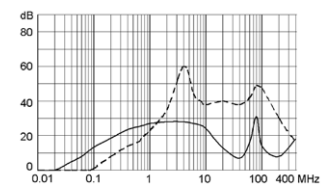

10 A

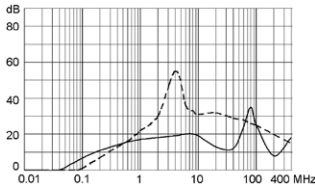

## Variants

[Distributor-Stock-Check](#) | [SCHURTER-Stock-Check](#) | [e-Store](#)

Fuse drawer and bowden cable have to be ordered separately

Type	Rated Current [A]	Filter-Type	Fuseholder	Line Switch	Voltage selector	Order Number
CD-Bowdenzug	1	Standard Version	1 pole	2-pole	2-4 digits	CD11.4599.151
CD-Bowdenzug	2	Standard Version	1 pole	2-pole	2-4 digits	CD21.4599.151
CD-Bowdenzug	4	Standard Version	1 pole	2-pole	2-4 digits	CD31.4599.151
CD-Bowdenzug	6	Standard Version	1 pole	2-pole	2-4 digits	CD41.4599.151
CD-Bowdenzug	1	Standard Version	2-pole	2-pole	2-4 digits	CD14.4199.151
CD-Bowdenzug	2	Standard Version	2-pole	2-pole	2-4 digits	CD24.4199.151
CD-Bowdenzug	4	Standard Version	2-pole	2-pole	2-4 digits	CD34.4199.151
CD-Bowdenzug	6	Standard Version	2-pole	2-pole	2-4 digits	CD44.4199.151
CD-Bowdenzug	1	Medical Version (M5)	2-pole	2-pole	2-4 digits	CDG4.4199.151
CD-Bowdenzug	2	Medical Version (M5)	2-pole	2-pole	2-4 digits	CDA4.4199.151
CD-Bowdenzug	4	Medical Version (M5)	2-pole	2-pole	2-4 digits	CDC4.4199.151
CD-Bowdenzug	6	Medical Version (M5)	2-pole	2-pole	2-4 digits	CDE4.4199.151

Packaging unit

10 Pcs

## Required Accessory

### Description



[Bowdencables incl. accessory](#)  
Bowden Cable for Power Entry Modules



[Fusedrawer 3](#)  
Drawers for fuse links 5x20mm resp. 6.3x32mm

---

## Accessory



[Cord retaining kits](#)  
Cord retaining strain relieve