

# General Purpose AC/DC EMI Filter



- Rated currents from 1 to 60 A
- High differential-mode attenuation
- Optional medical version (B type)
- Optional safety version (A type)



### Performance indicators

Attenuation performance



Rated current [A]



## Technical specifications

<b>Rated voltage*</b>	250 VAC, 50/60 Hz; 250 VDC
<b>Operating frequency</b>	DC to 400 Hz
<b>Rated currents</b>	1 to 60 A @ 40°C max.
<b>High potential test voltage</b>	P → PE 2000 VAC for 2 sec P → PE 2500 VAC for 2 sec (B types) P → N 760 VAC for 2 sec (1 to 20 A types) P → N 1100 VDC for 2 sec (30 and 60 A types)
<b>Temperature range (operation and storage)</b>	-25°C to +100°C (25/100/21)**
<b>Certified to</b>	UL 1283, CSA 22.2 No. 8 1986, IEC/EN 60939 (applies to AC and DC applications)
<b>Flammability corresponding to</b>	Terminal plastic for -06/-08 version: UL 94 V-0 Laces for -07 version: UL 94 VW-1 Grommet for -07 version: UL 94 V-0
<b>Design corresponding to</b>	UL 1283, CSA 22.2 No. 8 1986, IEC/EN 60939
<b>Overvoltage category</b>	II acc. IEC 60664-1
<b>Pollution degree</b>	2 acc. IEC 60664-1
<b>Altitude</b>	2000m (above derating applies)**
<b>MTBF @ 40°C/230 V (Mil-HB-217F)</b>	1,250,000 hours 1,750,000 hours (B types)

\* maximum RMS operating voltage at rated frequency or the maximum DC operating voltage

\*\* for dedicated requests exceeding this specification (e.g. -40 °C or higher altitude) please contact your local Schaffner Sales office

### Approvals



## Features and benefits

- FN 2020 filters are designed for easy and fast chassis mounting
- FN 2020 B versions without capacitors to earth comply to 1MOP for ME (medical equipment) acc. IEC 60601-1
- FN 2020 A versions with low capacitance to earth for safety critical applications with necessity for low leakage currents
- All filters provide a general purpose conducted attenuation performance, based on chokes with high saturation resistance and excellent thermal behavior
- FN 2020 filters can be used to cover a broad range of usage and they offer a good size/ampereage ratio
- FN 2020 filters are also available as two-stage filters (FN 2060, FN 2070 series) for more noisy environment
- Various terminal options allow you to select the desired connection style



## Typical applications

- Electrical and electronic equipment
- Consumer goods
- Household equipment
- Medical equipment
- Office automation equipment
- Datacom equipment

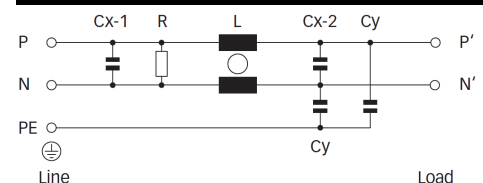
### Typical electrical schematic



## Filter selection table

Filter*	Rated current @ 40°C (25°C)  [A]	Leakage current** @ 250 VAC/50 Hz (@ 120 VAC/60 Hz)  [mA]	Inductance***  L  [mH]	Capacitance***		Resistance***  R  [kΩ]	Input/Output connections			Weight  [g]
				Cx  [μF]	Cy  [nF]					
<b>FN 2020-1-..</b>	1 (1.15)	0.66 (0.38)	12	0.15	4.7	1000	-06	-07		80
<b>FN 2020-3-..</b>	3 (3.45)	0.66 (0.38)	2.5	0.15	4.7	1000	-06	-07		80
<b>FN 2020-6-..</b>	6 (6.9)	0.66 (0.38)	1	0.15	4.7	1000	-06	-07		80
<b>FN 2020-10-..</b>	10 (11.5)	0.66 (0.38)	0.8	0.15	4.7	1000	-06	-07		85
<b>FN 2020-12-..</b>	12 (13.8)	0.66 (0.38)	0.7	0.15	4.7	1000	-06	-07		85
<b>FN 2020-16-..</b>	16 (18.4)	0.66 (0.38)	0.65	0.15	4.7	1000	-06	-07	-08	140
<b>FN 2020-20-..</b>	20 (23)	0.66 (0.38)	0.6	0.15	4.7	1000	-06		-08	210
<b>FN 2020-30-08</b>	30 (34.5)	0.79 (0.45)	0.67	0.47	10	470			-08	470
<b>FN 2020-60-24</b>	60 (69)	0.79 (0.45)	1	1.5	10	220			-24	1100
<b>FN 2020A-1-..</b>	1 (1.15)	0.07 (0.04)	12	0.15	0.47	1000	-06	-07		80
<b>FN 2020A-3-..</b>	3 (3.45)	0.07 (0.04)	2.5	0.15	0.47	1000	-06	-07		80
<b>FN 2020A-6-..</b>	6 (6.9)	0.07 (0.04)	1	0.15	0.47	1000	-06	-07		80
<b>FN 2020A-10-..</b>	10 (11.5)	0.07 (0.04)	0.8	0.15	0.47	1000	-06	-07		85
<b>FN 2020A-12-..</b>	12 (13.8)	0.07 (0.04)	0.7	0.15	0.47	1000	-06	-07		85
<b>FN 2020A-16-..</b>	16 (18.4)	0.07 (0.04)	0.65	0.15	0.47	1000	-06	-07	-08	140
<b>FN 2020A-20-..</b>	20 (23)	0.07 (0.04)	0.6	0.15	0.47	1000	-06		-08	210
<b>FN 2020A-30-08</b>	30 (34.5)	0.07 (0.04)	0.67	0.47	0.47	470			-08	470
<b>FN 2020A-60-24</b>	60 (69)	0.07 (0.04)	1	1.5	0.47	220			-24	1100
<b>FN 2020B-1-..</b>	1 (1.15)	0.00	12	0.15		1000	-06	-07		80
<b>FN 2020B-3-..</b>	3 (3.45)	0.00	2.5	0.15		1000	-06	-07		80
<b>FN 2020B-6-..</b>	6 (6.9)	0.00	1	0.15		1000	-06	-07		80
<b>FN 2020B-10-..</b>	10 (11.5)	0.00	0.8	0.15		1000	-06	-07		85
<b>FN 2020B-12-..</b>	12 (13.8)	0.00	0.7	0.15		1000	-06	-07		85
<b>FN 2020B-16-..</b>	16 (18.4)	0.00	0.65	0.15		1000	-06	-07	-08	140
<b>FN 2020B-20-..</b>	20 (23)	0.00	0.6	0.15		1000	-06		-08	210
<b>FN 2020B-30-08</b>	30 (34.5)	0.00	0.67	0.47		470			-08	470
<b>FN 2020B-60-24</b>	60 (69)	0.00	1	1.5		220			-24	1100

\* To compile a complete part number, please replace the -.. with the required I/O connection style (e.g. FN 2020-30-08, FN 2020B-10-06).

\*\* Maximum leakage under usual AC operating conditions (acc. IEC60939-3). Note: if the neutral line is interrupted, worst case leakage could reach twice this level.

\*\*\* Tolerances apply: Inductance: -30/+50%, Capacitance: ±20%, Resistance: ±10%

### Typical filter attenuation

Per CISPR 17; A=50 Ω/50 Ω sym; B=50 Ω/50 Ω asym; C=0.1 Ω/100 Ω sym; D=100 Ω/0.1 Ω sym

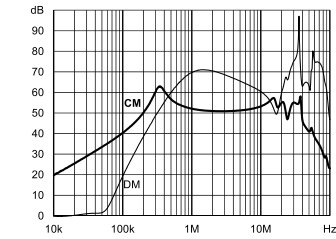

1 A: Standard type

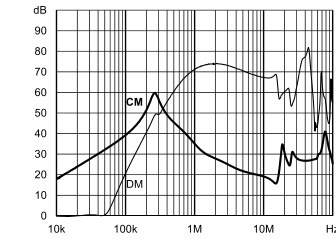

A type

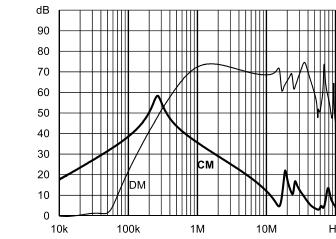

B type

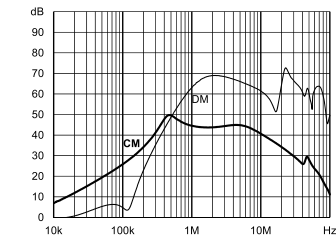

3 A: Standard type

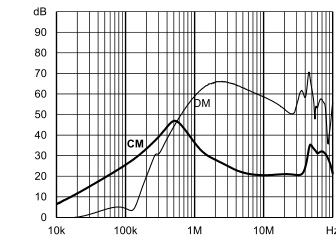

A type

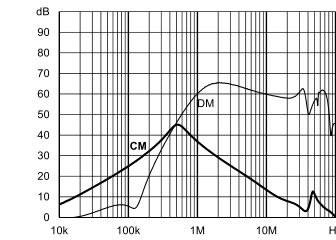

B types

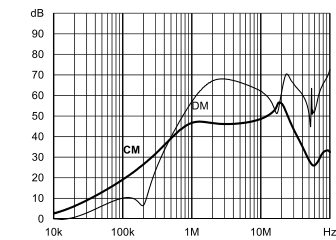

6 A: Standard type

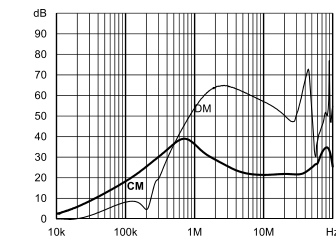

A type

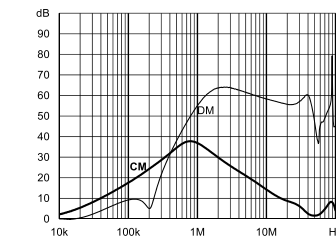

B types

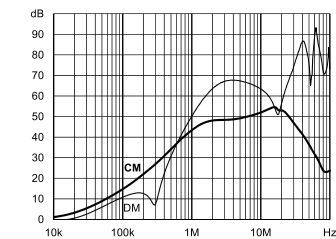

10 A: Standard type

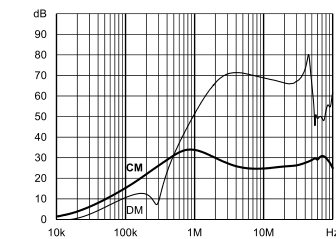

A type

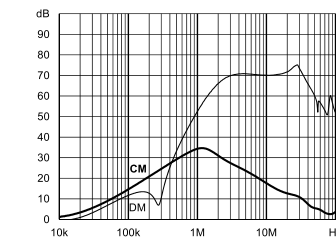

B types

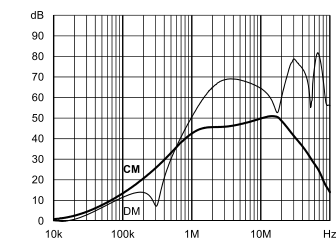

12 A: Standard type

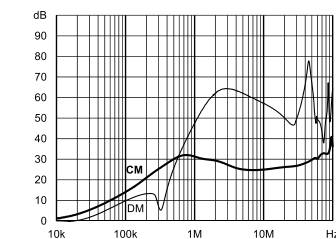

A type

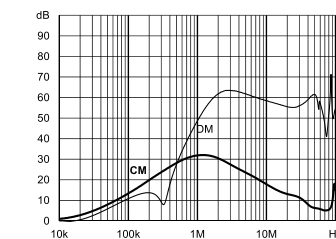

B types

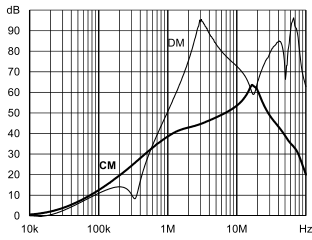

16 A: Standard type

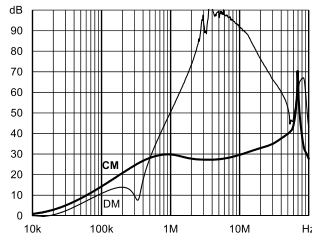

A type

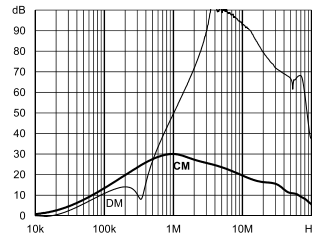

B types

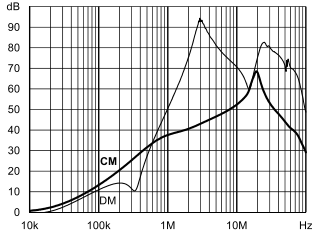

20 A: Standard type

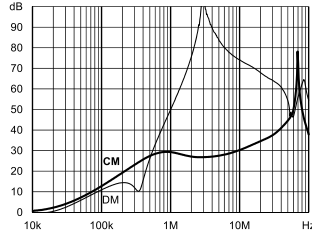

A type

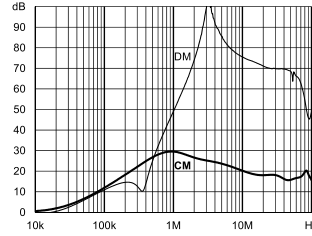

B types

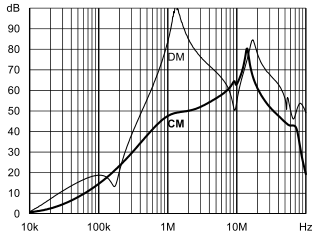

30 A: Standard type

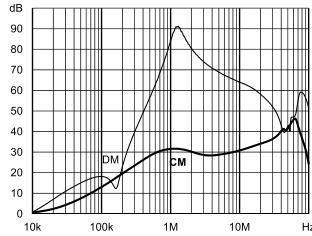

A type

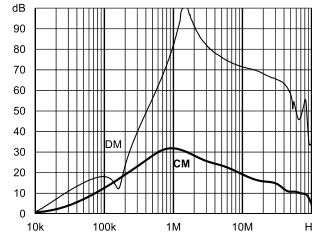

B types

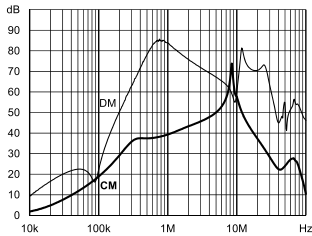

60 A: Standard type

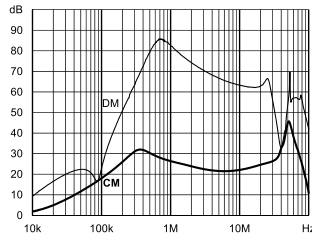

A type

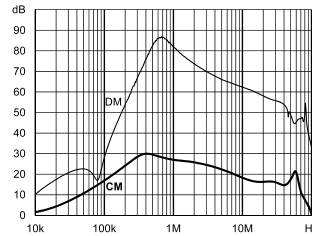

B types

### Product selector

FN 2020 x -xx-yy

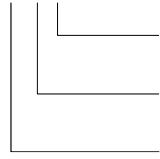

- 06 Faston 6.3 × 0.8 mm (spade/soldering)
- 07 Wire leads
- 08 Studs (M4 screws)
- 24 Studs (M6 screws)
- 1 to 60 Rated current
- Blank Standard version
- A Safety version
- B Medical version

### Mechanical data

#### Connection style -06, 1 to 12 A types

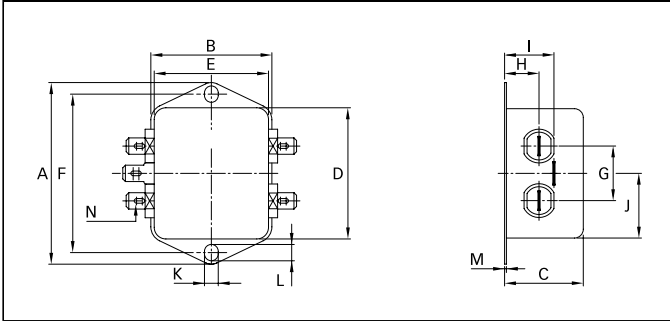

#### Connection style -06, 16 and 20 A types

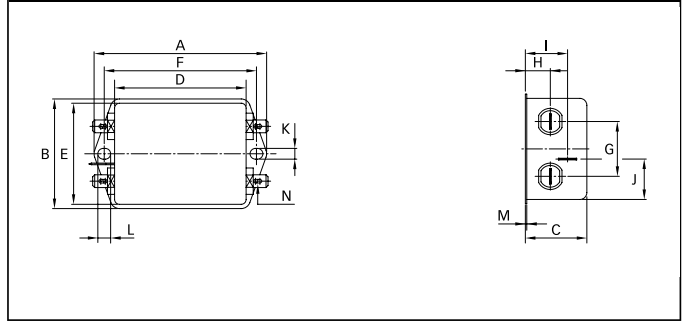

#### Connection style -07, 1 to 12 A types (same dimensions as style -06)

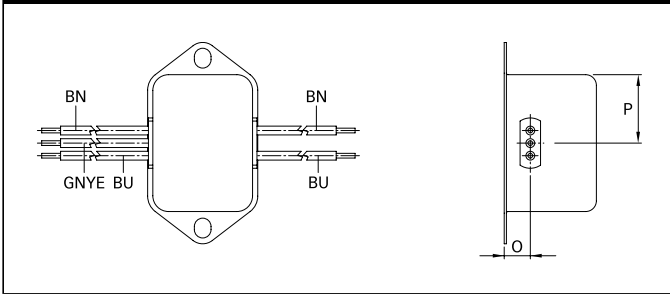

#### Connection style -07, 16 A types (same dimensions as style -06)

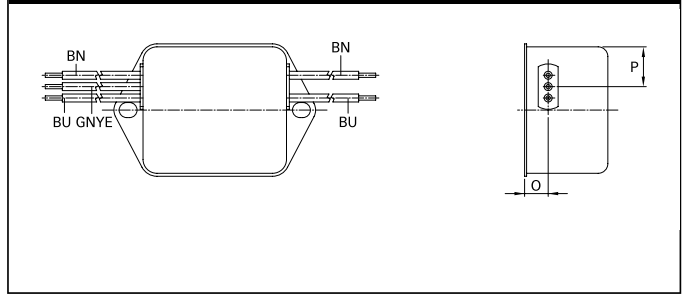

#### Connection style -08, 16 and 20 A types

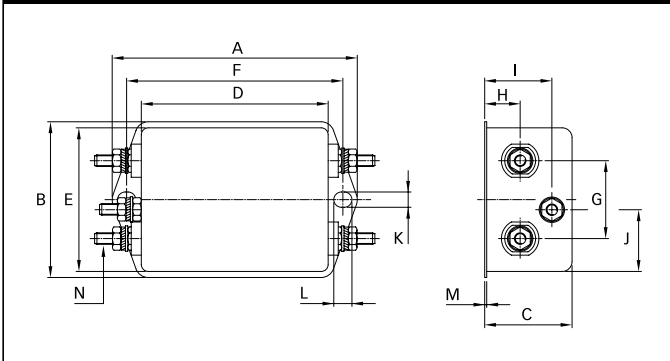

#### Connection style -08, 30 A types

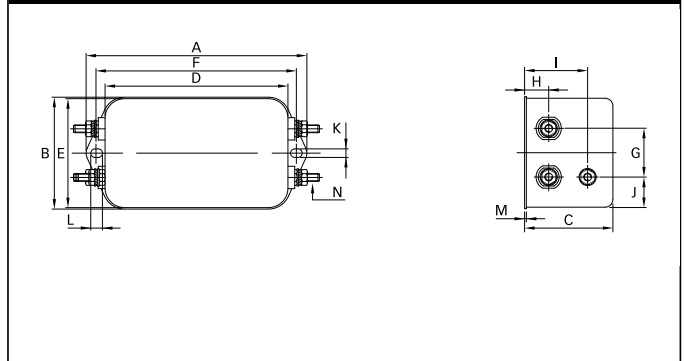

#### Connection style -24

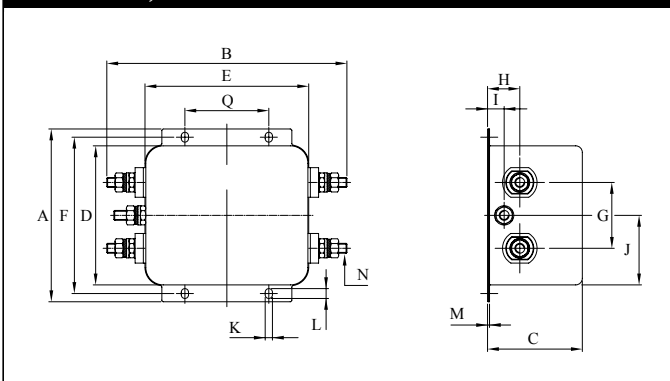

## Dimensions

	1 A	3 A	6 A	10 A	12 A	16 A	20 A	30 A	60 A	Tolerances
<b>A</b>	64	64	64	64	64	71	85	113.5 ±1	105 ±1	±0.5
<b>B</b>	35	35	35	35	35	46.6	54	57.5 ±1	145.9 ±1	±0.5
<b>C</b>	29.3	29.3	29.3	29.3	29.3	29.3	30.3	45.4 ±1	57.6 ±1	±0.5
<b>D</b>	43.5	43.5	43.5	43.5	43.5	50.5	64.8	94 ±1	84.5 ±1	±0.5
<b>E</b>	32.5	32.5	32.5	32.5	32.5	44.5	49.8	56	99.5	±0.5
<b>F</b>	54	54	54	54	54	61	75	103	95	±0.3
<b>G</b>	21	21	21	21	21	21	27	25	40	±0.2
<b>H</b>	9.3	9.3	9.3	9.3	9.3	10.8	12.3	12.4	19.6	±0.5
<b>I</b>	15.3	15.3	15.3	15.3	15.3	19.3	20.8	32.4	10.1	±0.5
<b>J</b>	21.8	21.8	21.8	21.8	21.8	20.1	19.9	15.5	42.25	±0.5
<b>K</b>	5.3	5.3	5.3	5.3	5.3	5.3	5.3	4.4	4.4	
<b>L</b>	6.3	6.3	6.3	6.3	6.3	6.3	6.3	6	6	
<b>M</b>	0.7	0.7	0.7	0.7	0.7	0.7	0.7	1	1.2	±0.3
<b>Connection style -06</b>										
<b>N</b>	6.3 x 0.8	6.3 x 0.8	6.3 x 0.8	6.3 x 0.8	6.3 x 0.8	6.3 x 0.8	6.3 x 0.8			
<b>Connection style -07</b>										
<b>O</b>	8.3	8.3	8.3	8.3	8.3	8.3				±0.5
<b>P</b>	21.8	21.8	21.8	21.8	21.8	14				±0.5
<b>AWG type wire</b>	AWG 20	AWG 20	AWG 18	AWG 18	AWG 16	AWG 16				
<b>Wire length</b>	140	140	140	140	140	140				+5
<b>Connection style -08</b>										
<b>N</b>						M4	M4	M4		
<b>Recommended torque (Nm)</b>						1.2 - 1.3	1.2 - 1.3	1.2 - 1.3		
<b>Earth Terminal</b>						1.5 - 1.7	1.5 - 1.7	1.5 - 1.7		
<b>Connection style -24</b>										
<b>N</b>									M6	
<b>Q</b>									51	±0.2
<b>Recommended torque (Nm)</b>									3.5 - 4	
<b>Earth Terminal</b>									3.5 - 4	

All dimensions in mm; 1 inch = 25.4 mm  
Tolerances according: ISO 2768-m/EN 22768-m

Please visit [www.schaffner.com](http://www.schaffner.com) to find more details on filter connections.



## Headquarters, global innovation and development

### Switzerland

#### Schaffner Group

Industrie Nord  
Nordstrasse 11e  
4542 Luterbach  
T +41 32 681 66 26  
[info@schaffner.com](mailto:info@schaffner.com)



## Sales and application centers

### China

#### Schaffner EMC Ltd. Shanghai

T20-3 C, No 565 Chuangye Road,  
Pudong district  
201201 Shanghai  
T +86 21 3813 9500  
[cschina@schaffner.com](mailto:cschina@schaffner.com)  
[www.schaffner.com.cn](http://www.schaffner.com.cn)

### Finland

#### Schaffner Oy

Sauvonrinne 19 H  
08500 Lohja  
T +358 10 567 2855  
[finlandsales@schaffner.com](mailto:finlandsales@schaffner.com)

### France

#### Schaffner EMC S.A.S.

16-20 Rue Louis Rameau  
95875 Bezons  
T +33 1 34 34 30 60  
F +33 1 39 47 02 28  
[francesales@schaffner.com](mailto:francesales@schaffner.com)

### Germany

#### Schaffner Deutschland GmbH

Schoemperlenstrasse 12B  
76185 Karlsruhe  
T +49 721 56910  
F +49 721 569110  
[germanysales@schaffner.com](mailto:germanysales@schaffner.com)

### India

#### Schaffner India Pvt. Ltd

REGUS WORLD TRADE CENTRE  
WTC, 22nd Floor Unit No 2238, Brigade  
Gateway Campus, 26/1, Dr. Rajkumar Road  
Malleshwaram (W)  
560055 Bangalore  
T +91 80 67935355  
[indiasales@schaffner.com](mailto:indiasales@schaffner.com)

### Italy

#### Schaffner EMC S.r.l.

Via Ticino, 30  
20900 Monza (MB)  
T +39 039 21 41 070  
[italysales@schaffner.com](mailto:italysales@schaffner.com)

### Japan

#### Schaffner EMC K.K.

Taiju-Seimei Sangenjaya Bldg.  
1-32-12, Kamiuma, Setagaya-ku  
154-0011 Tokyo  
T +81 3 5712 3650  
F +81 3 5712 3651  
[japansales@schaffner.com](mailto:japansales@schaffner.com)  
[www.schaffner.jp](http://www.schaffner.jp)

### Singapore

#### Schaffner EMC Pte Ltd.

#05-09, Kg Ubi Ind. Estate  
408705 Singapore  
T +65 6377 3283  
F +65 6377 3281  
[singaporesales@schaffner.com](mailto:singaporesales@schaffner.com)

### Spain

#### Schaffner EMC España

Calle Caléndula 93, Miniparc III, Edificio E  
El Soto de Moraleja, Alcobendas  
28109 Madrid  
T +34 917 912 900  
F +34 917 912 901  
[spainsales@schaffner.com](mailto:spainsales@schaffner.com)

### Sweden

#### Schaffner EMC AB

Östermalmstorg 1  
114 42 Stockholm  
T +46 8 5050 2425  
[swedensales@schaffner.com](mailto:swedensales@schaffner.com)  
[www.schaffner.com](http://www.schaffner.com)

### Switzerland

#### Schaffner EMV AG

Industrie Nord  
Nordstrasse 11e  
4542 Luterbach  
T +41 32 681 66 26  
[switzerlandsales@schaffner.com](mailto:switzerlandsales@schaffner.com)

### Taiwan R.O.C.

#### Schaffner EMV Ltd.

20 Floor-2, No 97, Section 1, XinTai 5th Road  
22175 XiZhi District New Taipei City 22175  
T +886 2 2697 5500  
F +886 2 2697 5533  
[taiwansales@schaffner.com](mailto:taiwansales@schaffner.com)  
[www.schaffner.com.tw](http://www.schaffner.com.tw)

### Thailand

#### Schaffner EMC Co. Ltd.

Northern Region Industrial Estate  
67 Moo 4 Tambon Ban Klang  
Amphur Muangng P.O. Box 14  
51000 Lamphun  
T +66 53 58 11 04  
F +66 53 58 10 19  
[thailandsales@schaffner.com](mailto:thailandsales@schaffner.com)

### United Kingdom

#### Schaffner Ltd.

1, Oakmede Place  
Binfield  
RG42 4JF Berkshire  
T +44 118 9770070  
F +44 118 9792969  
[uksales@schaffner.com](mailto:uksales@schaffner.com)

### USA

#### Schaffner EMC Inc.

52 Mayfield Avenue  
Edison, New Jersey  
T +1 732 225 9533  
F +1 732 225 4789  
[usasales@schaffner.com](mailto:usasales@schaffner.com)  
[www.schaffnerusa.com](http://www.schaffnerusa.com)

#### Schaffner North America

6722 Thirlane Road  
24019 Roanoke, Virginia  
T +1 276 228 7943  
F +1 276 228 7953

#### Schaffner North America

823 Fairview Road  
24382 Wytheville, Virginia  
T +1 276 228 7943  
F +1 276 228 7258

To find your local partner within Schaffner's global network: [www.schaffner.com](http://www.schaffner.com)

© 2018 Schaffner Group

The content of this document has been carefully checked and understood. However, neither Schaffner nor its subsidiaries assume any liability whatsoever for any errors or inaccuracies of this document and the consequences thereof. Published specifications are subject to change without notice. Product suitability for any area of application must ultimately be determined by the customer. In all cases, products must never be operated outside their published specifications. Schaffner does not guarantee the availability of all published products. This disclaimer shall be governed by substantive Swiss law and resulting disputes shall be settled by the courts at the place of business of Schaffner Holding AG. Latest publications and a complete disclaimer can be downloaded from the Schaffner website. All trademarks recognized.