



92x92x25 mm

San Ace 92L 9LG type

General Specifications

- Material Frame: Aluminum, Impeller: Plastic (Flammability: UL 94V-1)
- Expected life See the table below. (L10 life: 90% survival rate for continuous operation in free air at 60°C, rated voltage) Expected life at 40°C is for reference only.
- Motor protection function Locked rotor burnout protection, Reverse polarity protection
For details, please refer to p. 573.
- Dielectric strength 50/60 Hz, 500 VAC, for 1 minute (between lead wire conductors and frame)
- Insulation resistance 10 MΩ or more with a 500 VDC megger (between lead wire conductors and frame)
- Sound pressure level (SPL) At 1 m away from the air inlet
- Storage temperature -30 to +70°C (Non-condensing)
- Lead wire ⊕Red ⊖Black (Sensor) Yellow (Control) Brown
(For models without PWM control function, there is no speed control wiring.)
- Mass 150 g

Specifications

The models listed below **have pulse sensors with PWM control function.**

Model no.	Rated voltage [V]	Operating voltage range [V]	PWM duty cycle [%]	Rated current [A]	Rated input [W]	Rated speed [min ⁻¹]	Max. airflow [m ³ /min] [CFM]	Max. static pressure [Pa] [inchH ₂ O]	SPL [dB (A)]	Operating temperature [°C]	Expected life [h]
9LG0912P4J001	12	10.8 to 13.2	100	0.42	5.04	5000	2.2 77.7	105 0.42	44	-20 to +70	180000/60°C (215000/40°C)
9LG0912P4G001			100	0.3	3.6	4400	1.93 68.2	81 0.33	40		
9LG0912P4S001			100	0.22	2.64	3850	1.69 59.7	62.1 0.25	37		
9LG0912P4H001			100	0.15	1.8	3150	1.38 48.7	41.6 0.17	32		
9LG0924P4J001	24	21.6 to 26.4	100	0.21	5.04	5000	2.2 77.7	105 0.42	44		
9LG0924P4G001			100	0.15	3.6	4400	1.93 68.2	81 0.33	40		
9LG0924P4S001			100	0.11	2.64	3850	1.69 59.7	62.1 0.25	37		
9LG0924P4H001			100	0.07	1.68	3150	1.38 48.7	41.6 0.17	32		

* PWM input frequency is 25 kHz; models without specifications at 0% PWM duty cycle have zero fan speed at 0%.

The following sensor and control options are available for selection.

Differs according to the model. Refer to the table on p. 608. Without sensor Pulse sensor Lock sensor

The models listed below **have pulse sensors.**

Model no.	Rated voltage [V]	Operating voltage range [V]	Rated current [A]	Rated input [W]	Rated speed [min ⁻¹]	Max. airflow [m ³ /min] [CFM]	Max. static pressure [Pa] [inchH ₂ O]	SPL [dB (A)]	Operating temperature [°C]	Expected life [h]
9LG0912F4001	12	10.2 to 13.8	0.1	1.2	2800	1.22 43.1	32.8 0.13	29	-20 to +70	180000/60°C (215000/40°C)
9LG0912M4001			0.08	0.96	2400	1.05 37.1	24.1 0.097	24		
9LG0912L4001			0.07	0.84	2000	0.87 30.7	16.7 0.067	19		
9LG0924F4001	24	20.4 to 27.6	0.05	1.2	2800	1.22 43.1	32.8 0.13	29		
9LG0924M4001			0.04	0.96	2400	1.05 37.1	24.1 0.097	24		
9LG0924L4001			0.03	0.72	2000	0.87 30.7	16.7 0.067	19		

The following sensor and control options are available for selection.

Available for all models. Without sensor Lock sensor

The mark indicates Short LeadTime Service applicable models. See p. 626 for details.

DC Long Life Fan 92 mm sq.

Airflow - Static Pressure Characteristics / PWM Duty - Speed Characteristics Example

9LG0912P4J001 With pulse sensor with PWM control function

PWM duty cycle

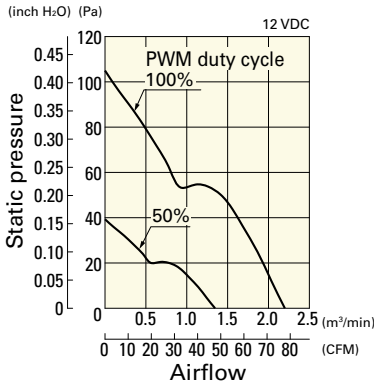

Operating voltage range

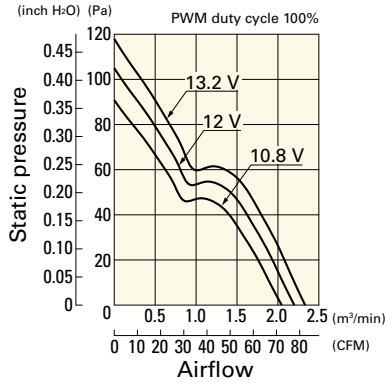

PWM duty - Speed characteristics example

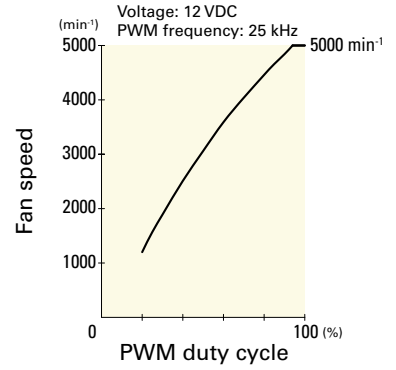

9LG0912P4G001 With pulse sensor with PWM control function

PWM duty cycle

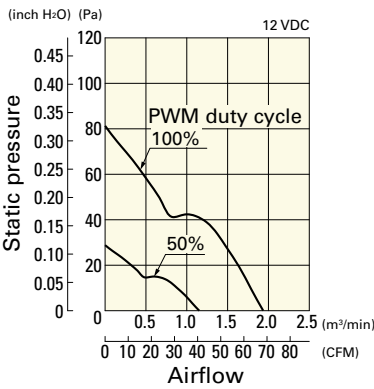

Operating voltage range

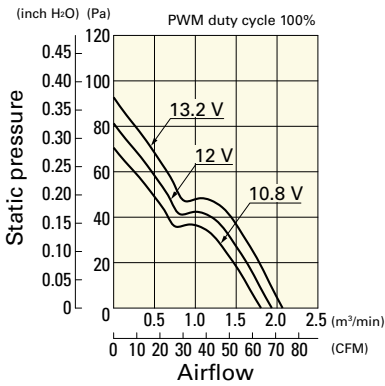

PWM duty - Speed characteristics example

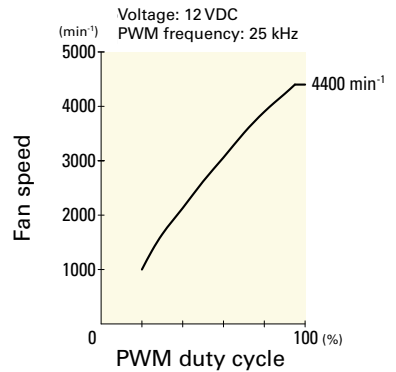

9LG0912P4S001 With pulse sensor with PWM control function

PWM duty cycle

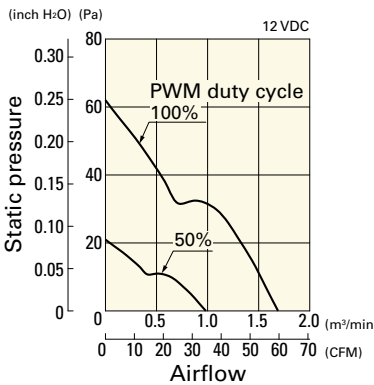

Operating voltage range

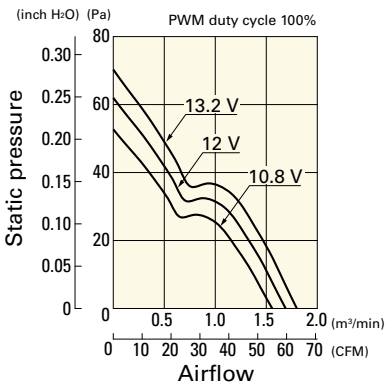

PWM duty - Speed characteristics example

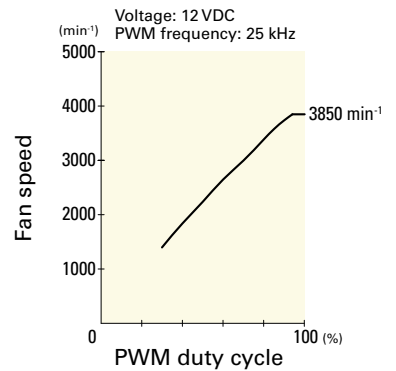

9LG0912P4H001 With pulse sensor with PWM control function

PWM duty cycle

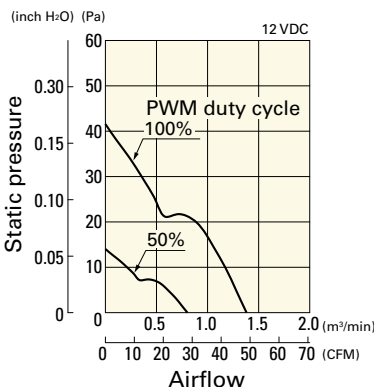

Operating voltage range

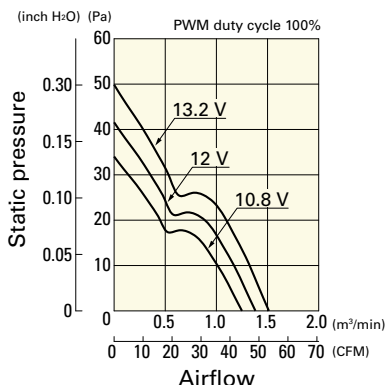

PWM duty - Speed characteristics example

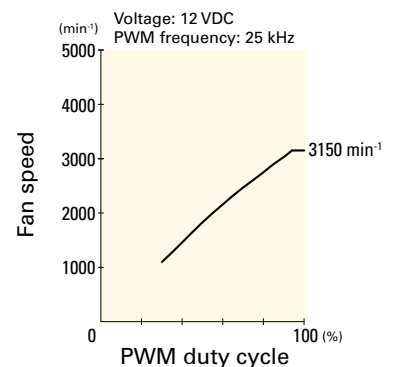

DC
Long Life Fan 92 mm sq.

Airflow - Static Pressure Characteristics / PWM Duty - Speed Characteristics Example

9LG0924P4J001 With pulse sensor with PWM control function

PWM duty cycle

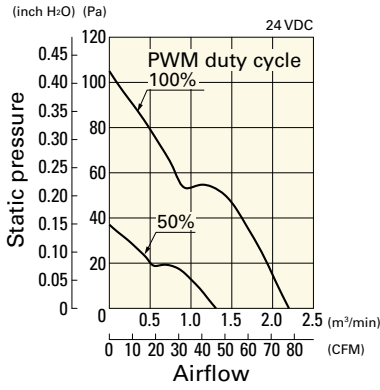

Operating voltage range

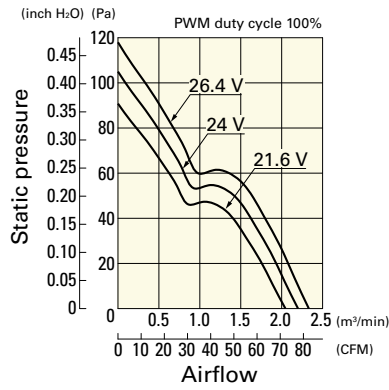

PWM duty - Speed characteristics example

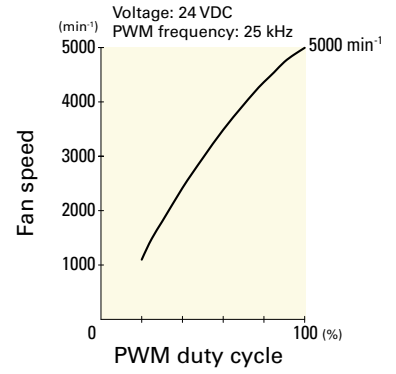

9LG0924P4G001 With pulse sensor with PWM control function

PWM duty cycle

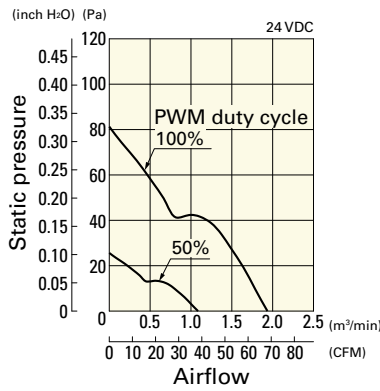

Operating voltage range

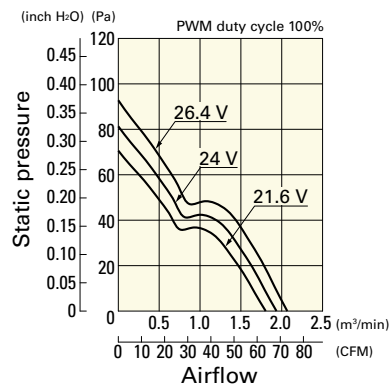

PWM duty - Speed characteristics example

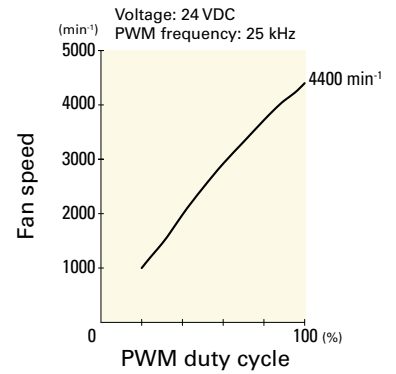

9LG0924P4S001 With pulse sensor with PWM control function

PWM duty cycle

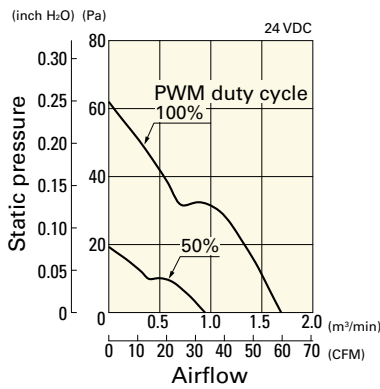

Operating voltage range

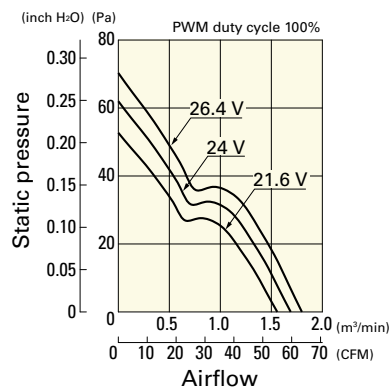

PWM duty - Speed characteristics example

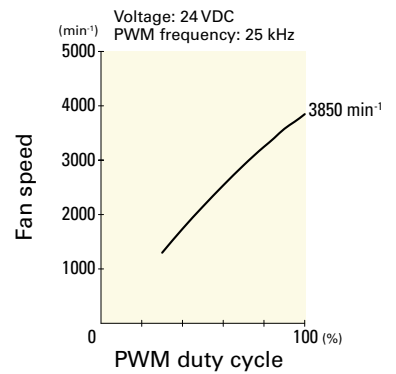

9LG0924P4H001 With pulse sensor with PWM control function

PWM duty cycle

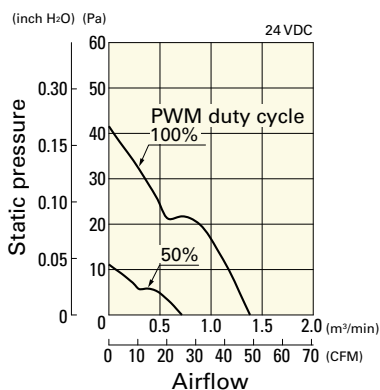

Operating voltage range

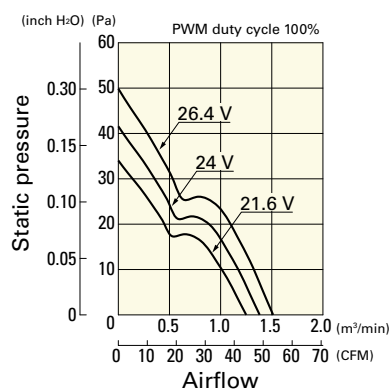

PWM duty - Speed characteristics example

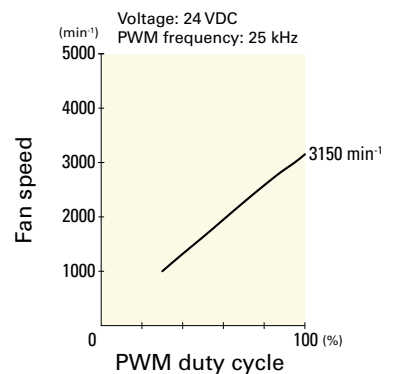

DC Long Life Fan 92 mm sq.

Airflow - Static Pressure Characteristics

9LG0912F4001 With pulse sensor

Operating voltage range

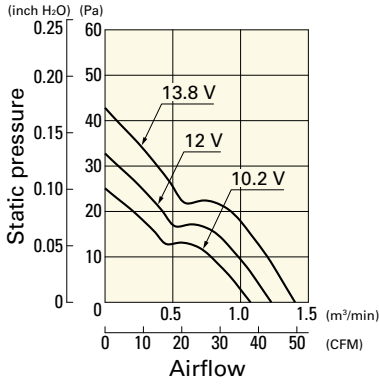

9LG0912M4001 With pulse sensor

Operating voltage range

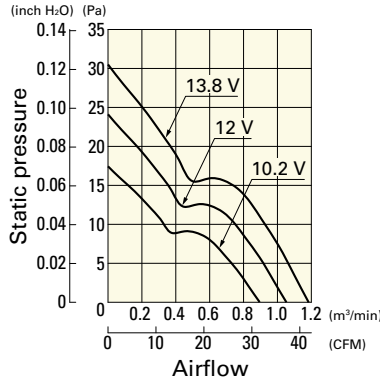

9LG0912L4001 With pulse sensor

Operating voltage range

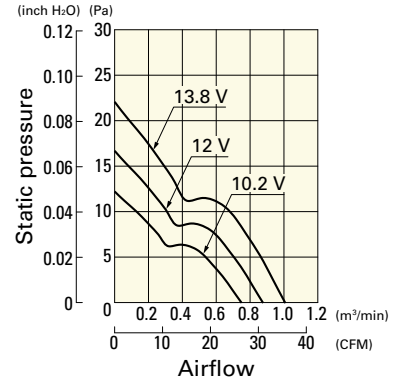

9LG0924F4001 With pulse sensor

Operating voltage range

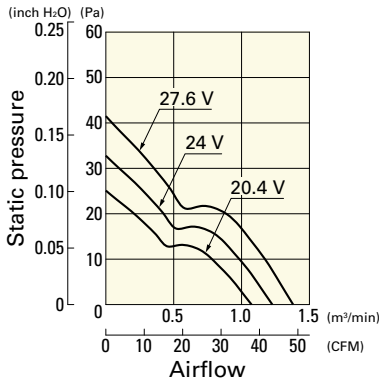

9LG0924M4001 With pulse sensor

Operating voltage range

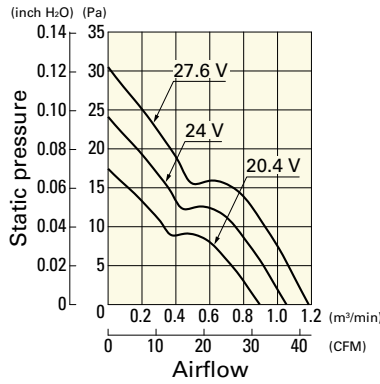

9LG0924L4001 With pulse sensor

Operating voltage range

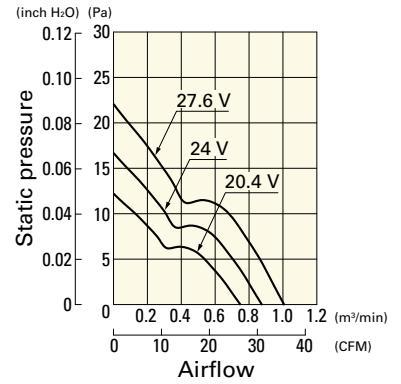

Dimensions (unit: mm)

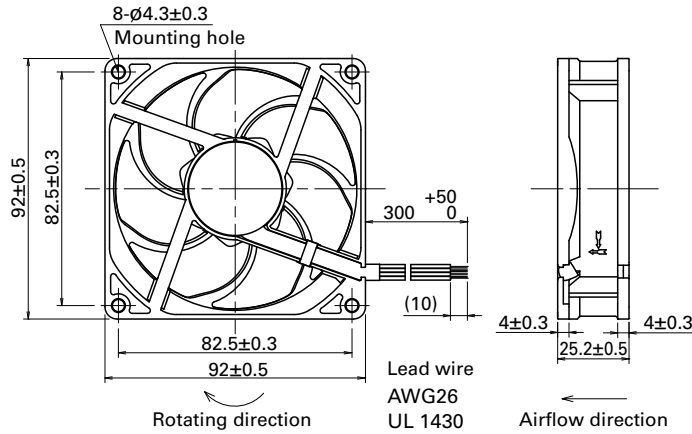

DC
Long Life Fan 92 mm sq.

Reference Dimensions of Mounting Holes and Vent Opening (unit: mm)

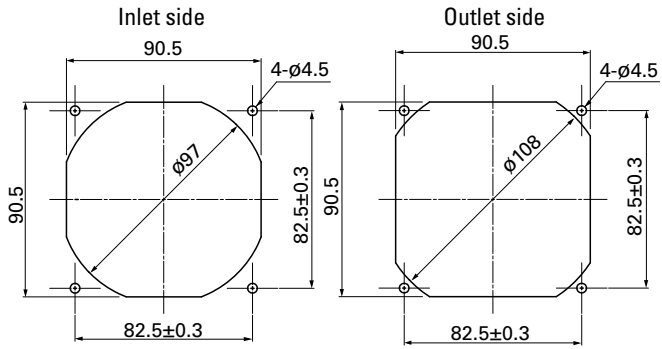

Options

Finger guards

page: p. 558

Model no.: 109-099E, 109-099H, 109-099C

Resin finger guards

page: p. 565

Model no.: 109-1001G

Resin filter kits

page: p. 566

Model no.: 109-1001F13 (13PPI), 109-1001F20 (20PPI),
109-1001F30 (30PPI), 109-1001F40 (40PPI)

DC

Long Life Fan 92 mm sq.