



92x92x25 mm

San Cooler 92 9A type   



General Specifications

- Material Frame: Plastic (Flammability: UL 94V-0), Impeller: Plastic (Flammability: UL 94V-0)
- Expected life See the table below. (L10 life: 90% survival rate for continuous operation in free air at 60°C, rated voltage)
Expected life at 40°C is for reference only.
- Motor protection function Locked rotor burnout protection, Reverse polarity protection
For details, please refer to p. 573.
- Dielectric strength 50/60 Hz, 500 VAC, for 1 minute (between lead wire conductors and frame)
- Insulation resistance 10 MΩ or more with a 500 VDC megger (between lead wire conductors and frame)
- Sound pressure level (SPL) At 1 m away from the air inlet
- Storage temperature -30 to +70°C (Non-condensing)
- Lead wire ⊕Red ⊖Black or Blue Sensor Yellow
- Mass 100 g

Specifications

The models listed below **have ribs and pulse sensors**. For models without ribs, append "1" to the end of model numbers.

Model no.	Rated voltage [V]	Operating voltage range [V]	Rated current [A]	Rated input [W]	Rated speed [min ⁻¹]	Max. airflow [m ³ /min] [CFM]	Max. static pressure [Pa] [inchH ₂ O]	SPL [dB (A)]	Operating temperature [°C]	Expected life [h]
9A0912G401	12	6 to 13.8	0.39	4.68	3900	1.76 62.1	66.5 0.267	43	-20 to +60	30000/60°C (53000/40°C)
9A0912S401			0.27	3.24	3550	1.66 58.6	56.1 0.225	39		
9A0912H401			0.21	2.52	3150	1.45 51.2	44 0.177	33		
9A0912F401			0.14	1.68	2650	1.24 43.8	32.2 0.129	30		
9A0912M401			0.12	1.44	2250	1.04 36.7	22.6 0.091	27		
9A0912L401		7 to 13.8	0.07	0.84	1750	0.8 28.2	13.4 0.054	23		
9A0924G401	24	12 to 27.6	0.19	4.56	3900	1.76 62.1	66.5 0.267	43	-20 to +60	30000/60°C (53000/40°C)
9A0924S401			0.15	3.6	3550	1.66 58.6	56.1 0.225	39		
9A0924H401			0.1	2.4	3150	1.45 51.2	44 0.177	33		
9A0924F401			0.08	1.92	2650	1.24 43.8	32.2 0.129	30		
9A0924M401			0.05	1.2	2250	1.04 36.7	22.6 0.091	27		
9A0924L401		14 to 27.6	0.04	0.96	1750	0.8 28.2	13.4 0.054	23		
9A0948S401	48	40.5 to 53	0.08	3.84	3550	1.66 58.6	56.1 0.225	39	-20 to +60	

The following sensor and control options are available for selection.

Available for all models. **Without sensor**

Differs according to the model. Refer to the table on p. 598. **Lock sensor** **PWM control**

The  mark indicates Short LeadTime Service applicable models. See p. 626 for details.

Airflow - Static Pressure Characteristics

9A0912G401 With pulse sensor

Operating voltage range

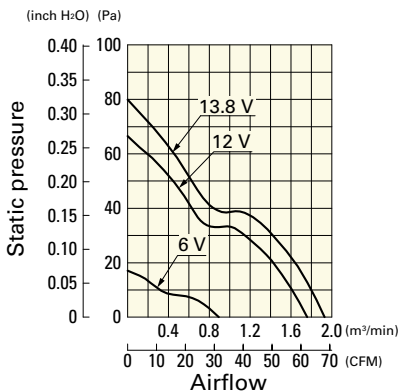

9A0912S401 With pulse sensor

Operating voltage range

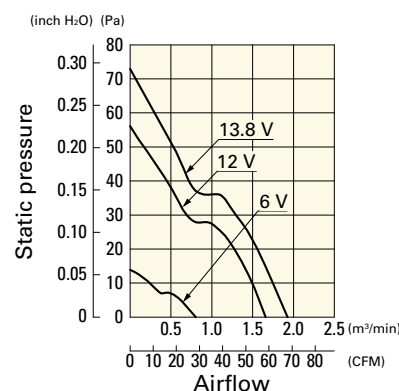

9A0912H401 With pulse sensor

Operating voltage range

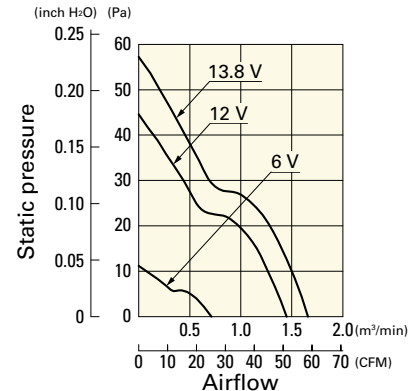

Airflow - Static Pressure Characteristics

9A0912F401 With pulse sensor

Operating voltage range

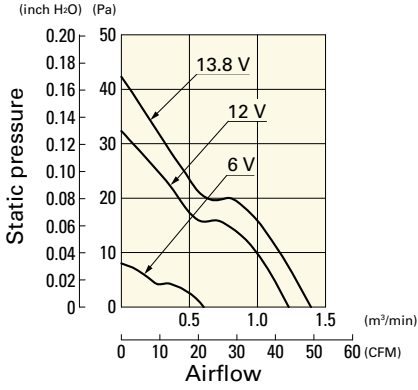

9A0912M401 With pulse sensor

Operating voltage range

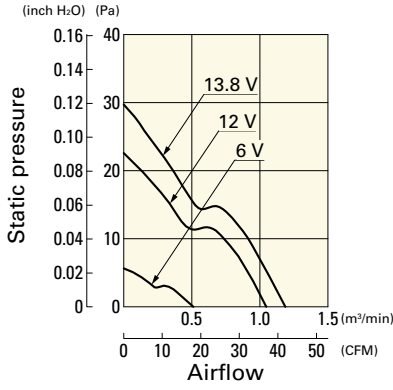

9A0912L401 With pulse sensor

Operating voltage range

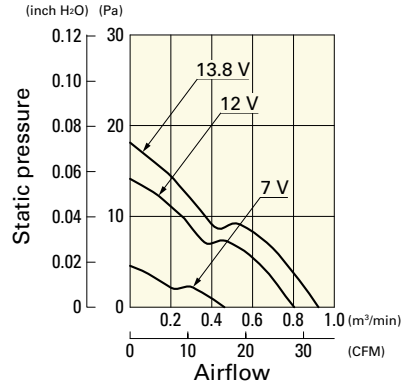

9A0924G401 With pulse sensor

Operating voltage range

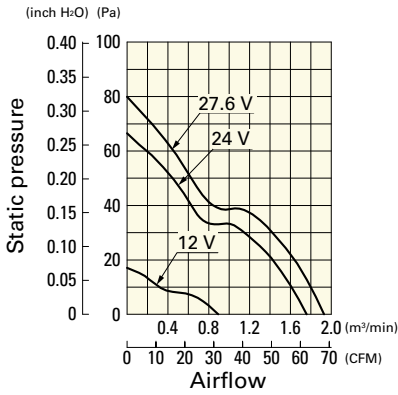

9A0924S401 With pulse sensor

Operating voltage range

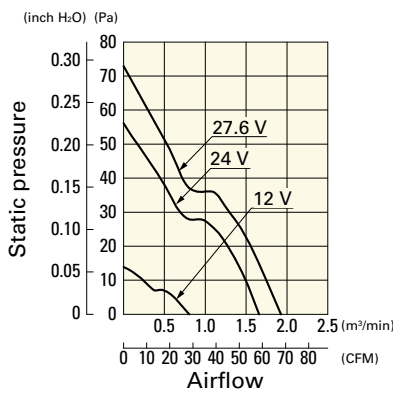

9A0924H401 With pulse sensor

Operating voltage range

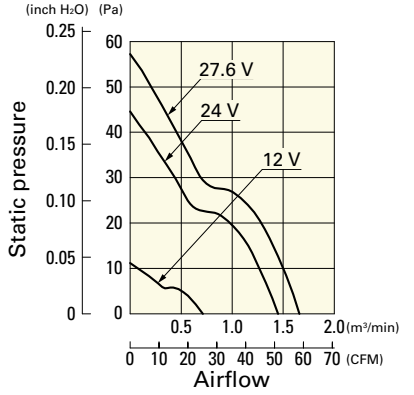

9A0924F401 With pulse sensor

Operating voltage range

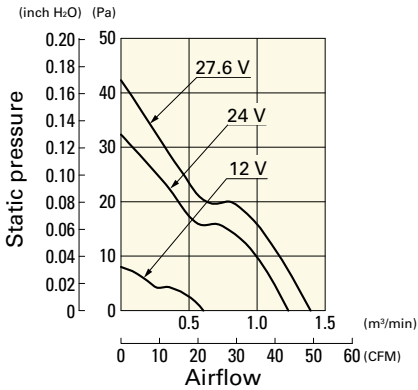

9A0924M401 With pulse sensor

Operating voltage range

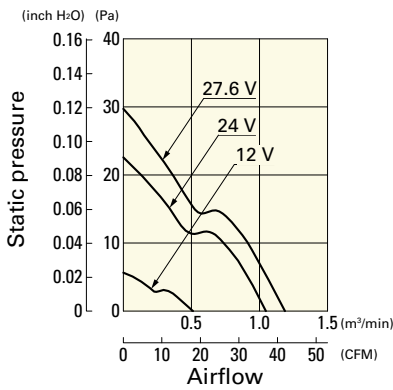

9A0924L401 With pulse sensor

Operating voltage range

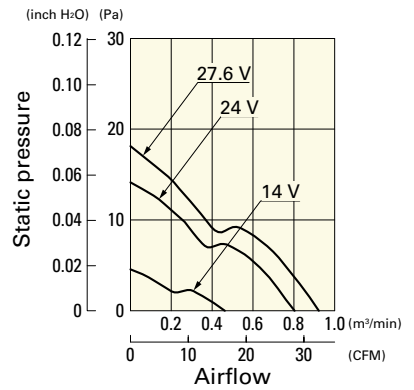

9A0948S401 With pulse sensor

Operating voltage range

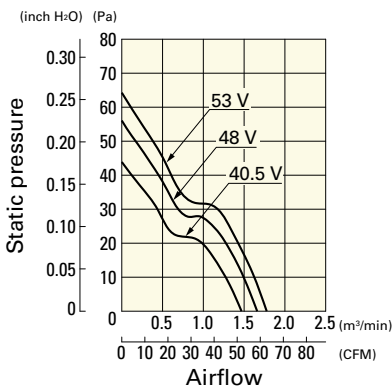

Dimensions (unit: mm) (With ribs)

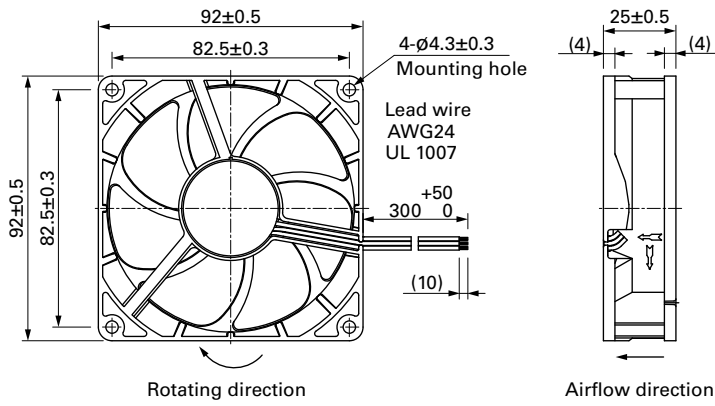

Reference Dimensions of Mounting Holes and Vent Opening (unit: mm)

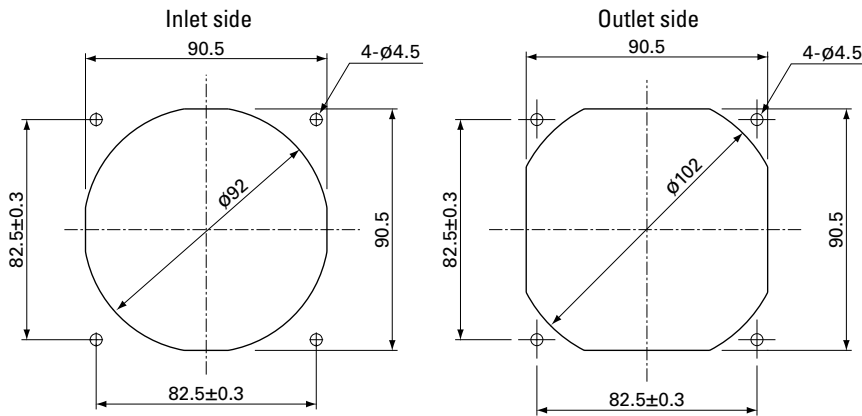

Options

Finger guards

page: p. 558

Model no.: 109-099E, 109-099H, 109-099C

Resin finger guards

page: p. 565

Model no.: 109-1001G

Resin filter kits

page: p. 566

Model no.: 109-1001F13 (13PPI), 109-1001F20 (20PPI),
109-1001F30 (30PPI), 109-1001F40 (40PPI)