



SWH Series - Switch Mode Power Supply

Table of Contents

Section	Page
Safety Precautions	3 - 5
Appearance and Meaning of Safety Warnings	4
Hazard and Caution Safety Warnings	4
Other Precautions	5
Introduction to SWH Series	6
External Dimensions	7
Model Number Description	7
Input and Output Terminals, Connections and Pin Assignments	8
Functional Description (5)	9 - 11
5.1 Input Voltage Range, Harmonic Current and Inrush Current	9
5.2 Protection Function	9
5.3 Output Voltage Variation	10
5.4 PR Signal	10
5.5 Remote ON/OFF	10
5.6 Dynamic Load	11
5.7 Others	11
Mounting, Derating and Lifetime (6)	12 - 13
6.1 Mounting	12
6.2 Derating	13
6.3 Lifetime	13
Specification and Standards	14 - 15
Disclaimer	16

Safety Precautions





Be sure to observe the precautions explained below.





1. Be sure to read "Operation Manual" and "Detailed Specifications" before using these products.
2. The products are DC stabilized power supplies with special structures created for mounting on devices. Use only for mounting on devices.
3. Although Sanken strives to improve the quality and the reliability of the products, please implement safety design of the devices under customers' responsibility not to endanger human life, health and property due to malfunction and/or failures of the products when using.
4. Sanken products listed in this publication are NOT intended to use for equipment and applications where extremely high reliability is required such as aerospace equipment, nuclear power-control stations and medical equipment, for which there is enhanced risk that the products could endanger human life or health due to malfunction and/or failures of the products (Classified III or above per GHTF, Global Harmonization Task Force, Medical Equipment Class) Sanken assumes no responsibility for any damage to any customer and/or any third party due to use of Sanken products for the such use.
5. When considering use of the products for the following equipment and applications, for which there is the risk that may heavily endanger human life or affect maintenance of public function, be sure to secure sufficient fail-safe function at customers' devices by means of multiplexing of systems and other method.
 - Electric train and elevator, etc. that may result in personal injury.
 - Vehicles and vessels, etc. that may be affected by oscillation and shock.
 - Traffic system, etc. that may exert an important influence on society and public.
 - Any other applications and equipment similar to those mentioned above.
6. Be sure to observe the items below
 - Do not disassemble, repair or modify these products.
 - Do not touch inside the power supplies because of high voltage.
 - Use the products within designated input voltage, frequency, output voltage and output current ranges.
 - Be sure to observe designated ambient environment conditions such as ambient temperature and humidity.]
 - Each power supply model has a designated method for installation and mounting. Observe installation and mounting directions.

Appearance and Meaning of Safety Warnings

In this document, the levels of safety warnings are divided into two categories, Hazard and Caution.



 Hazard	Disregarding a Hazard display and incorrectly using the product could result in death and / or serious injury.
 Caution	Disregarding a Caution display and incorrectly using the product could result in personal injury and / or physical damage.

Be sure to observe the safety precautions indicated on the product and in documentation by symbols and text. The general meaning of symbols is as follows:

	Prohibited action
	Strong warning
	Electric shock hazard
	Fire hazard

Hazard and Caution Safety Warnings

General Cautionary Notices

! Hazard	
	<ul style="list-style-type: none"> • Shock hazard • Never take off the cover • There is a high voltage circuit inside and touching it mistakenly could result in death and / or serious injury
	<ul style="list-style-type: none"> • Fire hazard • If any abnormal odour, noise, smoking or ignition arises in the product, immediately turn off the product and cut the power input to the product by opening an external circuit breaker or other means • Please contact the vendor from which the product was purchased and / or Sanken • In case of fire, use a fire extinguisher of a powder / ABC type approved for the use on electrical fires <p>Note: Never use water</p>

Other Precautions

! Caution	
	Each power supply model has a designated input / output range. Be sure to use the products within the designated input / output range.
	Be sure that the total power consumption connecting with the load does not exceed the rated output capacity per each power supply. If a power supply is used under an overload condition, it could cause fire.
	Be sure to use thick wire for input / output wiring, and that it is appropriate for the input / output power. If thin wires are used it could cause fire.
	Be sure not to use and / or store the products in temperature, humidity and dew condensation conditions beyond the ambient environmental conditions specified in the catalogue and / or operation manual, otherwise failure of the product could occur.
	When the power supply is operated in dusty conditions, please apply appropriate dust proof measures. The dust could interfere in heat dissipation and cause failure and / or fire.
	When the power supply is installed, be sure to use designated screws (paying particular attention to the screw length diameter), otherwise electric shock and / or fire could occur.
	The products are not intended for use in equipment that requires high reliability for sustaining human life. Be sure not to use the products for any particular application such as in nuclear reactor and / or power control systems, aerospace applications, special medical equipment, and so forth.
	When installing the products, be sure to connect each input terminal and output terminal without fail, otherwise malfunction and damage to the products, personal injury and fire could occur.
	Be sure not to apply any external voltage to output terminals of the products, otherwise damage to the internal devices of the products could occur.
	Be sure not to use and / or store the products in an environment with corrosive gases such as hydrogen, sulphide, sulphur dioxide and so forth, otherwise damage to the products could occur.
	When operating the products in an environment with interference from radio waves, electric fields, or magnetic fields, the products may malfunction, which could lead to failure. Be sure not to use the products under such conditions.
	Although Sanken strives to improve the quality and the reliability of the products, the customer and user are responsible to be apply safe design of their equipment before using the products.

Introduction to SWH Series

General Description

The **SWH** employs SanKen's proprietary LLC type resonant-mode and silicon carbide technology. The PSU is single output, providing 115% peak power for 10s whilst occupying a market leading position for efficiency

Features and Benefits

- High power density, high efficiency & low noise via LLC and Silicon Carbide
- Provides peak power support (115%) for 10 seconds
- World wide input (AC 85V ~ AC 265V)
- Single output, 24V / 48V
- Protection, OCP, OVP, OHP and Fan lock
- Remote On/Off, display operation status, power ready signal and AUX output (12V)



650W Output

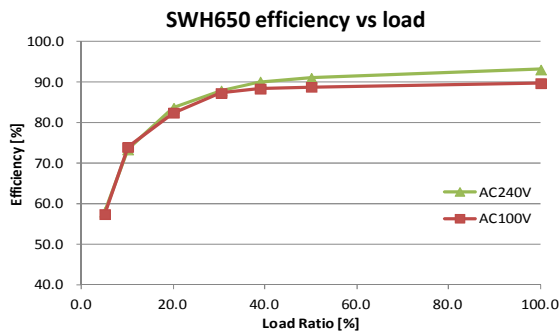

Block diagram

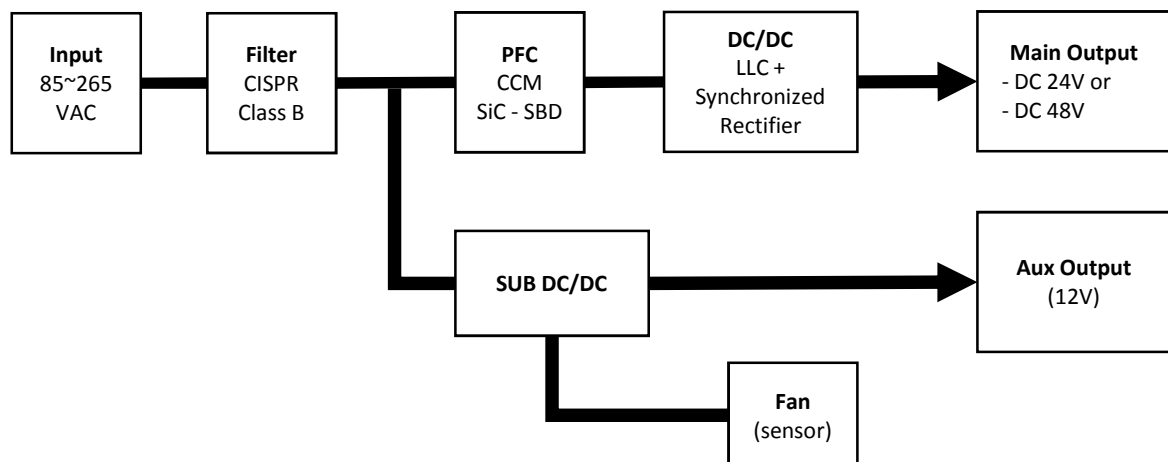

External Dimensions

Model: SWH650

Output Power: 650W

Output Voltage: 24V or 48V

Weight: 1,600g

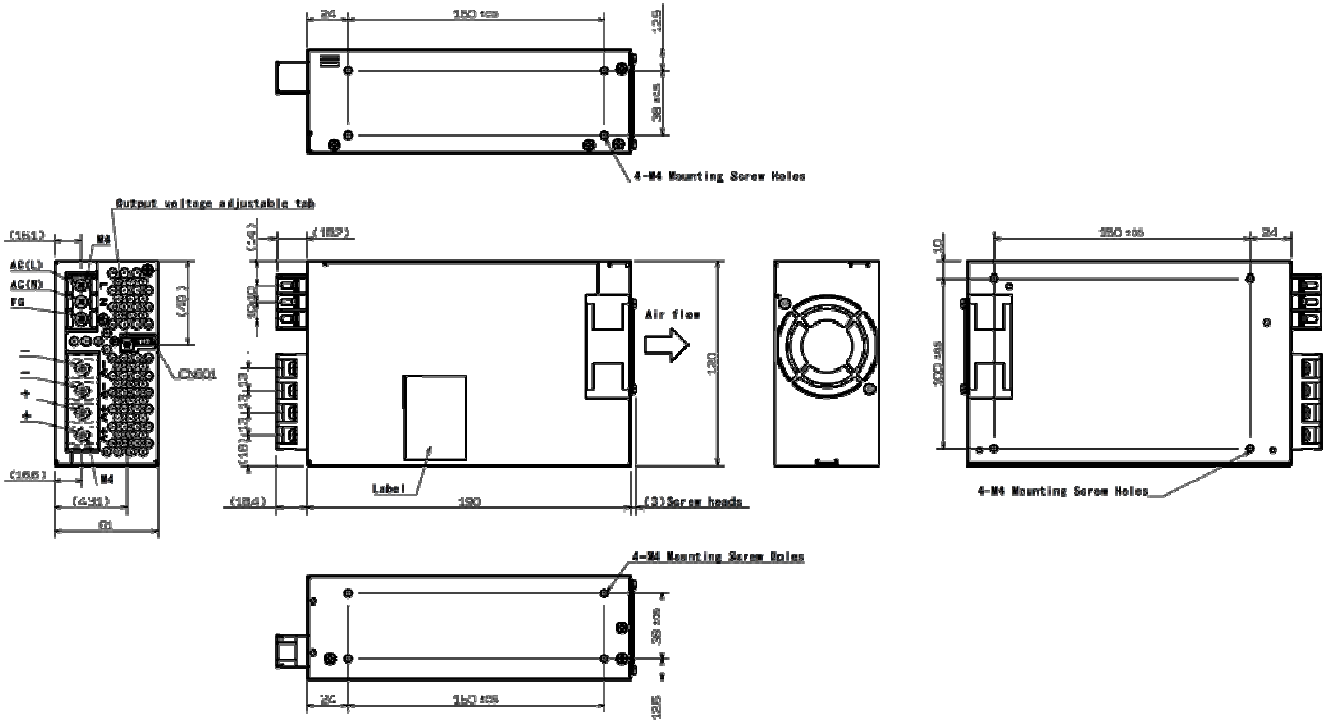

Note: Dimensions in mm

1. The tolerance is $\pm 1.0\text{mm}$ unless otherwise specified
2. Recommended fastening torque for the mounting screws: $1.2\text{N} \cdot \text{m}$ max
3. Recommended fastening torque for the input terminals: $1.6\text{N} \cdot \text{m}$ max
4. Recommended fastening torque for the output terminals: $1.4\text{N} \cdot \text{m}$ max

Model Number Description

[AAA] [NNN] -[NN]

- Nominal total rated output voltage (24V or 48V)
- Nominal total rated output wattage (650W)
- Series identifier, for example, SWH for SWH series

Input and Output Terminals, Connections and Pin Assignments

Input terminals

No.	Display	Input	Screw	Recommended fastening torque
1	L	AC In	M4	1.6N·m (16.3kgf·cm)
2	N	AC In	M4	
3	FG	FG	M4	

Be sure not to short circuit among different poles

Output terminals

No.	Display	Output	Screw	Recommended fastening torque
1	-V	Output (-)	M4	1.4N·m (14.2kgf·cm)
2	-V	Output (-)	M4	
3	+V	Output (+)	M4	
4	+V	Output (+)	M4	

Be sure not to short circuit among different poles

CN601 S8B-PHDSS (JST)

No.	Functions	
1	AUX	Auxiliary output(for remote ON/OFF)
2	GND	Auxiliary output GND
3	PR	Alarm signal output→Active H at alarming
4	Remote ON/OFF +	Remote ON/OFF input
5	Remote ON/OFF -	Remote ON/OFF GND
6	AUX-R	Auxiliary output with resistance (for remote ON/OFF)
7	Remote ON/OFF -	Remote ON/OFF GND
8	Remote ON/OFF +	Remote ON/OFF input

Be sure not to short circuit between AUX and GND



CN601 Conforming housing

Housing	PHDR-08VS	JST
Contact	SPHD-001T-PO.5 SPHD-002T-PO.5	JST

Functional Description

5.1 Input voltage range, Harmonic current and Inrush current

- Input Voltage Range
 - Input voltage range is 85V to 265 VAC
 - The rated input voltage is 100 to 240 VAC at 50/60Hz for safety standard
 - If other than specified input voltages are applied, it could cause the products to fail to operate within the specifications and/or cause permanent failure of the products
 - Contact a company sales representative for your inquiry when rectangular wave input voltage such as from UPS and Inverters are applied
- Harmonic Current
 - A harmonic current suppression circuit (active filter) is incorporated into power supply
 - Harmonic currents are suppressed in all load conditions from no load to full load
 - The input voltage range at which the harmonic current suppression circuit activates is between 85 and 264VAC
- Inrush Current
 - If a switch is used for controlling input, be sure to select a switch that can withstand the expected inrush current
 - If the AC is reapplied, be sure to wait until the supply is being switched off for more than 1 minute and then reapply AC, otherwise a large current could flow after release of the inrush preventive circuit

5.2 Protection function

- Over Current Protection (OCP)
 - Although an over current protection circuit is incorporated into the power supply, be sure not to use it under over current (overload) condition
 - When output terminals are shorted, the capacitor inside discharges instantly and this may lead to a serious accident due to sparking whilst also shortening the life time of the product
 - Once over current protection activates, the output shuts down after lowering the output voltage, then the power supply activates under intermittent over current mode lowering the average current



CAUTION:

- OCP does not necessarily guarantee complete protection against any short circuit in the output circuit
- Be sure not to short the output when using the products



CAUTION:

- Regardless of the OCP range, be sure not to exceed the total rated output current range or rated output power of the products

- Over Voltage Protection (OVP)
 - An overvoltage protection circuit is incorporated into the power supply
 - When OVP is activated, it will shut down the input and then the output will recover by reapplying input after 1 min
 - The recovery time may vary depending on input voltage and etc. when operating

Functional Description

5.3 Output voltage variation

- Output voltage adjustment
 - Rotate the adjuster clockwise to increase the output voltage and counter clockwise to decrease the output voltage
 - Be sure not to exceed the rated output power when adjusting the output voltage beyond rated output voltage

5.4 PR signal

- The alarm is incorporated into the power supply
- The PR signal is set high when input voltage into the power supply is lowered or output voltage is lowered or the internal fan is stopped

Alarm	Conditions	
PR	Good	Low (less than 0.8V and 8mA)
	Bad	35Vmax

5.5 Remote ON/OFF

- Remote ON/OFF terminal enables ON/OFF control of the output
- When using this feature, use either AUX output or an external power supply
- The output is enabled by applying voltage 4.5V to 15V (recommended current:5mA) between 4pin and 5pin, or 8pin and 7pin of remote ON/OFF terminals
- The output is disabled at either or less than 0.8V or opened
- Install a current limiting resistor if the voltage of an external power supply is high

Example

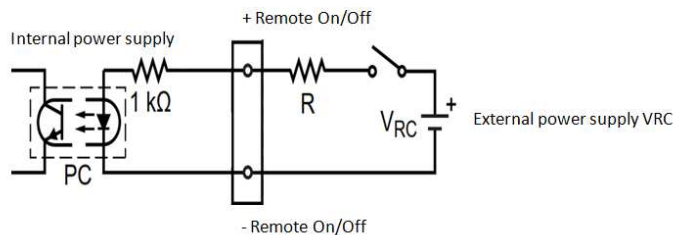

$$\text{Current limiting resistor, } R = \frac{VRC - 1 \text{ (V)} - 1 \text{ (k}\Omega) \times 5 \text{ (mA)}}{5 \text{ (mA)}}$$

(PC's forward drop = 1V)

- Use twisted or shielded wires to prevent noise induction
- The remote ON/OFF control circuit is insulated from the input, output and FG

Functional Description

5.6 Dynamic load

- The peak current load occurs within 10 seconds (Duty 35% or less)
- This series can also be used with dynamic (pulse) load
- During dynamic operation, use the supply with the output current's RMS value equal to or less than the rated current
- If output voltage is adjusted by output voltage adjuster, be sure not to exceed both peak load current and maximum peak power specified

Example

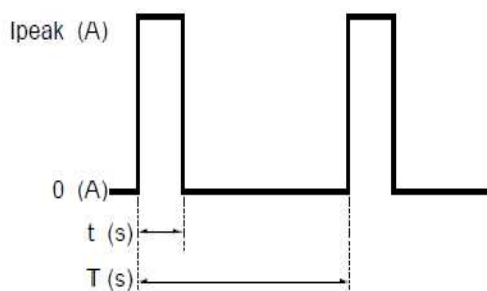

$$\text{Output Current RMS Value, } I_{\text{rms}} = \sqrt{\frac{t(s)}{T(s)}} \times I_{\text{OUT(PEAK)}} \text{ (A)}$$

t = peak current time
T = current period

$I_{\text{OUT(PEAK)}}$ is peak output current amplitude

5.7 Others

- Increase voltage gradually when conducting withstand voltage test at incoming inspection and etc.
- Upon completion of test, decrease voltage gradually when voltage is shut down

Mounting, Derating and Lifetime

6.1 Mounting

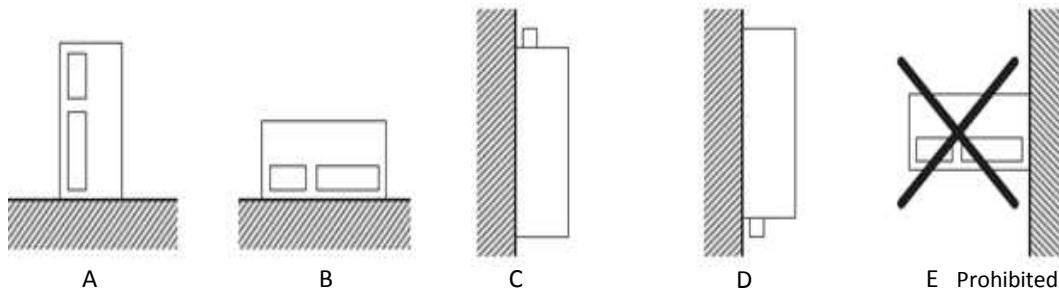

- Be sure the screw insertion length for mounting the supply is kept within 6mm from outside chassis in order to secure insulation distance from internal components

- Fixing screw for mounting

Screw	Recommended tightening torque
M4	1.2N·m (12.3kgf·cm)

* JIS B 0205

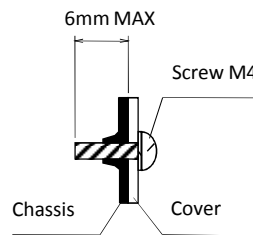

- For securing safety, be sure to ground earth terminal in proper way
- The products described in this manual are built in type power supplies
- Be sure to use the power supply only for installation in equipment in the way to prevent from danger of electric shock since there is high voltage circuit inside
- When the power supply is operated in dusty conditions, dust proofing measures may be required
- If air flow is restricted, the cooling effect may be weakened and the output may stop
- If rotational speed of the fan is lowered or the fan is stopped, output may be stopped due to overheat protection
- Be sure to conduct routine inspection of the fan in order to improve reliability since lifetime expectancy of the fan is varied depending on use environment and use conditions
- The products are with discharge type fan incorporated inside and forced air cooling type
- Be sure to secure more than 50mm space at input/output side and fan side when installing as described below
- If cooling is not made effectively, output may be stopped.

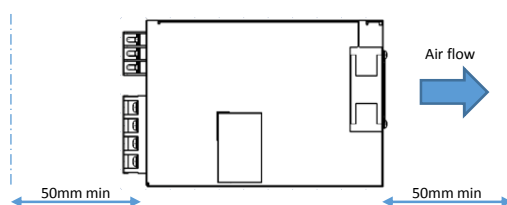

Mounting, Derating and Lifetime

6.2 Derating

- Derating per ambient temperature

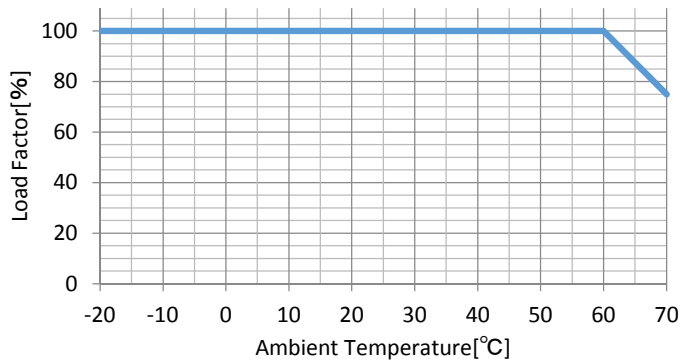

6.3 Lifetime

- Lifetime expectancy

Ave. ambient temperature(annum)	Output Load Factor	
	50%	100%
Less than Ta=50°C	10 years	10 years
Less than Ta=60°C	7 years	7 years

* Assumption: Routine inspection of the fan is conducted.

Specification and Standards

Model SWH650

Parameter		SWH650-24	SWH650-48	
Input Condition	Rated Input Voltage	100 to 240VAC		
	Allowable Input Voltage	85 to 265VAC		
	Input Current (typ)	7.3A (VIN = 100V) / 3.0A (VIN = 240V)		
	Rated Frequency	50 / 60 Hz		
	Allowable Frequency Range	47 to 63 Hz		
	Efficiency (typ)	88% (VIN = 100V) / 91% (VIN = 240V)		
	Inrush Current (typ) *1, 2	20A / 40A		
	Leakage Current (max) *9	0.35 mA (VIN = 100V) / 0.5mA (Vin=230V)		
Output Conditions	Rated Output Voltage	24V	48V	
	Output Voltage Variation *8	21.6 to 26.4V	43.2 to 52.8V	
	Rated Output Current *10	27A	13A	
	Maximum Peak Current *11	31A	15A	
	Rated Output Power	648W	627W	
	Peak Output Power	744W	720W	
	Constant Voltage Accuracy *3	±3%		
	Ripple *4	120mVp-p(max) for 0 to 60°C	150mVp-p(max) for 0 to 60°C	
		180mVp-p(max) for -20 to 0°C	400mVp-p(max) for -20 to 0°C	
	Ripple Noise *4	300mVp-p(max) for 0 to 60°C	200mVp-p(max) for 0 to 60°C	
		480mVp-p(max) -20 to 0°C	500mVp-p(max) -20 to 0°C	
Output Holding Time (min) *1	20msec typ (AC100V Io=100%)			
Additional Functions	Over current Protection	Detection above 116% of rated current (automatic recovery)		
	Over voltage Protection *5	27V to 35V	54V to 61V	
	Operations Display	LED Display (Green)		
	Others	Remote ON/OFF, AUX for remote ON/OFF, PR(Power Ready) signal		
Environmental Conditions	Operating Temperature Range *6	-20°C to +70°C (with derating per temperature)		
	Storage Temperature Range	-20°C to 75°C		
	Operating Humidity Range	20% to 90% RH (no dew condensation)		
	Storage Humidity Range	20% to 90% RH (no dew condensation)		
	Cooling Requirements	Forced air cooling		
	Vibration Resistance	Vibration Frequency	10 to 55 Hz	
		Sweep Time	3 minutes	
		Acceleration	19.6 m / s ² (2 G)	
		Vibration Detection	x, y, z	
		Vibration Time	One hour in each of three directions	
	Shock Resistance	196.1m/s ² (20G)		
Installation Conditions	Derating may be required due to mounting orientation			

Continued on next page

Continued from the previous page

Model SWH650

Parameter			Value
Insulation 7	Insulation Withstand Voltage	Input-Output	4000 VAC one minute (leakage current 10mA or less)
		Input-FG	2000 VAC one minute (leakage current 10mA or less)
		Output-FG	500 VAC one minute (leakage current 10mA or less)
	Insulation Resistance	Input-Output	100 MΩ (measured with 500 VDC)
		Input-FG	
		Output-FG	
Others	Input & Output type		Terminal type
	External dimensions		120(W) × 61(H) × 190(D) mm without terminals
	Weight		1.6Kg max
	Safety Standards		UL60950-1, C-UL(CSA60950-1), EN60950-1. Designed to meet EN50178 and PSE
	Conducted Emissions	Designed to meet FCC Class B	
		Designed to meet EN55022 Class B, CISPR22 Class B, EN55011 Class B	
		Designed to meet VCCI Class B	
	EMC		Designated to meet harmonic current IEC61000-3-2
RoHS		RoHS compliant	

- Specified under rated input/output conditions at an ambient temperature of 25°C.
- More current above noted values may flow at restart (ambient temperature of 25°C).
- The constant voltage accuracy is measured with a static input variation, a static load variation, a time drift, and an ambient temperature variation.
- Ripple noise is measured with a 20MHz oscilloscope using a 1:1 probe.
Output conditions are measured at a point 15 cm from the output connector, with a 22uF electrolytic capacitor and 0.1uF film capacitor connected to that point.
- Reset is performed by reapplying input voltage.
- Refer to output derating curve.
- Insulation conditions are specified at normal temperature and humidity.
- When adjusting the output voltage, be sure not to exceed the output voltage variation range, the rated output current and the rated output power.
- Measured at 60Hz Io=100% as per IEC60950-1 and PSE.
- Start-up is to be performed at less than rated output current.
Maximum peak current shall be within 10 seconds and under duty 35%.
Be sure effective current shall not exceed the rated output current and the rated output power.
- When applying peak current, be sure not to exceed the maximum peak current.
When the output voltage exceeding the rated output voltage, the maximum peak current is limited by the peak output power.

Disclaimer

Sanken reserves the right to make, from time to time, such departures from the detail specifications as may be required to permit improvements in the performance, reliability, or manufacturability of its products. Therefore, the user is cautioned to verify that the information in this publication is current before placing any order.

When using the products described herein, the applicability and suitability of such products for the intended purpose shall be reviewed at the users' responsibility.

Although Sanken undertakes activity to enhance the quality and reliability of its products, the occurrence of failure and defect of semiconductor products at a certain rate is inevitable.

Users of Sanken products are requested to take, at their own risk, preventative measures including safety design of the equipment or systems against any possible injury, death, fires or damages to society due to device failure or malfunction.

Sanken products listed in this publication are designed and intended for use as components in general-purpose electronic equipment or apparatus (home appliances, office equipment, telecommunication equipment, measuring equipment, etc.).

Their use in any application requiring radiation hardness assurance (e.g., aerospace equipment) is not supported.

When considering the use of Sanken products in applications where higher reliability is required (transportation equipment and its control systems or equipment, fire- or burglar-alarm systems, various safety devices, etc.), contact a company sales representative to discuss and obtain written confirmation of your specifications.

The use of Sanken products without the written consent of Sanken in applications where extremely high reliability is required (aero- space equipment, nuclear power-control stations, life-support systems, etc.) is strictly prohibited.

The information included herein is believed to be accurate and reliable. Application and operation examples described in this publication are given for reference only and Sanken assumes no responsibility for any infringement of industrial property rights, intellectual property rights, or any other rights of Sanken or any third party that may result from its use. The contents in this document must not be transcribed or copied without Sanken's written consent.