



**AC/DC Converter**  
**Non-Isolation Buck Converter**  
**PWM method 10 W 14 V**  
**BM2P141X Reference Board**

**User's Guide**

## <High Voltage Safety Precautions>

◇ Read all safety precautions before use

Please note that this document covers only the BM2P141X evaluation board (BM2P141X-EVK-001) and its functions. For additional information, please refer to the datasheet.

**To ensure safe operation, please carefully read all precautions before handling the evaluation board**



Depending on the configuration of the board and voltages used,

**Potentially lethal voltages may be generated.**

Therefore, please make sure to read and observe all safety precautions described in the red box below.

### Before Use

- [1] Verify that the parts/components are not damaged or missing (i.e. due to the drops).
- [2] Check that there are no conductive foreign objects on the board.
- [3] Be careful when performing soldering on the module and/or evaluation board to ensure that solder splash does not occur.
- [4] Check that there is no condensation or water droplets on the circuit board.

### During Use

- [5] Be careful to not allow conductive objects to come into contact with the board.
- [6] **Brief accidental contact or even bringing your hand close to the board may result in discharge and lead to severe injury or death.**

**Therefore, DO NOT touch the board with your bare hands or bring them too close to the board.**

In addition, as mentioned above please exercise extreme caution when using conductive tools such as tweezers and screwdrivers.

- [7] If used under conditions beyond its rated voltage, it may cause defects such as short-circuit or, depending on the circumstances, explosion or other permanent damages.
- [8] Be sure to wear insulated gloves when handling is required during operation.

### After Use

- [9] The ROHM Evaluation Board contains the circuits which store the high voltage. Since it stores the charges even after the connected power circuits are cut, please discharge the electricity after using it, and please deal with it after confirming such electric discharge.
- [10] Protect against electric shocks by wearing insulated gloves when handling.

This evaluation board is intended for use only in research and development facilities and should be handled **only by qualified personnel familiar with all safety and operating procedures.**

We recommend carrying out operation in a safe environment that includes the use of high voltage signage at all entrances, safety interlocks, and protective glasses.

## AC/DC Converter

### Non-Isolation Buck Converter PWM method Output 10 W 14 V

# BM2P141X Reference Board

## BM2P141X-EVK-001

The BM2P141X-EVK-001 evaluation board outputs 14 V voltage from the input of 90 Vac to 264 Vac. The output current supplies up to 0.715 A. The BM2P141X which is PWM method DC/DC converter IC built-in 650 V MOSFET is used.

The BM2P141X contributes to low power consumption by built-in a 650 V starting circuit. Built-in current detection resistor realizes compact power supply design. Current mode control imposes current limitation on every cycle, providing superior performance in bandwidth and transient response. The switching frequency is 65 kHz in fixed mode. At light load, frequency is reduced and high efficiency is realized. Built-in frequency hopping function contributes to low EMI. Low on-resistance 1.5  $\Omega$  650 V MOSFET built-in contributes to low power consumption and easy design.

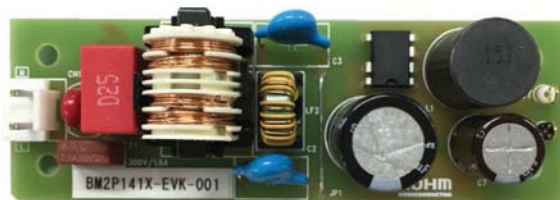

Figure 1. BM2P141X-EVK-001

## Electronics Characteristics

Not guarantee the characteristics, is representative value.

Unless otherwise noted :  $V_{IN} = 230 \text{ Vac}$ ,  $I_{OUT} = 0.5 \text{ A}$ ,  $T_a: 25 \text{ }^\circ\text{C}$

Parameter	Min	Typ	Max	Units	Conditions
Input Voltage Range	90	230	264	Vac	
Input Frequency	47	50/60	63	Hz	
Output Voltage	12.6	14.0	15.4	V	
Maximum Output Power	-	-	10.0	W	$I_{OUT} = 0.715 \text{ A}$
Output Current Range (NOTE1)	0.000	0.500	0.715	A	
Stand-by Power	-	150	-	mW	$I_{OUT} = 0 \text{ A}$
Efficiency	80.0	83.7	-	%	
Output Ripple Voltage (NOTE2)	-	76	-	mVpp	
Operating Temperature Range	-10	+25	+65	$^\circ\text{C}$	

(NOTE1) Please adjust operating time, within any parts surface temperature under 105  $^\circ\text{C}$

(NOTE2) Not include spike noise

**Operation Procedure**

1. Operation Equipment

- (1) AC Power supply 90 Vac~264 Vac, over 20W
- (2) Electronic Load capacity 0.715 A
- (3) Multi meter

2. Connect method

- (1) AC power supply presetting range 90~264 Vac, Output switch is off.
- (2) Load setting under 0.715 A. Load switch is off.
- (3) AC power supply N terminal connect to the board AC (N) of CN1, and L terminal connect to AC(L).
- (4) Load + terminal connect to VOUT, GND terminal connect to GND terminal
- (5) AC power meter connect between AC power supply and board.
- (6) Output test equipment connects to output terminal
- (7) AC power supply switch ON.
- (8) Check that output voltage is 14 V.
- (9) Electronic load switch ON
- (10) Check output voltage drop by load connect wire resistance

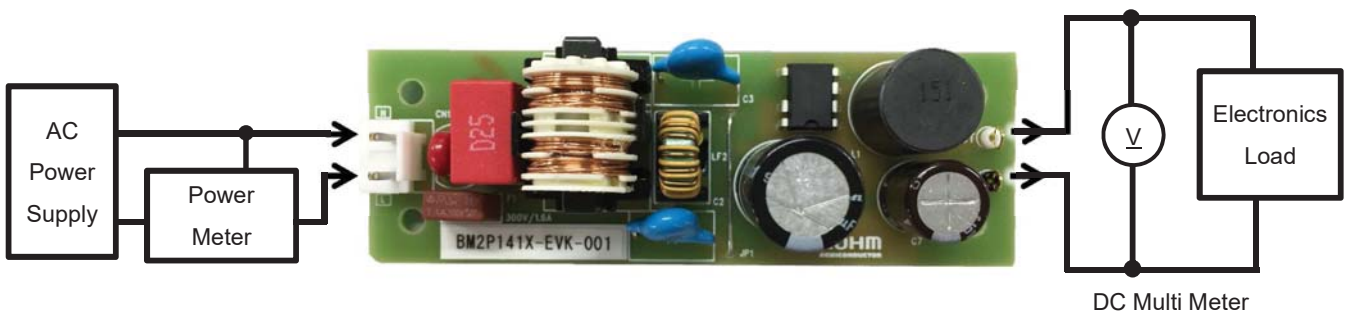

CN1 : from the top ①:AC (L), ②:AC (N)

Figure 2. Connection Circuit

**Deleting**

Maximum Output Power  $P_o$  of this reference board is 10.0 W. The derating curve is shown on the right. If ambient temperature is over 40°C, Please adjust load continuous time by over 105 °C of any parts surface temperature.

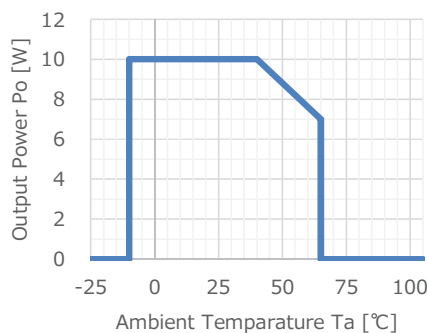

Figure 3. Temperature Derating curve

Application Circuit

$V_{IN} = 90 \sim 264 \text{ Vac}$ ,  $V_{OUT} = 14 \text{ V}$

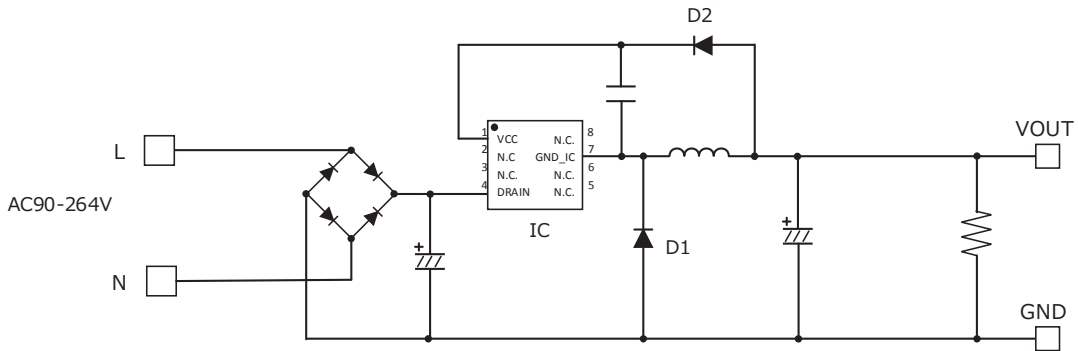

Figure 4. BM2P141X-EVK-001 Application Circuit

The BM2P141X is non-insulation method without opto-coupler and feeds back the VCC voltage to 14.0 V typ. This VCC voltage is the voltage between the VCC pin and the GND\_IC pin.

The output voltage VOUT is defined by the following equation.

$$V_{OUT} = V_{CNT} + V_{FD2} - V_{FD1}$$

$V_{CNT}$ : VCC Control Voltage

$V_{FD1}$ : Forward Voltage of diode D1

$V_{FD2}$ : Forward Voltage of diode D2

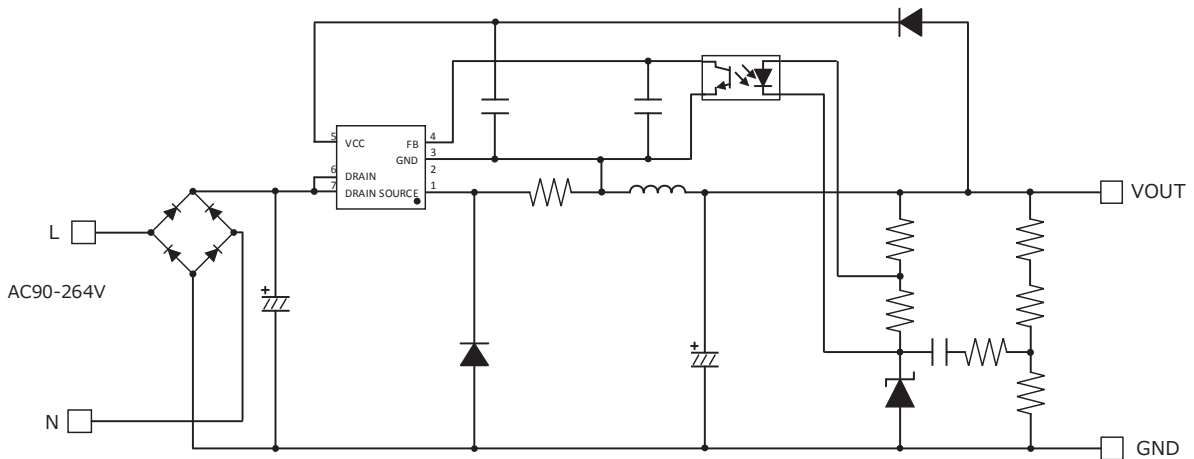

Figure 5. General Buck converter application circuit

Compared to the general Buck converter as shown above, the number of parts is reduced because the feedback circuit is not required. However, the output voltage may rise at light load because the VCC voltage and the output voltage that are fed back are different. In that case, please put a resistance on the output terminal and lower the output voltage.

**BM2P141X Overview**

**Feature**

- PWM Frequency=65 kHz
- PWM current mode control
- Switching frequency jitter
- Burst function around light load
- 650 V Starter
- 650 V Super-Junction Power MOSFET
- VCC Under voltage detection
- VCC Over voltage detection
- Cycle by cycle current limiter
- Soft Start function

**Key specifications**

- Operation Voltage Range: VCC: 12.00 V ~ 15.12 V  
DRAIN 650 V(Max)
- Circuit Current(ON): 0.85 mA(Typ)
- Circuit Current (Burst mode): 0.45 mA(Typ)
- Switching Frequency: 65 kHz(Typ)
- Operating Temperature: -40 °C ~ +105 °C
- MOSFET R-ON: 1.5 Ω(Typ)

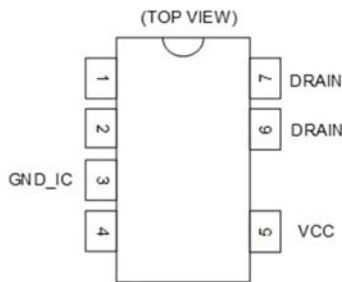

Figure 6. Block Diagram

**Dimension**

DIP7K

W(Typ) x D(Typ) x H(Max)

9.20 mm x 6.35 mm x 4.30 mm

Pitch 2.54 mm



Figure 7. DIP7K Package

Table 1. BM2P141X PIN description

No.	Name	I/O	Function	ESD Diode	
				VCC	GND
1	-	-	-	-	-
2	-	-	-	-	-
3	GND_IC	I/O	GND	✓	-
4	-	-	-	-	-
5	VCC	I	Vcc	-	✓
6	DRAIN	I/O	MOSEFET DRAIN	-	✓
7	DRAIN	I/O	MOSEFET DRAIN	-	✓

**Design Overview**

1 Important parameter

- $V_{IN}$  : Input Voltage Range AC 90 V ~ 264 Vac (DC 100 V ~ 380 V)
- $V_{OUT}$  : Output Voltage DC 14 V
- $I_{OUT(Typ)}$  : Constant Output Current 0.5 A
- $I_{OUT(Max)}$  : Maximum Output Current 0.715 A
- $f_{SW}$  : Switching Frequency Min:60 kHz, Typ:65 kHz, Max:70 kHz
- $I_{peak(Min)}$  : Over Current Detection Current Min:1.8 A, Typ:2.0 A, Max:2.2A

2 Coil Selection

2.1 Determining Coil Inductance

The switching operation mode determines the L value so that it becomes as discontinuous mode (DCM) as possible. In the continuous mode (CCM), reverse current in trr of the diode flows, which leads to an increase in power loss of diode. Furthermore, this reverse current becomes the peak current when the MOSFET is ON, and the power loss of the MOSFET also increases. The constant load current  $I_{OUT(Typ)}$ : 0.5 A, the peak current  $I_L$  flowing through the inductor is:

$$I_L = I_{OUT(Typ)} \times 2 = 1.0 \quad [A]$$

It tends to be in continuous mode (CCM) when the input voltage drops.

Calculate with input voltage minimum voltage 100 Vdc with 20% margin and  $V_{IN(Min)} = 80$  Vdc.

From the output voltage  $V_{OUT}$ : 14 V and the diode  $V_F$ : 1 V, Calculate the maximum value of Duty: Duty (Max).

$$Duty(max) = \frac{V_{OUT} + V_F}{V_{IN(Min)}} = 0.188$$

From the minimum switching frequency  $f_{SW(Min)} = 60$  kHz, Calculate on time  $t_{on(Max)}$

$$t_{on(Max)} = \frac{Duty(Max)}{f_{SW(Min)}} = 3.125 \quad [\mu sec]$$

Calculate L value to operate in discontinuous mode.

$$L < t_{on(Max)} \times \frac{V_I(Min) - V_o}{I_L} = 206.3 \quad [\mu H]$$

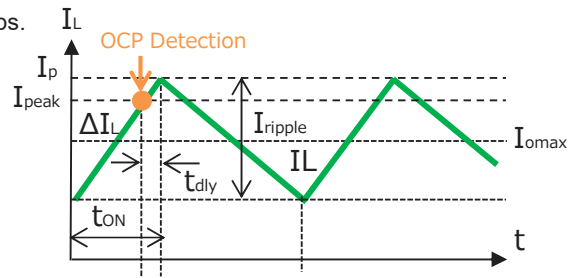

Figure 8. Coil current waveform at OCP detection

## 2.1 Determining Coil Inductance – Continued

Also, calculate L value so that the overcurrent detection becomes maximum load current  $I_{OUT}$ : 715 mA or more. Overcurrent detection is calculated by the current flowing through the MOSFET when operating in continuous mode at the minimum switching frequency  $f_{SW}(\text{Min}) = 60$  kHz. When the current flowing through the MOSFET ( $\neq$  the coil current at switching ON) exceeds the minimum value  $I_{peak}(\text{Min})$ : 1.8 A of the overcurrent detection current, the MOSFET is turned OFF. Since a delay of approximately  $tdly = 0.1$   $\mu\text{sec}$  occurs, in reality, the peak current exceeds the  $I_{peak}$  value and the peak current becomes  $I_p$ . The peak current  $I_p$  is obtained by setting the current slope at switching ON to  $\Delta I_L$ ,

$$I_p = I_{peak} + \Delta I_L \times tdly$$

$$I_p = I_{peak} + \frac{V_{IN} - V_O}{L} \times tdly$$

Calculate the output current  $I_o$  (LIM) at overcurrent detection by securing a margin of 10% from the maximum load current of 715 mA, and setting it as 787 mA.

$$I_{OUT}(LIM) = I_p - \frac{I_{ripple}}{2} > I_{OUT}(Max)$$

Calculate the minimum value of the L value of the coil. From the above formula,

$$L > \frac{\{2 \times tdly \times f_{SW}(\text{Min}) - (V_{OUT} + V_F)\} \times (V_{IN}(\text{Min}) - V_{OUT})}{2 \times f_{SW}(\text{Min}) \times (I_{OUT}(Max) - I_{peak}(\text{Min})) \times V_I(\text{Min})} = 95.0 \quad [\mu\text{H}]$$

Therefore, the inductance value of the coil is discontinuous mode when the rated current  $I_o$  (Typ) is 0.5 A, and in order to detect the overcurrent of the maximum load current  $I_o$  (Max): 0.715 A or more, the condition of 95.0  $\mu\text{H}$  to 206.3  $\mu\text{H}$ , A coil of 150  $\mu\text{H}$  is selected.

## 2.2 Inductor Current Calculation

Calculate the maximum peak current of the inductor. The condition where the peak current is maximized is when the input voltage is the maximum voltage  $V_{IN}(\text{Max})$ : 380 V, the maximum load current  $I_o$  (Max): 0.715 A, and the switching frequency is 60 kHz at the minimum. The ripple current  $I_{ripple}$  of the coil is given by the following formula.

$$I_{ripple} = \frac{di}{dt} \times t_{ON} = \frac{\{V_{IN}(\text{Max}) - (V_{OUT} + V_F)\}}{L} \times \frac{(V_{OUT} + V_F)}{V_{IN}(\text{Max}) \times f_{SW}(\text{Min})}$$



## 2.2 Inductor Current Calculation -Continued

When it is applied to the formula of the peak current,

$$I_p = I_{OUT}(Max) + \frac{I_{ripple}}{2} = I_O + \frac{\{V_{IN}(Max) - (V_{OUT} + V_F)\}(V_{OUT} + V_F)}{2 \times L \times V_{IN}(Max) \times f_{SW}(Min)} = 1.52 \quad [A]$$

Select a coil with an allowable current of 1.52 A or more.

In this EVK, we use inductance value: 150  $\mu$ H, rated: 1.9 A product.

Radial inductor (closed magnetic circuit type) Core size DR09 x 11 series

Product: XF1501Y-151

Manufacturer: ALPHA TRANS CO., LTD

〒541-0059 Senbanishi KID Bldg 7F, 4-4-11, Bakurou-machi, Chuo-ku, Osaka

<http://www.alphatrans.jp/>

## 3 Diode Selection

### 3.1 Flywheel Diode : D1

Flywheel diode uses fast diode (fast recovery diode). The reverse voltage of the diode is  $V_{IN}$  (Max): 380 V when the output voltage at startup is 0 V. Consider the derating and select 600 V diode. The condition where the effective current of the diode is maximized is when the input voltage is the maximum voltage  $V_{IN}$  (Max): 380 V, the maximum load current  $I_O$  (Max): 0.715 A, and the switching frequency is 60 kHz at the minimum.

$$Duty = \frac{V_{OUT} + V_F}{V_{IN}(Max)} = 3.9 \quad [\%]$$

The average current  $I_D$  of the diode is calculated from the peak current  $I_p$ : 1.52 A by the following formula

$$I_D(rms) = I_p \times \sqrt{\frac{1 - Duty}{3}} = 0.860 \quad [A]$$

Select the rated current of 0.860 A or more.

In fact, we used RFN5BM6S of 5 A / 600 V product as a result of mounting the board and considering the parts temperature.

### 3.2 VCC Rectifier Diode : D1

Rectifier diodes are used for diodes to supply VCC. The reverse voltage applied to the diode is  $V_{IN}$  (Max): 380 V. Consider the derating and select 600 V diode. Because the current flowing to the IC is small enough, we use the 0.2 A / 600 V RRE02VSM6S.

Design Overview – Continued

4 Capacitor Selection

4.1 Input Capacitor : C4

The input capacitor is determined by input voltage  $V_I$  and output power  $P_{OUT}$ . As a guide, for an input voltage of 90 to 264 Vac,  $2 \times P_{OUT}$  [W]  $\mu$ F. For 176 to 264 Vac, set  $1 \times P_{OUT}$  [W]  $\mu$ F. Since the output power  $P_{OUT} = 10$  W,  $22 \mu$ F / 450 V is selected at 20  $\mu$ F or more.

4.2 VCC Capacitor : C6

The VCC capacitor  $C_{VCC}$  is required for stable operation of the device and stable feedback of the output voltage. A withstand voltage of 25 V or more is required, and 1.0  $\mu$ F to 4.7  $\mu$ F is recommended. 2.2  $\mu$ F / 50 V is selected.

4.3 Output Capacitor : C7, C8

For the output capacitor, select output voltage  $V_O$  of 25 V or more in consideration of derating. For C7 electrolytic capacitors, capacitance, impedance and rated ripple current must be taken into consideration.

The output ripple voltage is a composite waveform generated by electrostatic capacity:  $C_{out}$ , impedance: ESR when the ripple component of inductor current:  $\Delta I_L$  flows into the output capacitor and is expressed by the following formula.

$$\Delta V_{ripple} = \Delta I_L \times \left( \frac{1}{8 \times C_{out} \times f_{sw}} \right) + ESR$$

The inductor ripple current,

$$\Delta I_L = 2 \times \{I_p - I_{OUT(max)}\} = 2 \times (1.52 - 0.715) = 1.61 \quad [A]$$

For this EVK, we use electrostatic capacity: 680  $\mu$ F, ESR: 0.049  $\Omega$ , and the design value of output ripple voltage is less than 100 mV.

$$\Delta V_{ripple} = \Delta I_L \times \left\{ \left( \frac{1}{8 \times C_{out} \times f_{sw}} \right) + ESR \right\} = 1.61 \times \left\{ \left( \frac{1}{8 \times 680 \mu \times 65k} \right) + 0.049 \right\} = 83.4 \quad [mV]$$

Next, check whether the ripple current of the capacitor satisfies the rated ripple current.

Inductor ripple current RMS conversion,

$$I_L[rms] = \Delta I_L \times \sqrt{\frac{1}{3}} = 0.93 \quad [A]$$

The ripple current of the capacitor,

$$I_C[rms] = \sqrt{I_L^2 - I_{OUT}^2} = \sqrt{0.93^2 - 0.715^2} = 0.59 \quad [A]$$

#### 4.3 Output Capacitor C7, C8 – Continued

Select a rated current of 0.59 A or more.

The output capacitor C7 used a rated ripple current of 1.24 A at 680  $\mu\text{F}$  / 25 V.

C8 has added a 0.1  $\mu\text{F}$  ceramic capacitor to reduce switching noise.

#### 5 Resistor Selection

##### 5.1 Discharge Resistor : R1,R2,R3

The resistor is for discharging X - Capacitor (C1). Considering withstand voltage, 3 pcs of chip resistance of ROHM product MCR18 (200 V withstand voltage) are connected in series. 220 k $\Omega$  is used in 3 pcs in series so that it becomes 45 V or less after 1 second after turning off the power supply.

##### 5.2 Bleeder Resistor : R4

Because it is indirectly fed back to the output voltage, the output voltage increases at light load. This board uses bleeder resistance for its improvement. Reducing the resistance value improves the rise in the output voltage of the light load, but increases the power loss. 10 k $\Omega$  / 0.25 W is used.

#### 6 EMI Filter Selection

As a measure against "Conducted Emission", Input filter is composed of X-Capacitor: C1 and common mode filter LF1.

X-Capacitor uses 0.22  $\mu\text{F}$  / X 2. The common mode filter uses 13 mH (Min) / 1 A.

As a measure against "Radiated Emission", Input filter is composed of Y-Capacitor: C2, C3 and a common mode filter LF2.

Y - Capacitor uses 2200 pF / Y1 and connects the midpoint to the output capacitor so that high frequency noise is not propagated from the input. Moreover, the common mode filter uses 60  $\mu\text{H}$  (Min) / 1 A with good characteristics of the 100 MHz band. If "Radiated Emission" does not have a problem in the state that it is loaded in the set, C2, C3, LF2 are unnecessary.

Performance Data

Constant Load Regulation

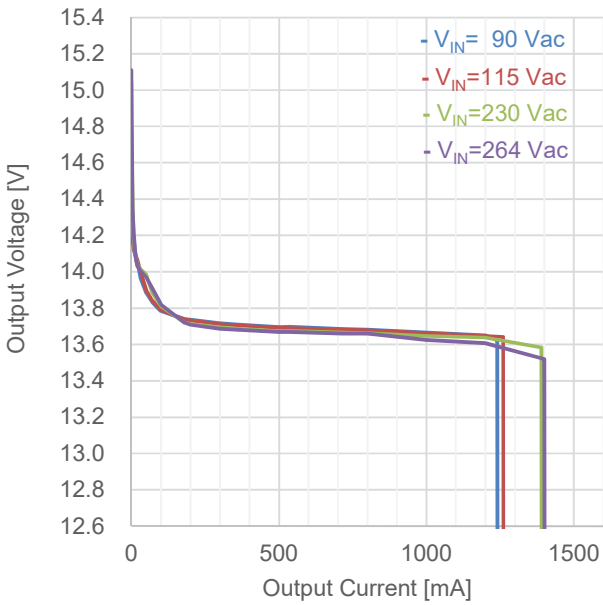

Figure 8. Load Regulation ( $I_{OUT}$  vs.  $V_{OUT}$ )

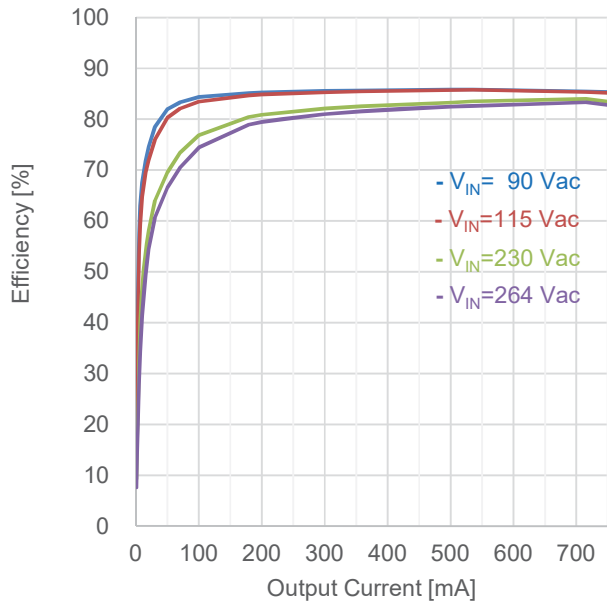

Figure 9. Load Regulation ( $I_{OUT}$  vs. Efficiency)

Table 2. Load Regulation ( $V_{IN}=115$  Vac)

$I_{OUT}$	$V_{OUT}$	Efficiency
179 mA	13.737 V	84.64 %
358 mA	13.705 V	85.45 %
536 mA	13.690 V	85.77 %
715 mA	13.681 V	83.36 %

Table 3. Load Regulation ( $V_{IN}=230$  Vac)

$I_{OUT}$	$V_{OUT}$	Efficiency
179 mA	13.720 V	80.47 %
358 mA	13.687 V	82.52 %
536 mA	13.674 V	83.48 %
715 mA	13.665 V	84.01 %

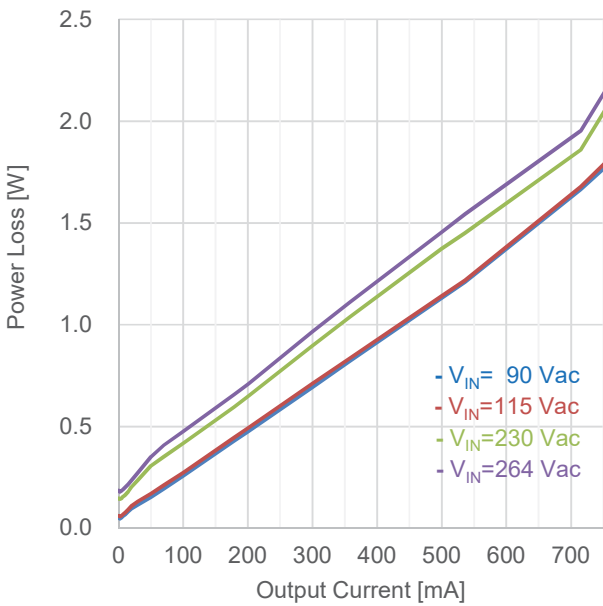

Figure 10. Load Regulation ( $I_{OUT}$  vs.  $P_{LOSS}$ )

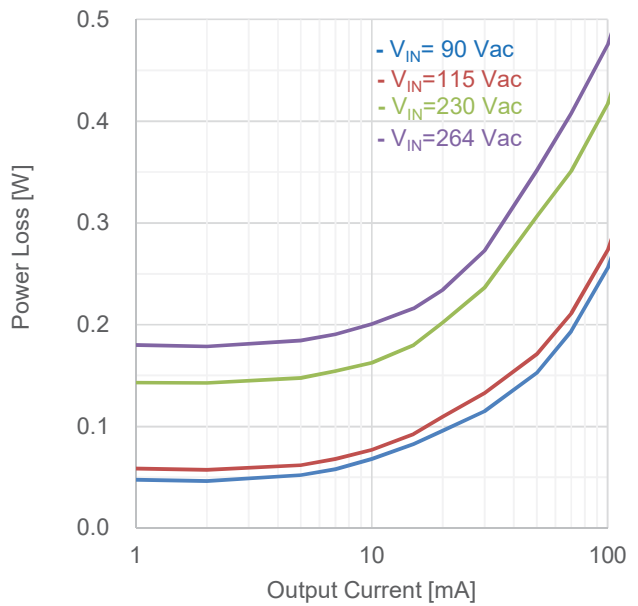

Figure 11. Load Regulation ( $I_{OUT}$  vs.  $P_{LOSS}$ )

Performance Data -Continued

Table 4. Load Regulation :  $V_{IN}=90$  Vac

$V_{IN}$ [Vac]	$P_{IN}$ [W]	$V_{OUT}$ [V]	$I_{OUT}$ [mA]	$P_{OUT}$ [W]	$P_{LOSS}$ [W]	Efficiency [%]
90	0.05	14.459	0	0.000	0.051	0.00
90	0.06	14.352	1	0.014	0.048	23.15
90	0.08	14.279	2	0.029	0.046	38.08
90	0.12	14.164	5	0.071	0.052	57.58
90	0.16	14.132	7	0.099	0.058	63.01
90	0.21	14.106	10	0.141	0.068	67.49
90	0.29	14.077	15	0.211	0.083	71.82
90	0.38	14.059	20	0.281	0.096	74.58
90	0.53	13.968	30	0.419	0.115	78.47
90	0.85	13.883	50	0.694	0.153	81.95
90	1.16	13.833	70	0.968	0.194	83.33
90	1.63	13.784	100	1.378	0.256	84.36
90	2.89	13.740	179	2.459	0.429	85.16
90	3.22	13.736	200	2.747	0.474	85.29
90	4.81	13.717	300	4.115	0.693	85.59
90	5.73	13.710	358	4.908	0.821	85.67
90	7.98	13.697	500	6.849	1.132	85.82
90	8.55	13.696	536	7.341	1.210	85.85
90	11.45	13.685	715	9.785	1.664	85.46
90	12.85	13.681	800	10.945	1.909	85.15
90	16.17	13.665	1000	13.665	2.509	84.49
90	19.57	13.651	1200	16.381	3.184	83.73
90	20.26	13.625	1240	16.895	3.361	83.41
90	0.07	0.000	1250	0.000	0.070	0.00

Table 5. Load Regulation:  $V_{IN}=100$  Vac

$V_{IN}$ [Vac]	$P_{IN}$ [W]	$V_{OUT}$ [V]	$I_{OUT}$ [mA]	$P_{OUT}$ [W]	$P_{LOSS}$ [W]	Efficiency [%]
100	0.05	14.537	0	0.000	0.054	0.00
100	0.07	14.406	1	0.014	0.052	21.83
100	0.08	14.317	2	0.029	0.050	36.25
100	0.13	14.181	5	0.071	0.055	56.27
100	0.16	14.142	7	0.099	0.061	61.87
100	0.21	14.114	10	0.141	0.072	66.26
100	0.30	14.085	15	0.211	0.087	70.90
100	0.38	14.064	20	0.281	0.101	73.63
100	0.54	13.982	30	0.419	0.122	77.53
100	0.85	13.888	50	0.694	0.160	81.31
100	1.17	13.837	70	0.969	0.199	82.93
100	1.64	13.787	100	1.379	0.261	84.07
100	2.89	13.738	179	2.459	0.434	85.00
100	3.23	13.733	200	2.747	0.478	85.17
100	4.81	13.713	300	4.114	0.696	85.53
100	5.73	13.707	358	4.907	0.823	85.64
100	7.98	13.694	500	6.847	1.129	85.85
100	8.55	13.693	536	7.339	1.206	85.89
100	11.45	13.682	715	9.783	1.662	85.48
100	12.86	13.679	800	10.943	1.914	85.11
100	16.17	13.663	1000	13.663	2.511	84.48
100	19.55	13.649	1200	16.379	3.167	83.80
100	20.37	13.630	1250	17.038	3.330	83.65
100	0.08	0.000	1260	0.000	0.080	0.00

Table 6. Load Regulation:  $V_{IN}=115$  Vac

$V_{IN}$ [Vac]	$P_{IN}$ [W]	$V_{OUT}$ [V]	$I_{OUT}$ [mA]	$P_{OUT}$ [W]	$P_{LOSS}$ [W]	Efficiency [%]
115	0.06	14.611	0	0.000	0.062	0.00
115	0.07	14.458	1	0.014	0.059	19.81
115	0.09	14.354	2	0.029	0.057	33.38
115	0.13	14.197	5	0.071	0.062	53.37
115	0.17	14.151	7	0.099	0.068	59.32
115	0.22	14.114	10	0.141	0.077	64.74
115	0.30	14.088	15	0.211	0.093	69.51
115	0.39	14.067	20	0.281	0.110	71.95
115	0.55	14.005	30	0.420	0.133	75.98
115	0.87	13.896	50	0.695	0.171	80.23
115	1.18	13.842	70	0.969	0.211	82.11
115	1.65	13.789	100	1.379	0.273	83.47
115	2.91	13.737	179	2.459	0.446	84.64
115	3.24	13.732	200	2.746	0.492	84.82
115	4.82	13.712	300	4.114	0.710	85.27
115	5.74	13.705	358	4.906	0.836	85.45
115	7.99	13.691	500	6.846	1.142	85.71
115	8.56	13.690	536	7.338	1.217	85.77
115	11.46	13.681	715	9.782	1.678	85.36
115	12.88	13.677	800	10.942	1.942	84.92
115	16.22	13.662	1000	13.662	2.555	84.24
115	19.59	13.647	1200	16.376	3.211	83.61
115	20.65	13.641	1260	17.188	3.462	83.23
115	0.09	0.000	1270	0.000	0.090	0.00

Table 7. Load Regulation:  $V_{IN}=176$  Vac

$V_{IN}$ [Vac]	$P_{IN}$ [W]	$V_{OUT}$ [V]	$I_{OUT}$ [mA]	$P_{OUT}$ [W]	$P_{LOSS}$ [W]	Efficiency [%]
176	0.10	14.803	0	0.000	0.101	0.00
176	0.11	14.601	1	0.015	0.096	13.15
176	0.13	14.457	2	0.029	0.096	23.13
176	0.17	14.238	5	0.071	0.101	41.39
176	0.21	14.170	7	0.099	0.107	48.15
176	0.26	14.112	10	0.141	0.116	54.91
176	0.34	14.066	15	0.211	0.133	61.33
176	0.43	14.050	20	0.281	0.149	65.35
176	0.61	14.022	30	0.421	0.184	69.53
176	0.93	13.930	50	0.697	0.235	74.81
176	1.25	13.858	70	0.970	0.275	77.92
176	1.72	13.798	100	1.380	0.340	80.22
176	2.98	13.726	179	2.457	0.518	82.59
176	3.31	13.721	200	2.744	0.568	82.86
176	4.91	13.700	300	4.110	0.800	83.71
176	5.83	13.694	358	4.902	0.932	84.03
176	8.09	13.682	500	6.841	1.249	84.56
176	8.66	13.682	536	7.334	1.328	84.66
176	11.56	13.675	715	9.778	1.780	84.60
176	13.08	13.675	800	10.940	2.140	83.64
176	16.56	13.662	1000	13.662	2.901	82.49
176	20.06	13.648	1200	16.378	3.679	81.66
176	22.50	13.609	1330	18.100	4.398	80.45
176	0.17	0.000	1340	0.000	0.172	0.00

Performance Data -Continued

Table 8. Load Regulation : V<sub>IN</sub>=230 Vac

V <sub>IN</sub> [Vac]	P <sub>IN</sub> [W]	V <sub>OUT</sub> [V]	I <sub>OUT</sub> [mA]	P <sub>OUT</sub> [W]	P <sub>LOSS</sub> [W]	Efficiency [%]
230	0.15	15.041	0	0.000	0.148	0.00
230	0.16	14.764	1	0.015	0.143	9.34
230	0.17	14.577	2	0.029	0.143	16.95
230	0.22	14.292	5	0.071	0.148	32.63
230	0.25	14.204	7	0.099	0.155	39.14
230	0.30	14.130	10	0.141	0.163	46.48
230	0.39	14.069	15	0.211	0.180	53.97
230	0.48	14.038	20	0.281	0.202	58.13
230	0.66	14.015	30	0.420	0.237	64.00
230	1.01	13.985	50	0.699	0.307	69.51
230	1.32	13.884	70	0.972	0.351	73.46
230	1.80	13.811	100	1.381	0.417	76.81
230	3.05	13.720	179	2.456	0.596	80.47
230	3.39	13.714	200	2.743	0.648	80.88
230	5.00	13.693	300	4.108	0.896	82.09
230	5.94	13.687	358	4.900	1.038	82.52
230	8.21	13.673	500	6.837	1.374	83.27
230	8.78	13.674	536	7.329	1.451	83.48
230	11.63	13.665	715	9.770	1.860	84.01
230	13.23	13.663	800	10.930	2.300	82.62
230	16.83	13.646	1000	13.646	3.184	81.08
230	20.47	13.638	1200	16.366	4.104	79.95
230	24.02	13.583	1390	18.880	5.140	78.60
230	0.25	0.000	1400	0.000	0.250	0.00

Table 9. Load Regulation: V<sub>IN</sub>=264 Vac

V <sub>IN</sub> [Vac]	P <sub>IN</sub> [W]	V <sub>OUT</sub> [V]	I <sub>OUT</sub> [mA]	P <sub>OUT</sub> [W]	P <sub>LOSS</sub> [W]	Efficiency [%]
264	0.19	15.109	0	0.000	0.186	0.00
264	0.20	14.835	1	0.015	0.180	7.61
264	0.21	14.635	2	0.029	0.179	14.07
264	0.26	14.320	5	0.072	0.184	27.97
264	0.29	14.222	7	0.100	0.190	34.33
264	0.34	14.140	10	0.141	0.201	41.35
264	0.43	14.065	15	0.211	0.216	49.41
264	0.52	14.032	20	0.281	0.234	54.49
264	0.69	14.006	30	0.420	0.273	60.63
264	1.05	13.969	50	0.698	0.352	66.52
264	1.38	13.909	70	0.974	0.407	70.50
264	1.86	13.820	100	1.382	0.475	74.42
264	3.11	13.720	179	2.456	0.657	78.89
264	3.45	13.709	200	2.742	0.708	79.47
264	5.07	13.687	300	4.106	0.965	80.97
264	6.01	13.681	358	4.898	1.110	81.52
264	8.29	13.669	500	6.835	1.456	82.44
264	8.87	13.669	536	7.327	1.543	82.60
264	11.72	13.660	715	9.767	1.953	83.34
264	13.32	13.660	800	10.928	2.392	82.04
264	16.92	13.624	1000	13.624	3.296	80.52
264	20.57	13.607	1200	16.328	4.242	79.38
264	23.95	13.520	1400	18.928	5.022	79.03
264	0.30	0.000	1410	0.000	0.300	0.00

Performance Data -Continued

Line Regulation

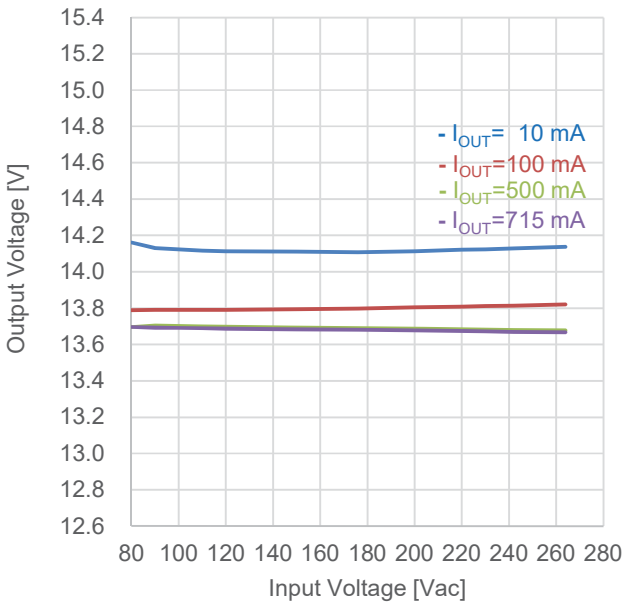

Figure 12. Line Regulation ( $I_{IN}$  vs.  $V_{OUT}$ )

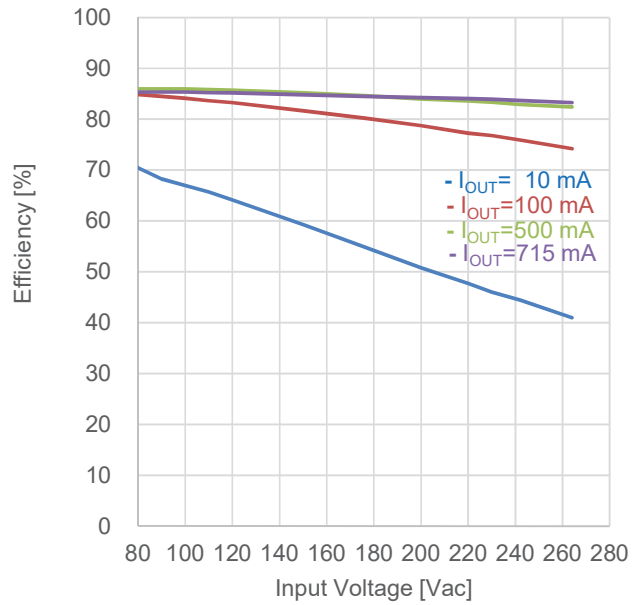

Figure 13. Line Regulation ( $I_{IN}$  vs. Efficiency)

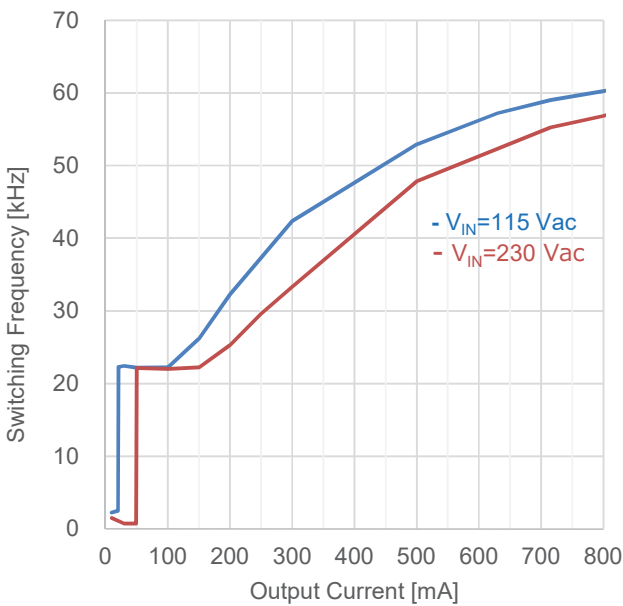

Figure 14. Switching Frequency ( $I_{OUT}$  vs.  $F_{SW}$ )

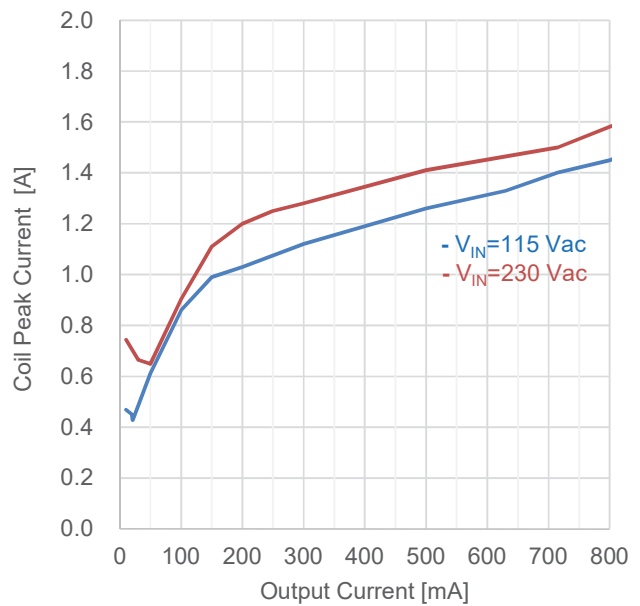

Figure 15. Coil Peak Current ( $I_{OUT}$  vs.  $I_{peak}$ )

Performance Data -Continued

Operation Waveform

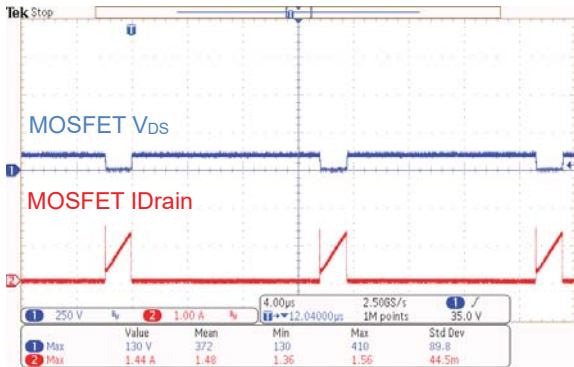

Figure 16. MOSFET  $V_{IN} = 90 \text{ Vac}$ ,  $I_{OUT} = 0.715 \text{ A}$

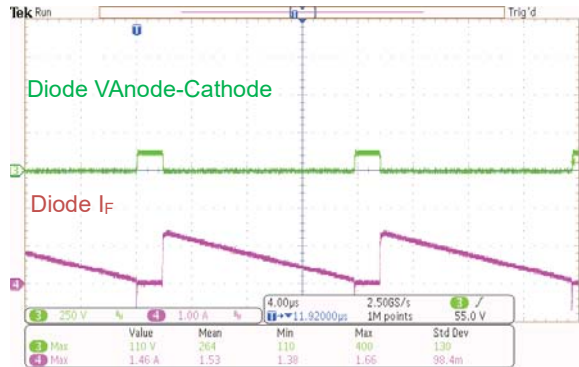

Figure 17. Diode  $V_{IN} = 90 \text{ Vac}$ ,  $I_{OUT} = 0.715 \text{ A}$

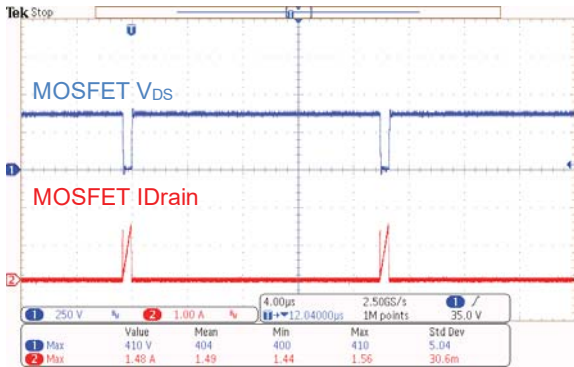

Figure 18. MOSFET  $V_{IN} = 264 \text{ Vac}$ ,  $I_{OUT} = 0.715 \text{ A}$

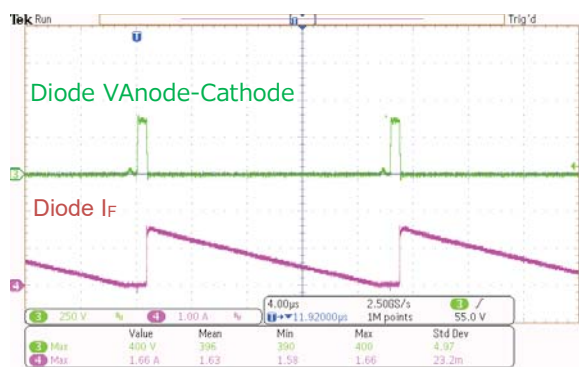

Figure 19. Diode  $V_{IN} = 264 \text{ Vac}$ ,  $I_{OUT} = 0.715 \text{ A}$

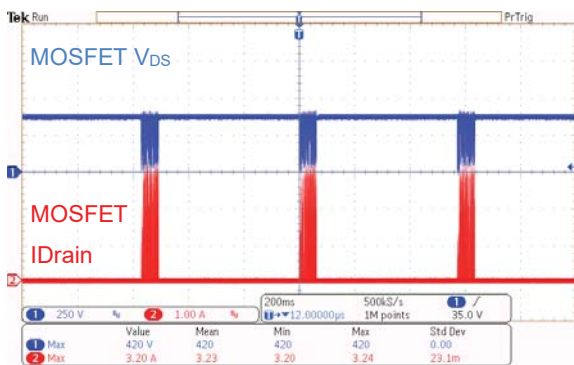

Figure 20. MOSFET  $V_{IN} = 264 \text{ Vac}$ , Output Short

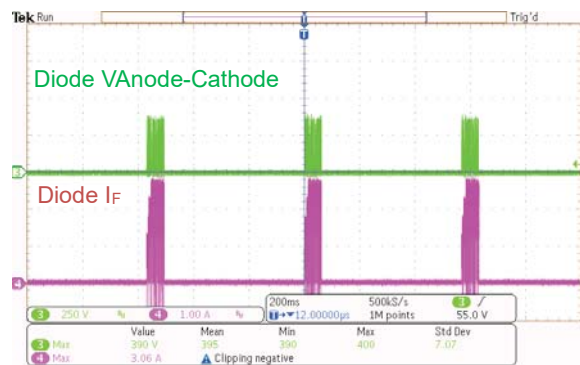

Figure 21. Diode  $V_{IN} = 264 \text{ Vac}$ , Output Short



Performance Data -Continued

Power ON

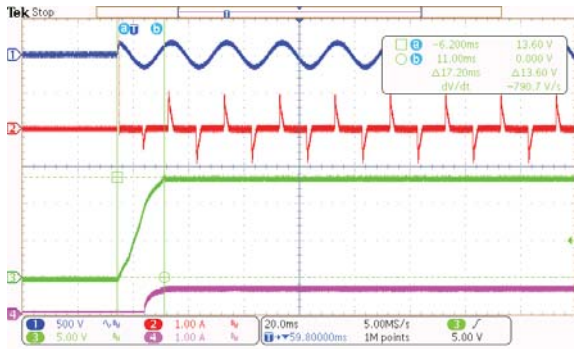

Figure 22.  $V_{IN} = 115 \text{ Vac}$ ,  $I_{OUT} = 0.715 \text{ A}$

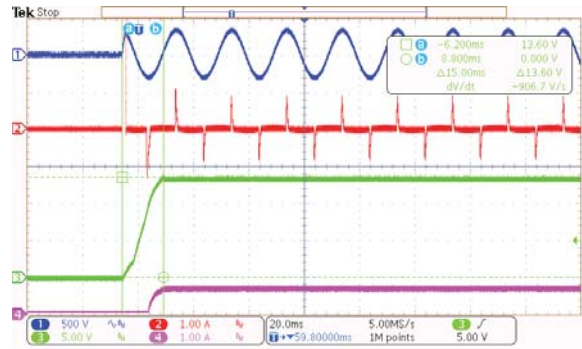

Figure 23.  $V_{IN} = 230 \text{ Vac}$ ,  $I_{OUT} = 0.715 \text{ A}$

Dynamic Response

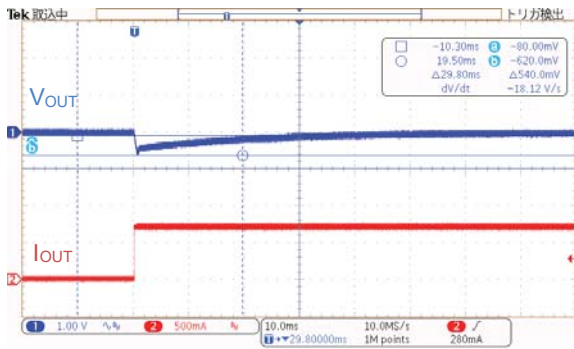

Figure 24.  $V_{IN} = 115 \text{ Vac}$ ,  $I_{OUT} = 10 \text{ mA} \rightarrow 0.715 \text{ A}$

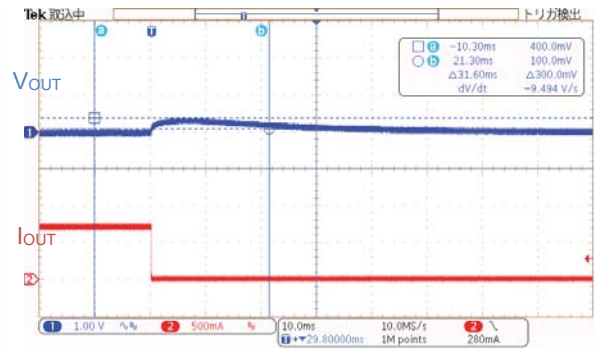

Figure 25.  $V_{IN} = 115 \text{ Vac}$ ,  $I_{OUT} = 0.715 \text{ A} \rightarrow 10 \text{ mA}$

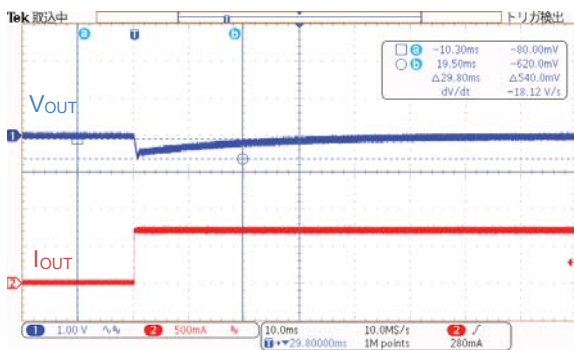

Figure 26.  $V_{IN} = 230 \text{ Vac}$ ,  $I_{OUT} = 10 \text{ mA} \rightarrow 0.715 \text{ A}$

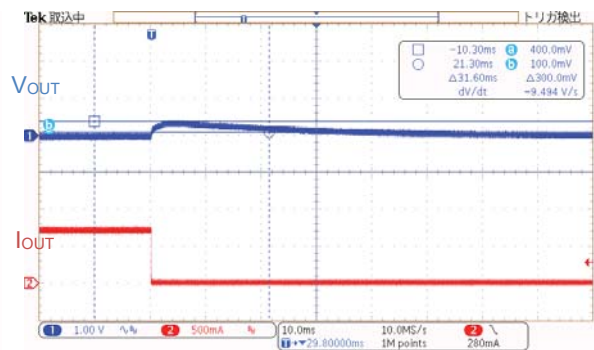

Figure 27.  $V_{IN} = 230 \text{ Vac}$ ,  $I_{OUT} = 0.715 \text{ A} \rightarrow 10 \text{ mA}$

Performance Data -Continued

Output Ripple Voltage

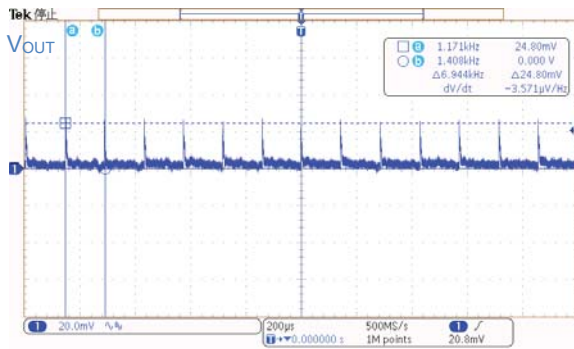

Figure 28.  $V_{IN} = 115 \text{ Vac}$ ,  $I_{OUT} = 10 \text{ mA}$

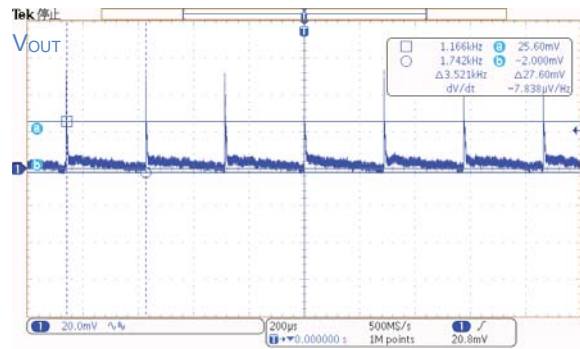

Figure 29.  $V_{IN} = 230 \text{ Vac}$ ,  $I_{OUT} = 10 \text{ mA}$

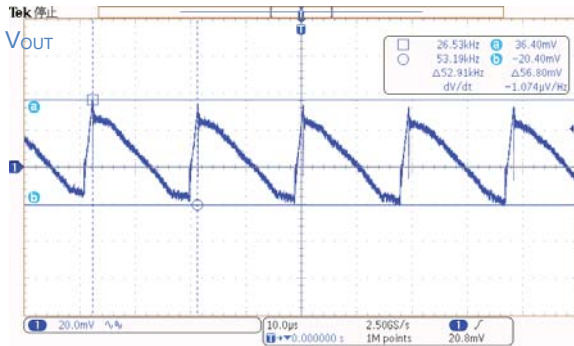

Figure 30.  $V_{IN} = 115 \text{ Vac}$ ,  $I_{OUT} = 0.5 \text{ A}$

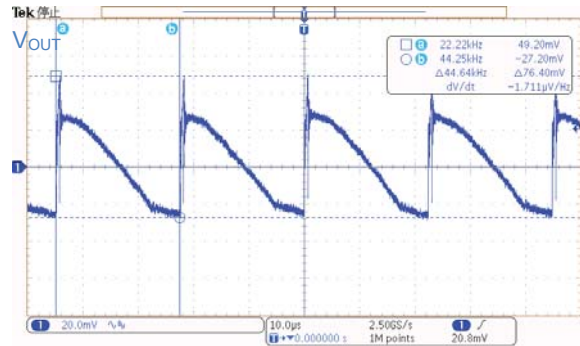

Figure 31.  $V_{IN} = 230 \text{ Vac}$ ,  $I_{OUT} = 0.5 \text{ A}$

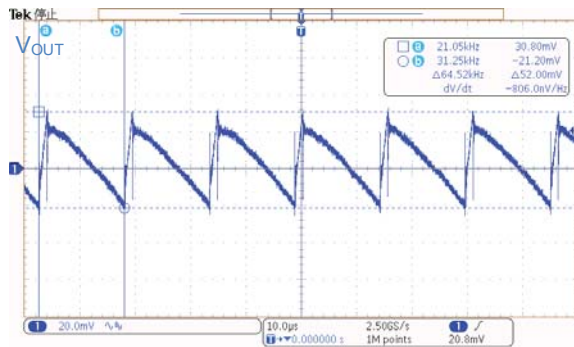

Figure 32.  $V_{IN} = 115 \text{ Vac}$ ,  $I_{OUT} = 0.715 \text{ A}$

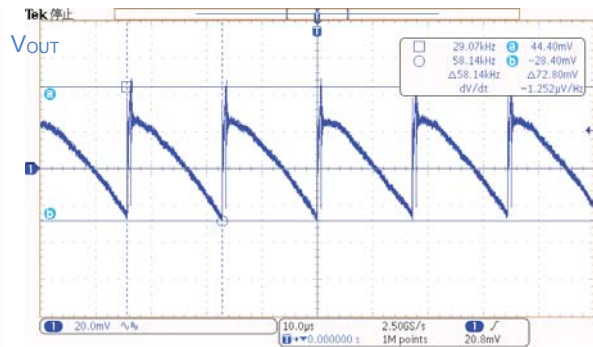

Figure 33.  $V_{IN} = 230 \text{ Vac}$ ,  $I_{OUT} = 0.715 \text{ A}$

Performance Data -Continued

Parts surface temperature

Table 10. Parts surface temperature

Ta = 25 °C, measured 30 minutes after startup

Part	Condition			
	V <sub>IN</sub> = 90 Vac, I <sub>OUT</sub> = 0.500 A	V <sub>IN</sub> = 90 Vac, I <sub>OUT</sub> = 0.715 A	V <sub>IN</sub> = 264 Vac, I <sub>OUT</sub> = 0.500 A	V <sub>IN</sub> = 264 Vac, I <sub>OUT</sub> = 0.715 A
IC1	50.4 °C	67.3 °C	51.8 °C	64.9 °C
D1	61.5 °C	76.9 °C	64.3 °C	77.5 °C
DB1	49.6 °C	54.8 °C	44.1 °C	46.0 °C
L1	49.8 °C	61.8 °C	47.6 °C	62.5 °C

EMI

•Conducted Emission: CISPR22 Pub 22 Class B

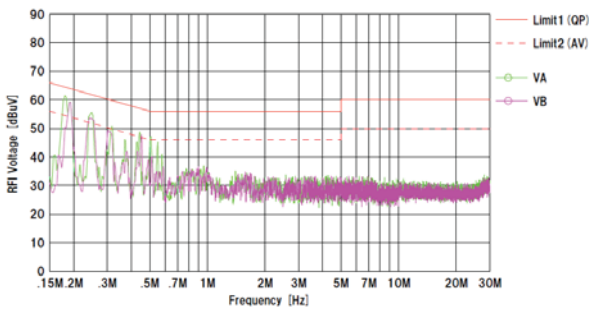

Figure 34. V<sub>IN</sub> = 110 Vac / 60 Hz, I<sub>OUT</sub> = 0.715 A  
QP margin = 13.5 dB, AV margin = 20.5 dB

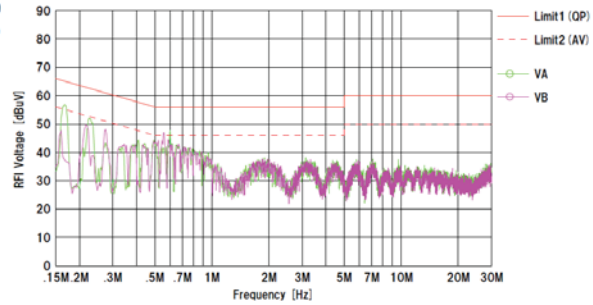

Figure 35. V<sub>IN</sub> = 230 Vac / 50 Hz, I<sub>OUT</sub> = 0.715 A  
QP margin = 18.3 dB, AV margin = 23.9 dB

•Radiated Emission: CISPR22 Pub 22 Class B

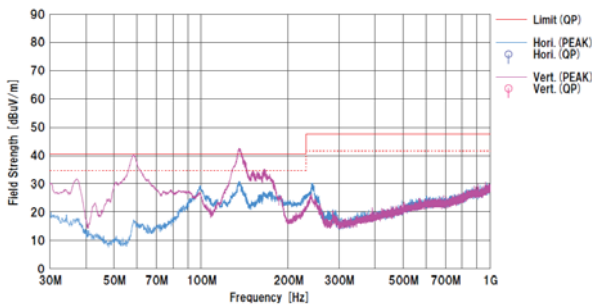

Figure 36. V<sub>IN</sub> = 110 Vac / 60 Hz, I<sub>OUT</sub> = 0.715 A  
QP margin = 6.6 dB

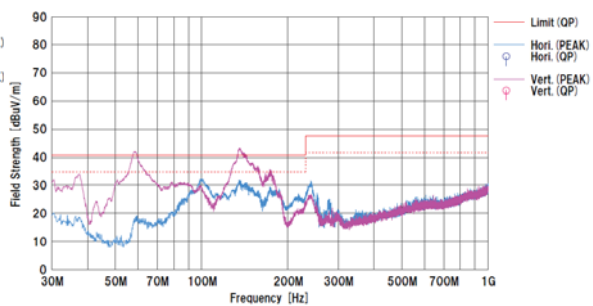

Figure 37. V<sub>IN</sub> = 230 Vac / 50 Hz, I<sub>OUT</sub> = 0.715 A  
QP margin = 6.0 dB

Schematics

V<sub>IN</sub> = 90~264 Vac, V<sub>OUT</sub> = 14 V

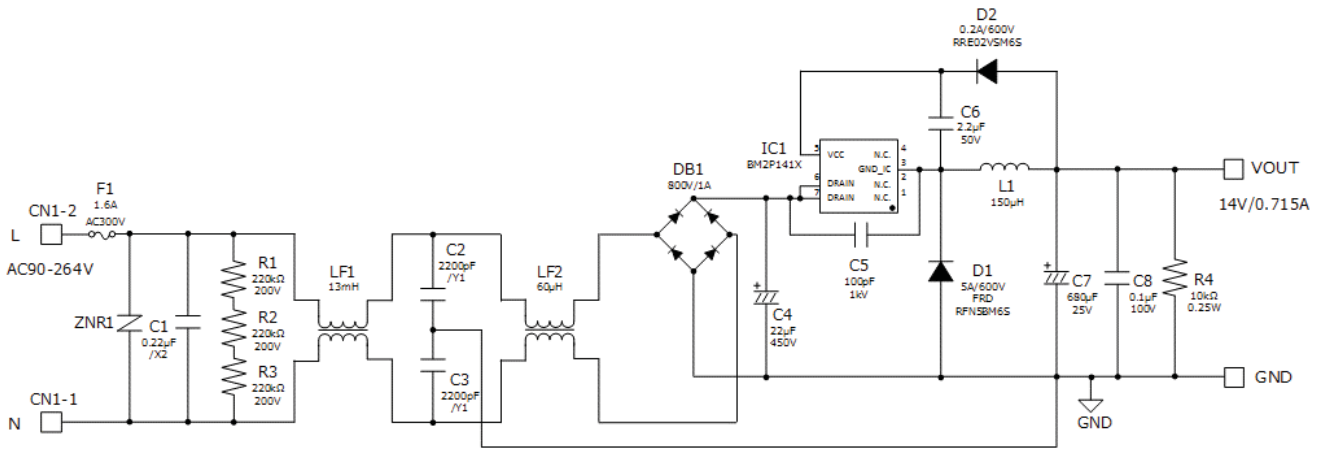

Figure 38. BM2P141X-EVK-001 Schematics

Bill of Materials

Table 11. BoM of BM2P141X-EVK-001

Part Reference	Qty.	Type	Value	Description	Part Number	Manufacture	Configuration mm (inch)
C1	1	X2 Capacitor	0.22μF	275Vac, ±20%	890324023028CS	Wurth	-
C2,C3	2	Y1 Capacitor	2200pF	Y1 capacitor	DE1E3KX222MB4BP01F	Murata	-
C4	1	Electrolytic	22μF	450V, ±20%	450BXW22MEFR12.5X20	Rubycon	12.5mmΦX20mm
C5	1	Ceramic	100pF	1kV, C0G, ±10%	GRM31A5C3A101J	Murata	3216 (1206)
C6	1	Ceramic	2.2μF	50V, X7R, ±10%	UMK316B7225KL-T	Taiyo Yuden	3216 (1206)
C7	1	Electrolytic	680uF	25V, ±20%	UPA1E681MPD	Nichicon	10mmΦX16mm
C8	1	Ceramic	0.1μF	100V, X7R, ±10%	HMK107B7104MA-T	Taiyo Yuden	1608 (0603)
CN1	1	Connector	2pin	5mm pitch	B2P-NV	JST	-
D1	1	FRD	5A	600V	RFN5BM6S	ROHM	TO-252
D2	1	REC Di	0.2A	600V	RRE02VSM6S	ROHM	TUMD2SM
DB1	1	Bridge	1A	800V	D1UBA80	Shindengen	SOP-4
F1	1	Fuse	1.6A	1.6A 300V	36911600000	Littelfuse	-
IC1	1	AC/DC Converter	-	650V	BM2P141X-Z	ROHM	DIP7
JP1	1	Jumper	-	Jumper Wire	-	-	Φ0.5mm
L1	1	Coil	150μH	1.9A	XF1501Y-151	Alpha Trans	-
LF1	1	Line Filter	13mH	1A	XF1482Y	Alpha Trans	-
LF2	1	Line Filter	60μH	1A	LF1246Y	Alpha Trans	-
PCB	1	FR4	-	-	-	-	-
R1,R2,R3	3	Resistor	220kΩ	0.25W, ±5%	MCR18EZPJ224	ROHM	3216 (1206)
R4	1	Resistor	10kΩ	0.25W, ±5%	MCR18EZPJ103	ROHM	3216 (1206)
ZNR1	1	Varistor	-	300Vac, 423Vmin, 400A	V470ZA05P	Littelfuse	5mmΦ Disc

PCB

Size : 91 mm x 30 mm

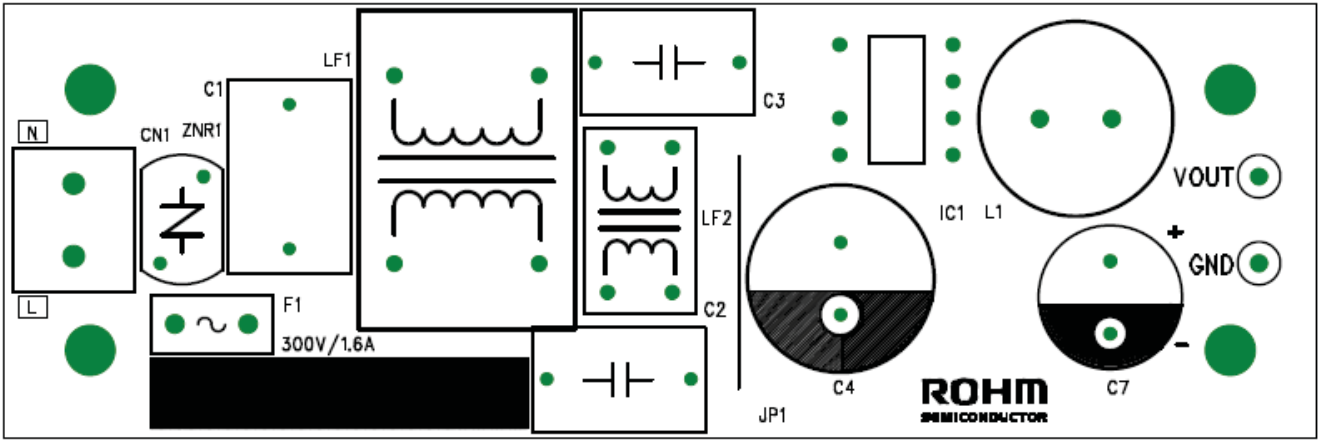

Figure 39. Top Silkscreen (Top view)

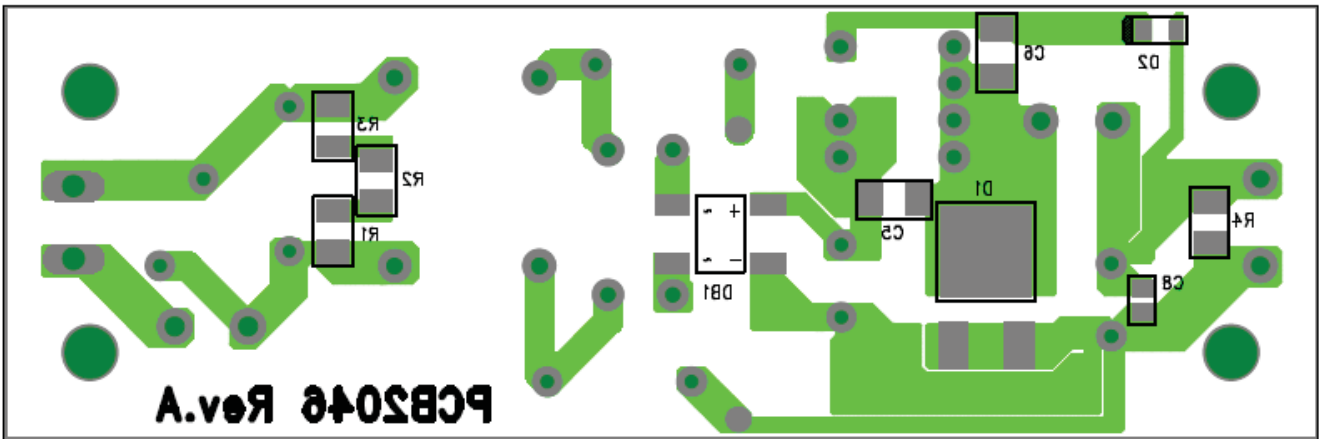

Figure 40. Bottom Layout (Top view)

## Notes

- 1) The information contained herein is subject to change without notice.
- 2) Before you use our Products, please contact our sales representative and verify the latest specifications :
- 3) Although ROHM is continuously working to improve product reliability and quality, semiconductors can break down and malfunction due to various factors.  
Therefore, in order to prevent personal injury or fire arising from failure, please take safety measures such as complying with the derating characteristics, implementing redundant and fire prevention designs, and utilizing backups and fail-safe procedures. ROHM shall have no responsibility for any damages arising out of the use of our Products beyond the rating specified by ROHM.
- 4) Examples of application circuits, circuit constants and any other information contained herein are provided only to illustrate the standard usage and operations of the Products. The peripheral conditions must be taken into account when designing circuits for mass production.
- 5) The technical information specified herein is intended only to show the typical functions of and examples of application circuits for the Products. ROHM does not grant you, explicitly or implicitly, any license to use or exercise intellectual property or other rights held by ROHM or any other parties. ROHM shall have no responsibility whatsoever for any dispute arising out of the use of such technical information.
- 6) The Products specified in this document are not designed to be radiation tolerant.
- 7) For use of our Products in applications requiring a high degree of reliability (as exemplified below), please contact and consult with a ROHM representative : transportation equipment (i.e. cars, ships, trains), primary communication equipment, traffic lights, fire/crime prevention, safety equipment, medical systems, servers, solar cells, and power transmission systems.
- 8) Do not use our Products in applications requiring extremely high reliability, such as aerospace equipment, nuclear power control systems, and submarine repeaters.
- 9) ROHM shall have no responsibility for any damages or injury arising from non-compliance with the recommended usage conditions and specifications contained herein.
- 10) ROHM has used reasonable care to ensure the accuracy of the information contained in this document. However, ROHM does not warrants that such information is error-free, and ROHM shall have no responsibility for any damages arising from any inaccuracy or misprint of such information.
- 11) Please use the Products in accordance with any applicable environmental laws and regulations, such as the RoHS Directive. For more details, including RoHS compatibility, please contact a ROHM sales office. ROHM shall have no responsibility for any damages or losses resulting non-compliance with any applicable laws or regulations.
- 12) When providing our Products and technologies contained in this document to other countries, you must abide by the procedures and provisions stipulated in all applicable export laws and regulations, including without limitation the US Export Administration Regulations and the Foreign Exchange and Foreign Trade Act.
- 13) This document, in part or in whole, may not be reprinted or reproduced without prior consent of ROHM.



Thank you for your accessing to ROHM product informations.  
More detail product informations and catalogs are available, please contact us.

**ROHM Customer Support System**

<http://www.rohm.com/contact/>