

Zener diode

TDZ9.1

●Applications

Constant voltage control

●Features

- 1) Small mold type. (TUMD2)
- 2) High reliability.
- 3) Can be mounted automatically, using chip mounter.

●Construction

Silicon epitaxial planar

●Dimensions (Unit : mm)

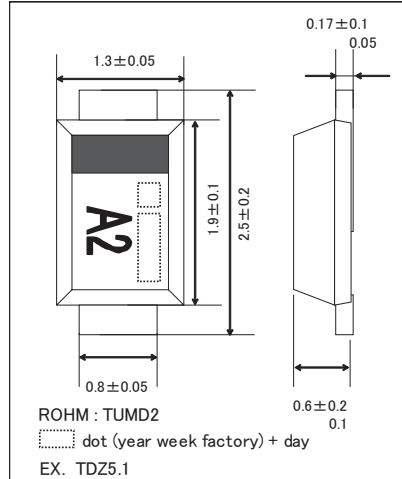

●Land size figure (Unit : mm)

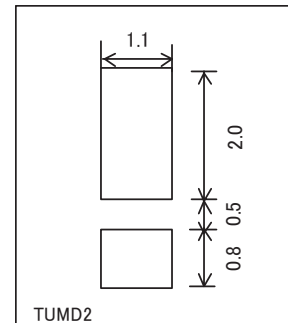

●Structure

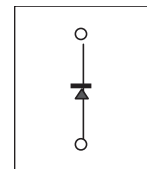

●Taping specifications (Unit : mm)

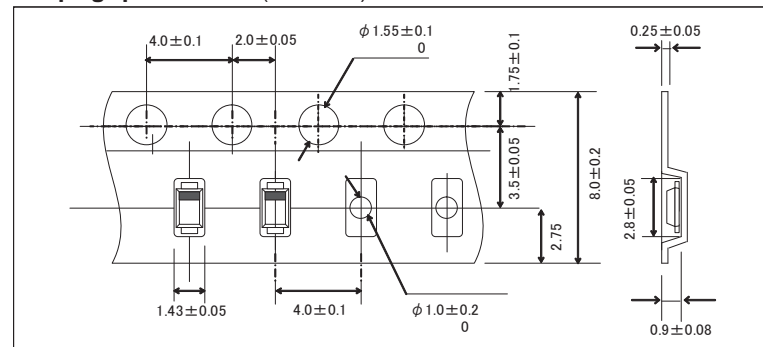

●Absolute maximum ratings (Ta=25°C)

Parameter	Symbol	Limits	Unit
Power dissipation	P	500	mW
Junction temperature	Tj	150	°C
Storage temperature	Tstg	-55 to 150	°C
Operating resistance	Topr	-55 to 150	°C

Diodes

●Electrical characteristics (Ta=25°C)

TYP.	Symbol				
	Zener voltage : Vz(V)			Reverse current : IR(μA)	
	MIN.	MAX.	Iz(mA)	MAX.	VR(V)
TDZ 5.1	4.60	5.60	10	10	1.5
TDZ 5.6	5.10	6.10	10	10	2.5
TDZ 6.2	5.60	6.80	10	10	3.0
TDZ 6.8	6.20	7.40	10	10	3.5
TDZ 7.5	6.80	8.30	10	10	4.5
TDZ 8.2	7.40	9.00	10	10	4.9
TDZ 9.1	8.20	10.00	10	10	5.5
TDZ 10	9.00	11.00	10	10	6.0
TDZ 11	9.90	12.10	10	10	7.0
TDZ 12	10.80	13.20	10	10	8.0
TDZ 13	11.70	14.30	10	10	9.0
TDZ 15	13.50	16.50	10	10	10.0
TDZ 16	14.40	17.60	10	10	11.0
TDZ 18	16.20	19.80	10	10	12.0
TDZ 20	18.00	22.00	10	10	14.0
TDZ 22	19.80	24.20	10	10	15.0
TDZ 24	21.60	26.40	10	10	16.0
TDZ 27	24.30	29.70	10	10	19.0
TDZ 30	27.00	33.00	10	10	21.0

(1)The zener voltage(Vz) is measured 40ms after power is supplied.

(2)The operating resistances(Zz,Zzk) are measured by superimposing a minute alternating current on the regulated current(Iz)

●Type No.

TYPE	TYPE NO.	TYPE	TYPE NO.
TDZ 5.1	A2	TDZ 13	35
TDZ 5.6	C2	TDZ 15	45
TDZ 6.2	E2	TDZ 16	55
TDZ 6.8	F2	TDZ 18	65
TDZ 7.5	H2	TDZ 20	75
TDZ 8.2	J2	TDZ 22	85
TDZ 9.1	L2	TDZ 24	95
TDZ 10	05	TDZ 27	A5
TDZ 11	15	TDZ 30	C5
TDZ 12	25		

Diodes

●Electrical characteristic curves (Ta=25°C)

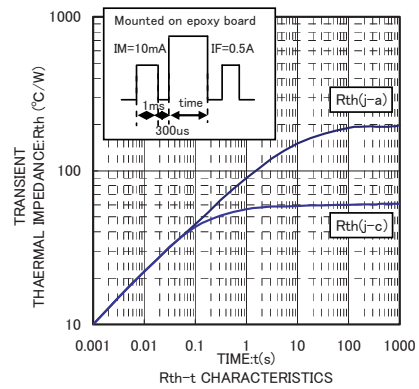
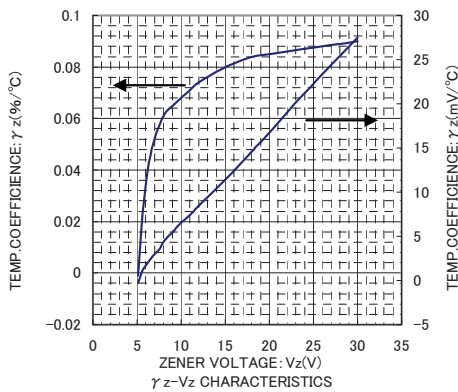
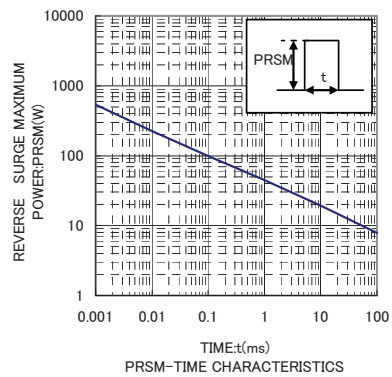
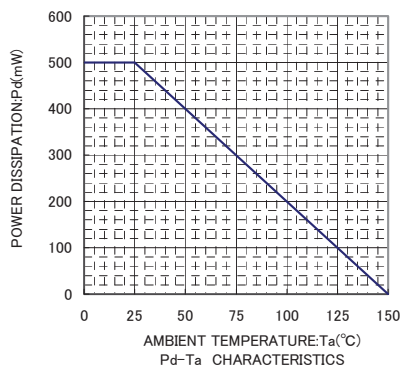
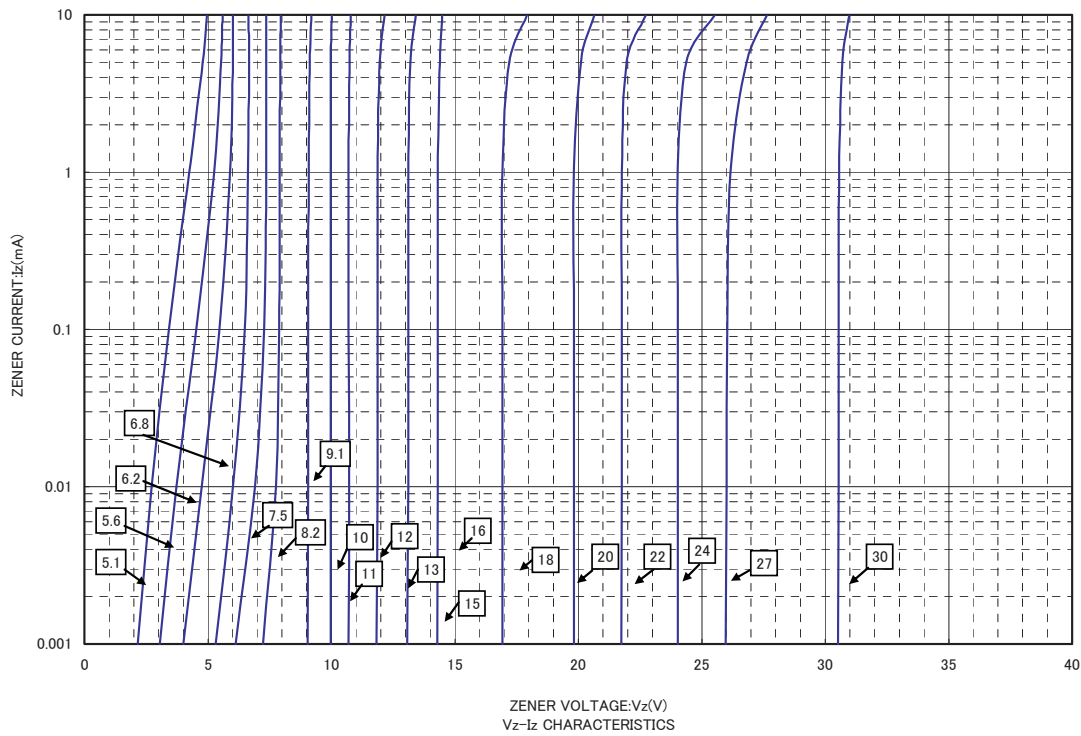

Diodes

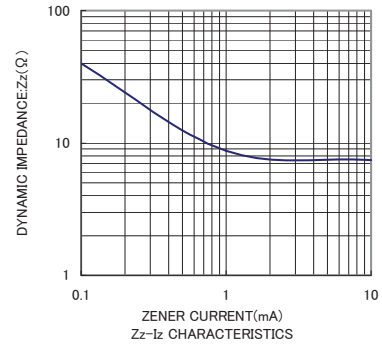
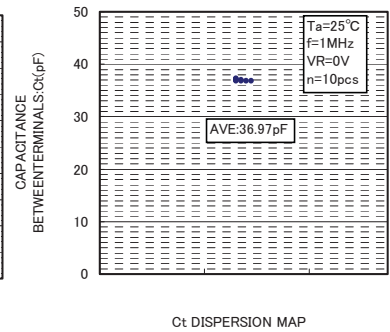
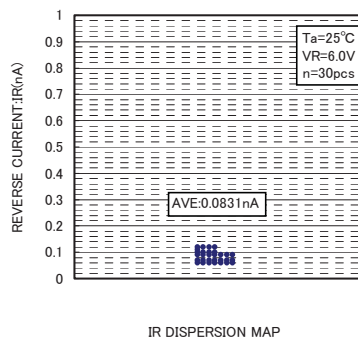
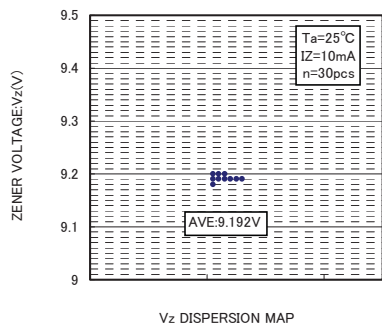
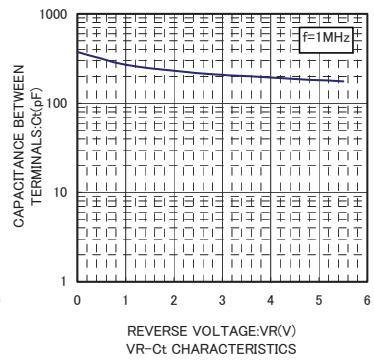
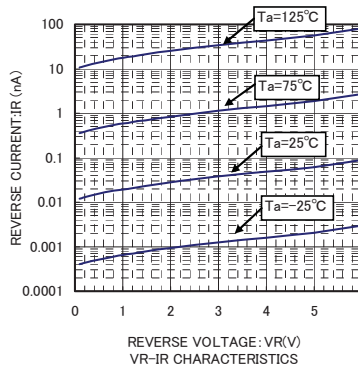
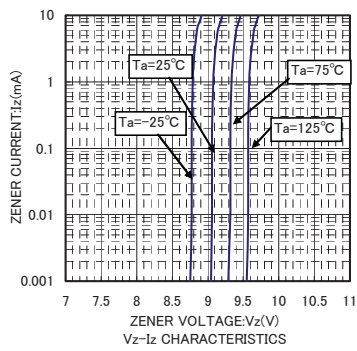

Notes

- No technical content pages of this document may be reproduced in any form or transmitted by any means without prior permission of ROHM CO.,LTD.
- The contents described herein are subject to change without notice. The specifications for the product described in this document are for reference only. Upon actual use, therefore, please request that specifications to be separately delivered.
- Application circuit diagrams and circuit constants contained herein are shown as examples of standard use and operation. Please pay careful attention to the peripheral conditions when designing circuits and deciding upon circuit constants in the set.
- Any data, including, but not limited to application circuit diagrams information, described herein are intended only as illustrations of such devices and not as the specifications for such devices. ROHM CO.,LTD. disclaims any warranty that any use of such devices shall be free from infringement of any third party's intellectual property rights or other proprietary rights, and further, assumes no liability of whatsoever nature in the event of any such infringement, or arising from or connected with or related to the use of such devices.
- Upon the sale of any such devices, other than for buyer's right to use such devices itself, resell or otherwise dispose of the same, no express or implied right or license to practice or commercially exploit any intellectual property rights or other proprietary rights owned or controlled by
- ROHM CO., LTD. is granted to any such buyer.
- Products listed in this document are no antiradiation design.

The products listed in this document are designed to be used with ordinary electronic equipment or devices (such as audio visual equipment, office-automation equipment, communications devices, electrical appliances and electronic toys).

Should you intend to use these products with equipment or devices which require an extremely high level of reliability and the malfunction of which would directly endanger human life (such as medical instruments, transportation equipment, aerospace machinery, nuclear-reactor controllers, fuel controllers and other safety devices), please be sure to consult with our sales representative in advance.

It is our top priority to supply products with the utmost quality and reliability. However, there is always a chance of failure due to unexpected factors. Therefore, please take into account the derating characteristics and allow for sufficient safety features, such as extra margin, anti-flammability, and fail-safe measures when designing in order to prevent possible accidents that may result in bodily harm or fire caused by component failure. ROHM cannot be held responsible for any damages arising from the use of the products under conditions out of the range of the specifications or due to non-compliance with the NOTES specified in this catalog.

Thank you for your accessing to ROHM product informations.

More detail product informations and catalogs are available, please contact your nearest sales office.

ROHM Customer Support System

THE AMERICAS / EUROPE / ASIA / JAPAN

www.rohm.com

Contact us : webmaster@rohm.co.jp