

Reversible Motor Drivers for Brush Motors

2.0A or More Reversible Motor Drivers (Single Motor)



BA6219BFP-Y,BA6222

No.11008EBT03

●Description

These motor drivers are full bridge drivers for brush motor applications, supporting output currents of up to 2A. The output modes are available in four modes, normal, reverse, stop (idling), and braking in accordance with input logic (2 inputs). The output voltage can be optionally set by reference voltage setting pin.

●Features

- 1) Large output current ($I_{OMAX}=2.2A$)
- 2) Built-in thermal shutdown circuit
- 3) Output voltage can be optionally set by reference voltage setting pin
- 4) High output voltage can be set by low voltage input because of it has 11.4dB gain (BA6222)
- 5) Low standby current

●Applications

Audio-visual equipment; PC peripherals; Car audios; Car navigation systems; OA equipments

●Absolute maximum ratings (Ta=25°C, All voltages are with respect to ground)

Parameter	Symbol	Ratings		Unit
		BA6219BFP-Y	BA6222	
Supply voltage	VCC1, VCC2	24		V
Output current	I_{OMAX}	2.2* ¹		A
All other input pins	V_{IN}	-0.3 ~ VCC1	-0.3 ~ VCC1+0.3	V
Operating temperature	T_{OPR}	-25 ~ 75		°C
Storage temperature	T_{STG}	-55 ~ 150	-55 ~ 125	°C
Power dissipation	P_d	1.45* ²	2.00* ³	W
Junction temperature	T_{jmax}	150	125	°C

*1 Do not, exceed P_d or ASO (Pulse at 1/100 duty: 500 μ s).

*2 HSOP25 package. Mounted on a 70mm x 70mm x 1.6mm FR4 glass-epoxy board with less than 3% copper foil. Derated at 11.6mW/°C above 25°C.

*3 HSIP10 package. Derated at 20mW/°C above 25°C.

●Operating conditions (Ta=25°C)

Parameter	Symbol	Ratings	Unit
Supply voltage	VCC1, VCC2	8 ~ 18	V

● **Electrical characteristics** (BA6219BFP-Y, unless otherwise specified, Ta=25°C and VCC1=VCC2=12V)

Parameter	Symbol	Limits			Unit	Conditions
		Min.	Typ.	Max.		
Supply current 1	I _{CC1}	-	1.2	2.5	mA	Standby mode
Supply current 2	I _{CC2}	-	16	35	mA	FWD/REV mode
Supply current 3	I _{CC3}	-	25	60	mA	Brake mode
Input threshold voltage H	V _{IH}	3.0	-	VCC1	V	
Input threshold voltage L	V _{IL}	0	-	1.0	V	
VR bias current	I _{VREF}	0.6	1.2	2.4	mA	R _L =60Ω, VR=6.8V
CD1 current	I _{CD1}	0.7	1.5	3.0	mA	(IN1, IN2)=(H, L), CD1 -> GND
CD2 current	I _{CD2}	0.7	1.5	3.0	mA	(IN1, IN2)=(L, H), CD2 -> GND
Output leak current	I _{OL}	-	-	1	mA	(IN1, IN2)=(L, L), VCC2 current
Output voltage H	V _{OH}	6.5	-	-	V	R _L =60Ω, VR=6.8V
Output voltage L	V _{OL}		-	1.2	V	R _L =60Ω, VR=6.8V

● **Electrical characteristics** (BA6222, unless otherwise specified, Ta=25°C and VCC1=VCC2=12V)

Parameter	Symbol	Limits			Unit	Conditions
		Min.	Typ.	Max.		
Supply current 1	I _{CC1}	-	1.2	2.5	mA	Standby mode, VR=0V
Supply current 2	I _{CC2}	-	16	35	mA	FWD/REV mode, VR=0V
Supply current 3	I _{CC3}	-	25	60	mA	Brake mode, VR=0V
Input threshold voltage H	V _{IH}	3.0	-	VCC1	V	
Input threshold voltage L	V _{IL}	0	-	1.0	V	
VR bias current	I _{VREF}	-	1.2	5.0	μA	VR=1.0V
VR-OUT trans. gain	G _V	10.35	11.35	12.35	dB	(IN1, IN2)=(H, L) or (L, H), I _{OUT} =0.1A* ¹
CD1 current	I _{CD1}	0.7	1.5	3.0	mA	(IN1, IN2)=(H, L), CD1 -> GND
CD2 current	I _{CD2}	0.7	1.5	3.0	mA	(IN1, IN2)=(L, H), CD2 -> GND
Output leak current	I _{OL}	-	-	1	mA	(IN1, IN2)=(L, L), VCC2 current
Output voltage H	V _{OH}	9.5	-	-	V	I _{OUT} =0.1A, VR=5V
Output voltage L	V _{OL}		-	0.5	V	I _{OUT} =0.1A, VR=5V

*1 Vout1 = V_{OH}-V_{OL} @VR=1V
 Vout2 = V_{OH}-V_{OL} @VR=2V
 These voltages are stabilized value without any heat radiation board.

$$GV = 20 \log \frac{V_{out2} - V_{out1}}{2V - 1V}$$

●Electrical characteristic curves (Reference data)

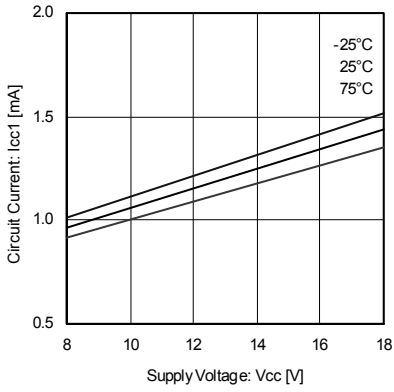

Fig.1 Supply current 1 (standby) (BA6219BFP-Y)

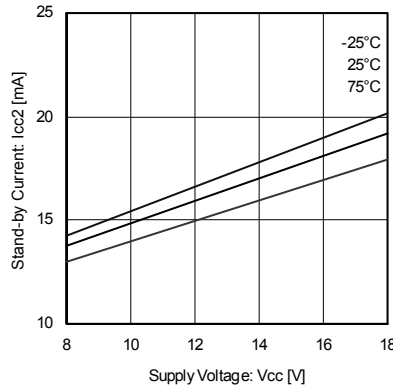

Fig.2 Supply current 2 (reverse) (BA6219BFP-Y)

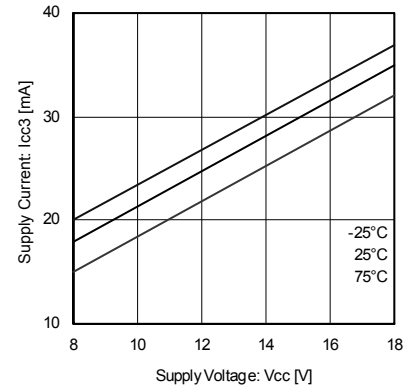

Fig.3 Supply current 3 (brake) (BA6219BFP-Y)

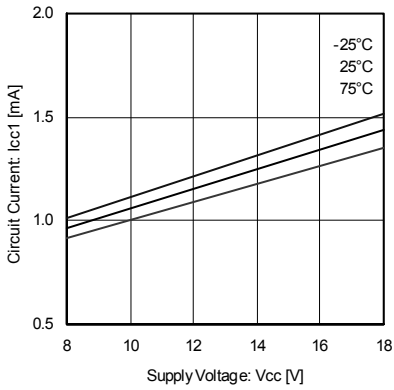

Fig.4 Supply current 1 (standby) (BA6222)

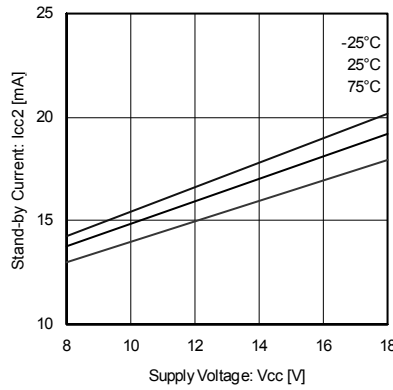

Fig.5 Supply current 2 (reverse) (BA6222)

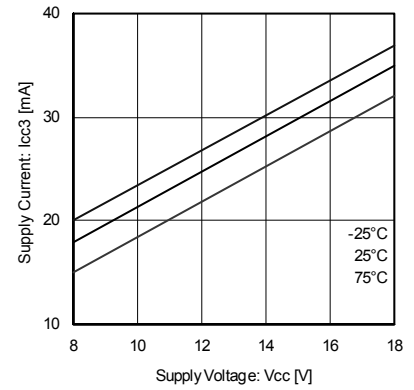

Fig.6 Supply current 3 (brake) (BA6222)

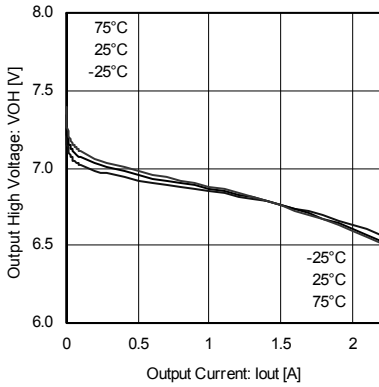

Fig.7 Output high voltage (BA6219BFP-Y)

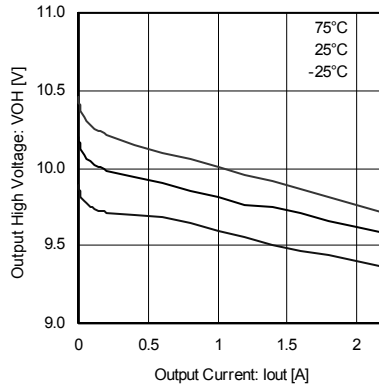

Fig.8 Output high voltage (BA6222)

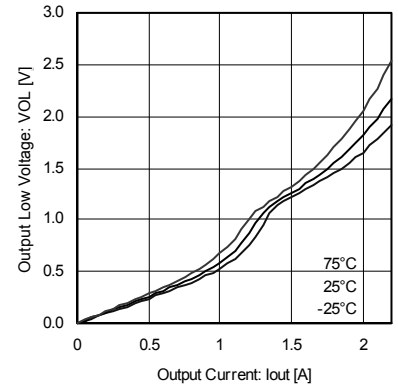

Fig.9 Output low voltage (BA6219BFP-Y)

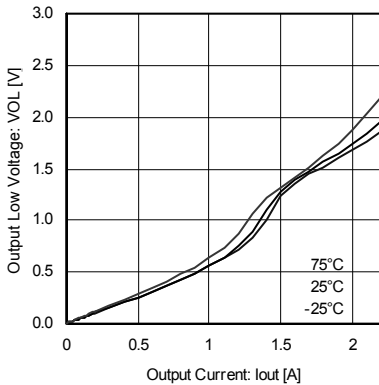

Fig.10 Output low voltage (BA6222)

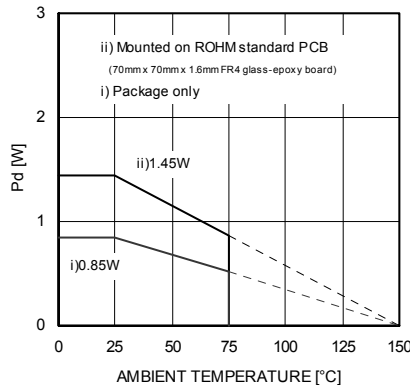

Fig.11 Thermal derating curve (HSOP25)

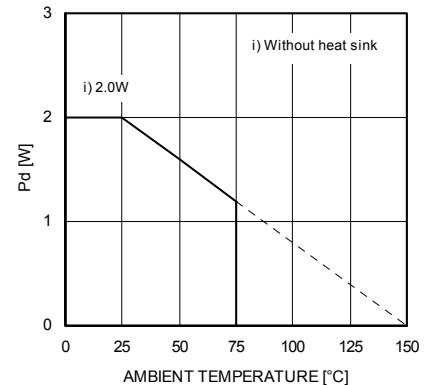

Fig.12 Thermal derating curve (HSIP10)

●Block diagram and pin configuration

BA6219BFP-Y

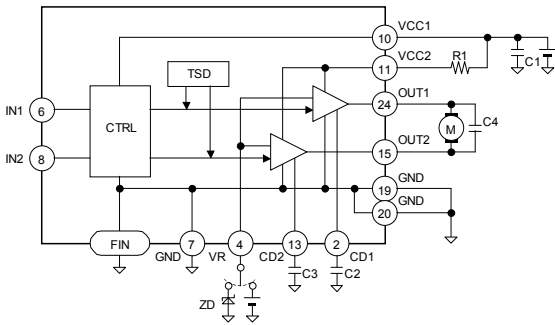

Fig.13 BA6219BFP-Y

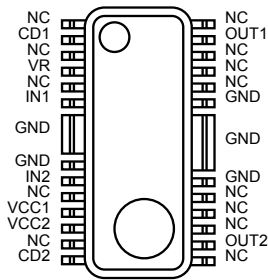

Fig.14 HSOP25

Table 1 BA6219BFP-Y

Pin	Name	Function
2	CD1	Cross conduction control pin
4	VR	Reference voltage setting pin
6	IN1	Control input (forward)
7	GND	GND
8	IN2	Control input (reverse)
10	VCC1	Power supply (small signal)
11	VCC2	Power supply (driver stage)
13	CD2	Cross conduction control pin
15	OUT2	Driver output
19	GND	GND
20	GND	GND
24	OUT1	Driver output
FIN	GND	GND

Note: All pins not described above are NC pins.

BA6222

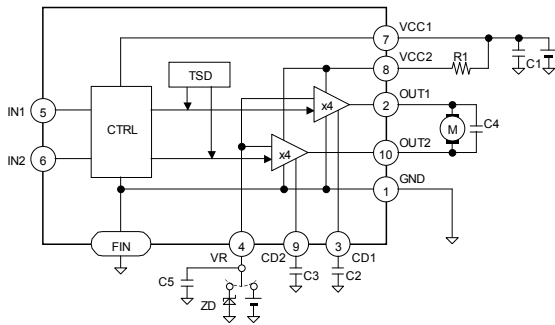

Fig.15 BA6222

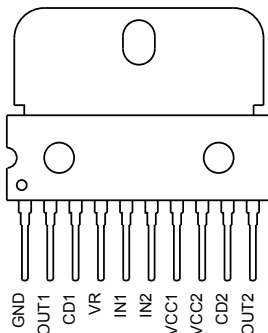

Fig.16 HSIP10

Table 2 BA6222

Pin	Name	Function
1	GND	GND
2	OUT1	Driver output
3	CD1	Cross conduction control pin
4	VR	Reference voltage setting pin
5	IN1	Control input (forward)
6	IN2	Control input (reverse)
7	VCC1	Power supply (small signal)
8	VCC2	Power supply (driver stage)
9	CD2	Cross conduction control pin
10	OUT2	Driver output
FIN	GND	GND

●External application components

- 1) Resistor for the current limitation, R1
This is a current limiting resistor for collector loss reduction and at the time of short-circuited output. It depends on the power supply voltage used, etc., but choose resistance of about 5 to 10Ω. In addition, set resistance with utmost care to voltage drop caused by inrush current that flows when the motor is started.
- 2) Zener diode for the output high voltage setting, ZD
This is the zener diode used when output high voltage (VR pin voltage) is set.
BA6219BFP-Y: Output high voltage ≈ zener voltage
BA6222: Output high voltage ≈ fourfold zener voltage
- 3) Stabilization capacitor for the power supply line, C1
Please connect the capacitor of 1μF to 100μF for the stabilization of the power supply line, and confirm the motor operation.
- 4) Capacitors for the cross conduction control of output transistors, C2 and C3
Simultaneous ON is prevented by delaying base potential buildup of transistors which enter output high state. Set the capacitors from 0.01μF to 1μF and make sure inrush current caused by simultaneous output ON does not flow when output mode is switched.
- 5) Phase compensating capacitor, C4
Noise is generated in output pins or oscillation results in accord with the set mounting state such as power supply circuit, motor characteristics, PCB pattern artwork, etc. As noise oscillation measures, connect 0.01μF to 0.1μF capacitors.
- 6) Phase compensating capacitor, C5 (BA6222 only)
The gain about fourfold VR pin voltage in output high voltage is set, and the output oscillates easily. Please connect the capacitor of 3300pF to 0.1μF as an oscillation prevention measures when the oscillation is seen in the output voltage.

●Functional descriptions

- 1) Operation modes

Table 3 Logic table

IN1	IN2	OUT1	OUT2	Operation
L	L	OPEN*	OPEN*	Stop (idling)
H	L	H	L	Forward (OUT1 > OUT2)
L	H	L	H	Reverse (OUT1 < OUT2)
H	H	L	L	Brake (stop)

*OPEN is the off state of all output transistors.

Please note that this is the state of the connected diodes, which differs from that of the mechanical relay.

- a) Stand-by mode
In stand-by mode, all output power transistors are turned off, and the motor output goes to high impedance.
- b) Forward mode
This operating mode is defined as the forward rotation of the motor when the OUT1 pin is high and OUT2 pin is low. When the motor is connected between the OUT1 and OUT2 pins, the current flows from OUT1 to OUT2.
- c) Reverse mode
This operating mode is defined as the reverse rotation of the motor when the OUT1 pin is low and OUT2 pin is high. When the motor is connected between the OUT1 and OUT2 pins, the current flows from OUT2 to OUT1.
- d) Brake mode
This operating mode is used to quickly stop the motor (short circuit brake).

2) Output high voltage setting

This function optionally sets output voltage by the output high voltage setting pin and controls the motor rotating speed. However, when the output high voltage is set to a low level, consumption at IC increases. Carry out thermal design with sufficient margin incorporated with the power dissipation (Pd) under the actual application condition taken into account.

a) BA6219BFP-Y

The circuit diagram associated with the output high voltage setting VR pin is as per shown on the right. The maximum output voltage V_{OMAX} is expressed by:

$$V_{OMAX} = VCC1 - (V_{SAT(Q1)} + V_{F(Q2)} + V_{F(Q3)} + V_{F(Q4)})$$

In addition, the relation of VR voltage to output voltage at V_{OMAX} or lower is expressed by:

$$V_{OH} = VR + (V_{F(Q5)} + V_{F(Q6)} + V_{F(Q7)}) - (V_{F(Q2)} + V_{F(Q3)} + V_{F(Q4)})$$

$$= VR + \Delta V_F \approx VR$$

ΔV_F depends on the output current but is nearly $V_{OH}=VR$. (Reference values; $V_{SAT} \approx 0.25V$, $V_F \approx 0.75V$)

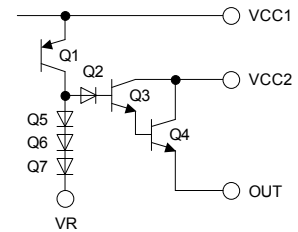

Fig. 17

b) BA6222

As the relationship between the output high voltage setting pin VR voltage and output high voltage V_{OH} is expressed by:

$$V_{OH} \approx 4 \times VR + V_{OFS}$$

In such event, V_{OFS} means the offset voltage, which varies in accord with output current and chip temperature.

The VR voltage region can be classified into three categories in accord with the output state:

- (A) Output high voltage 0V offset region
- (B) Fourfold gain region
- (C) Output voltage saturated region

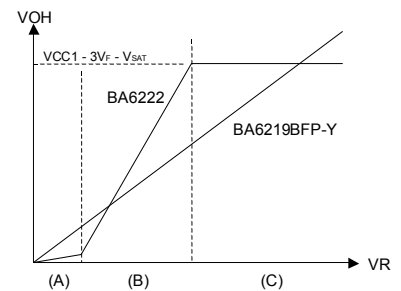

Fig. 18

Using this function with the VR pin connected to a load which has output impedance of several hundred ohms may result in oscillation. In such event, connect a capacitor of 3300pF or higher to about 0.1μF across VR and GND and make sure that the motor is free of oscillation.

c) Power supply voltage range of VR voltage

When output voltage control pin (VR) is used:

$$VR < VCC1 - (V_{SAT(Q1)} + V_{F(Q5)} + V_{F(Q6)} + V_{F(Q7)})$$

$$\approx VCC1 - 2.5V$$

$$VR < VCC2 - (V_{SAT(Q3)} - V_{F(Q3)} - V_{F(Q2)}) - (V_{F(Q5)} + V_{F(Q6)} + V_{F(Q7)})$$

$$\approx VCC2 - 1V$$

The output voltage control function does not operate in the region outside this range. In addition, when the VR pin is not used, use by shorting VR to VCC1.

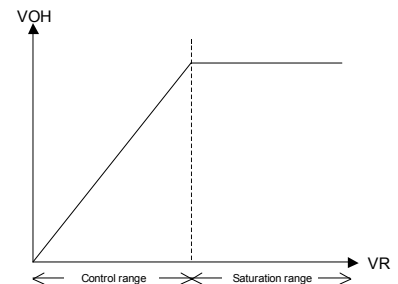

Fig. 19

3) Switching of rotating direction (FWD/REV)

When the rotating direction is changed over by the motor rotating condition, switch the direction after the motor is temporarily brought to the BRAKE condition or OPEN condition. It is recommended to keep the relevant conditions as follows:

- via BRAKE: Longer than braking time*.
(* the time required for the output L terminal to achieve potential below GND when brake is activated.)
- via OPEN: The time longer than 1 ms is recommended.

● Interfaces

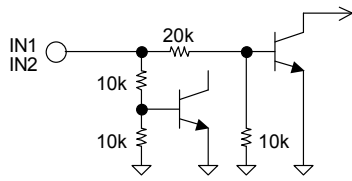

Fig. 20 IN1, IN2 (BA6219BFP-Y, BA6222)

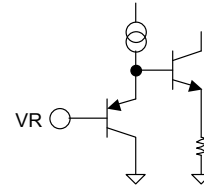

Fig.21 VR (BA6222)

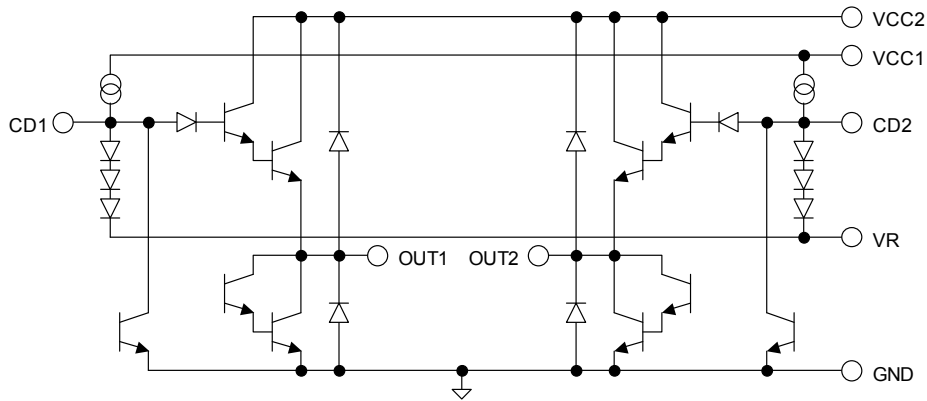

Fig. 22 VCC1, VCC2, VR, CD1, CD2, GND (BA6219BFP-Y)

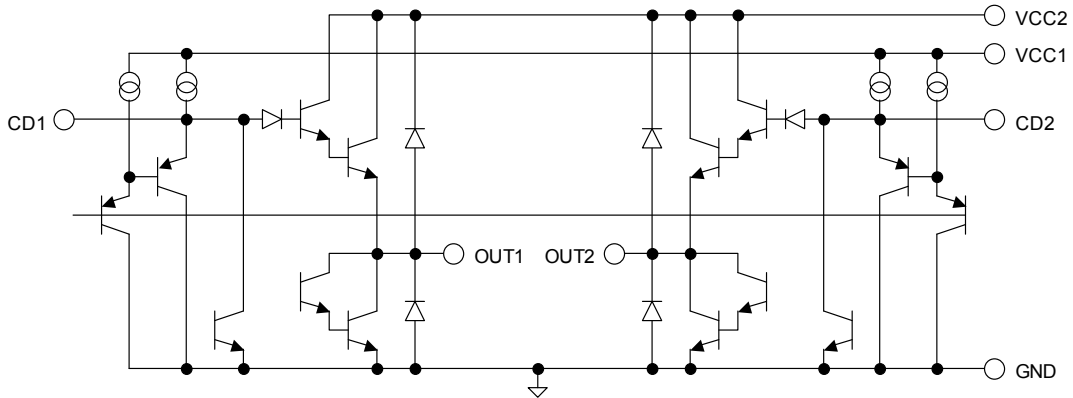

Fig. 23 VCC1, VCC2, CD1, CD2, GND (BA6222)

●Notes for use

1) Absolute maximum ratings

Devices may be destroyed when supply voltage or operating temperature exceeds the absolute maximum rating. Because the cause of this damage cannot be identified as, for example, a short circuit or an open circuit, it is important to consider circuit protection measures – such as adding fuses – if any value in excess of absolute maximum ratings is to be implemented.

2) Connecting the power supply connector backward

Connecting the power supply in reverse polarity can damage the IC. Take precautions against reverse polarity when connecting the power supply lines, such as adding an external direction diode.

3) Power supply lines

Return current generated by the motor's Back-EMF requires countermeasures, such as providing a return current path by inserting capacitors across the power supply and GND (10 μ F, ceramic capacitor is recommended). In this case, it is important to conclusively confirm that none of the negative effects sometimes seen with electrolytic capacitors – including a capacitance drop at low temperatures - occurs. Also, the connected power supply must have sufficient current absorbing capability. Otherwise, the regenerated current will increase voltage on the power supply line, which may in turn cause problems with the product, including peripheral circuits exceeding the absolute maximum rating. To help protect against damage or degradation, physical safety measures should be taken, such as providing a voltage clamping diode across the power supply and GND.

4) Electrical potential at GND

Keep the GND terminal potential to the minimum potential under any operating condition. In addition, check to determine whether there is any terminal that provides voltage below GND, including the voltage during transient phenomena. When both a small signal GND and high current GND are present, single-point grounding (at the set's reference point) is recommended, in order to separate the small signal and high current GND, and to ensure that voltage changes due to the wiring resistance and high current do not affect the voltage at the small signal GND. In the same way, care must be taken to avoid changes in the GND wire pattern in any external connected component.

5) Thermal design

Use a thermal design that allows for a sufficient margin in light of the power dissipation (Pd) under actual operating conditions.

6) Inter-pin shorts and mounting errors

Use caution when positioning the IC for mounting on printed circuit boards. The IC may be damaged if there is any connection error, or if pins are shorted together.

7) Operation in strong electromagnetic fields

Using this product in strong electromagnetic fields may cause IC malfunctions. Use extreme caution with electromagnetic fields.

8) ASO - Area of Safety Operation

When using the IC, set the output transistor so that it does not exceed absolute maximum ratings or ASO.

9) Built-in thermal shutdown (TSD) circuit

The TSD circuit is designed only to shut the IC off to prevent thermal runaway. It is not designed to protect the IC or guarantee its operation in the presence of extreme heat. Do not continue to use the IC after the TSD circuit is activated, and do not operate the IC in an environment where activation of the circuit is assumed.

	BA6219BFP-Y	BA6222
T _{ON} [°C]	180	150
T _{HYS} [°C]	15	15

*All temperature values are typical.

10) Capacitor between output and GND

In the event a large capacitor is connected between the output and GND, if VCC and VIN are short-circuited with 0V or GND for any reason, the current charged in the capacitor flows into the output and may destroy the IC. Use a capacitor smaller than 1 μ F between output and GND.

11) Testing on application boards

When testing the IC on an application board, connecting a capacitor to a low impedance pin subjects the IC to stress. Therefore, always discharge capacitors after each process or step. Always turn the IC's power supply off before connecting it to or removing it from the test setup during the inspection process. Ground the IC during assembly steps as an antistatic measure. Use similar precaution when transporting or storing the IC.

12) Regarding the input pin of the IC

This monolithic IC contains P+ isolation and P substrate layers between adjacent elements, in order to keep them isolated. P-N junctions are formed at the intersection of these P layers with the N layers of other elements, creating a parasitic diode or transistor. For example, the relation between each potential is as follows:

When $GND > Pin A$ and $GND > Pin B$, the P-N junction operates as a parasitic diode.

When $GND > Pin B$, the P-N junction operates as a parasitic transistor.

Parasitic diodes inevitably occur in the structure of the IC. The operation of parasitic diodes can result in mutual interference among circuits, as well as operating malfunctions and physical damage. Therefore, do not use methods by which parasitic diodes operate, such as applying a voltage lower than the GND (P substrate) voltage to an input pin.

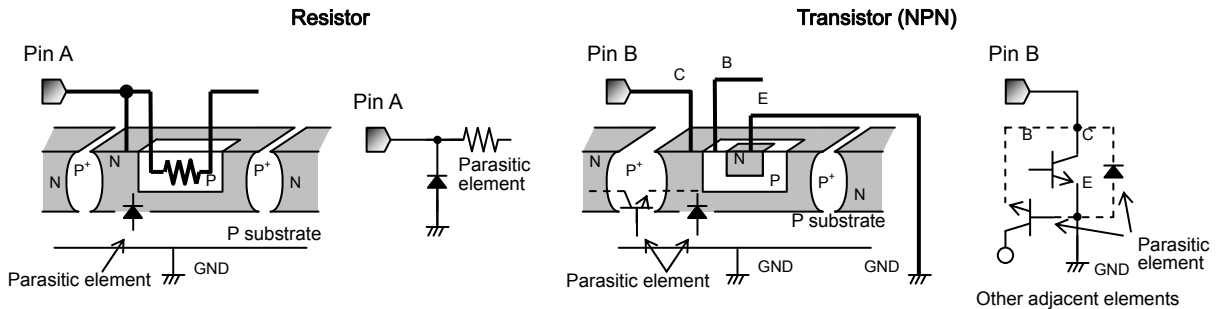

Appendix: Example of monolithic IC structure

●Ordering part number

B	A	6	2	1	9	B	F	P	-	Y	E	2
Part No.		Part No. 6219B 6222					Package FP-Y: HSOP25 None: HSIP10			Packaging and forming specification E2: Embossed tape and reel None: Tube		

HSOP25

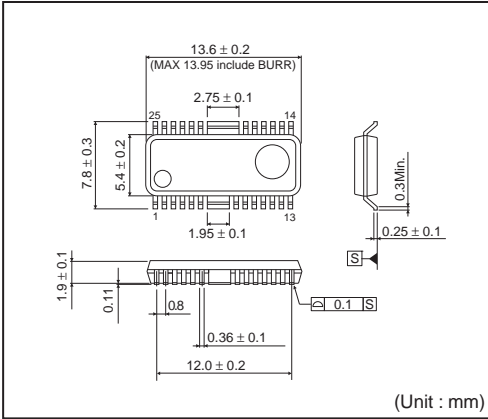

<Tape and Reel information>

Tape	Embossed carrier tape
Quantity	2000pcs
Direction of feed	E2 (The direction is the 1pin of product is at the upper left when you hold reel on the left hand and you pull out the tape on the right hand)

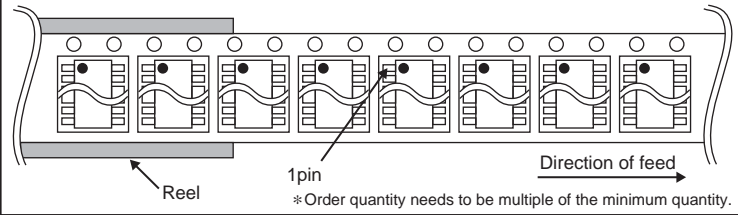

HSIP10

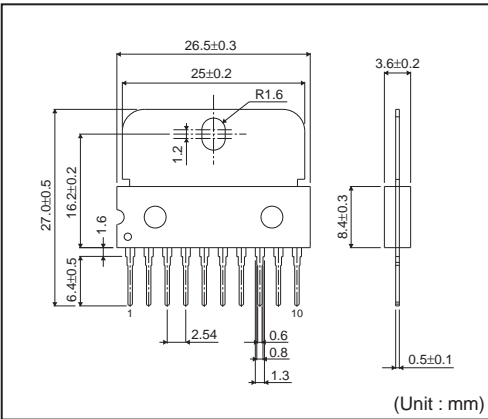

<Tape and Reel information>

Container	Tube
Quantity	500pcs
Direction of feed	Direction of products is fixed in a container tube

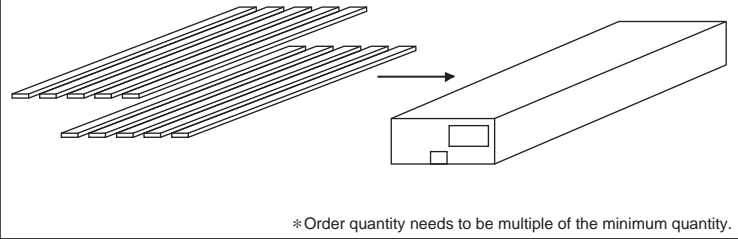

Notes

No copying or reproduction of this document, in part or in whole, is permitted without the consent of ROHM Co.,Ltd.

The content specified herein is subject to change for improvement without notice.

The content specified herein is for the purpose of introducing ROHM's products (hereinafter "Products"). If you wish to use any such Product, please be sure to refer to the specifications, which can be obtained from ROHM upon request.

Examples of application circuits, circuit constants and any other information contained herein illustrate the standard usage and operations of the Products. The peripheral conditions must be taken into account when designing circuits for mass production.

Great care was taken in ensuring the accuracy of the information specified in this document. However, should you incur any damage arising from any inaccuracy or misprint of such information, ROHM shall bear no responsibility for such damage.

The technical information specified herein is intended only to show the typical functions of and examples of application circuits for the Products. ROHM does not grant you, explicitly or implicitly, any license to use or exercise intellectual property or other rights held by ROHM and other parties. ROHM shall bear no responsibility whatsoever for any dispute arising from the use of such technical information.

The Products specified in this document are intended to be used with general-use electronic equipment or devices (such as audio visual equipment, office-automation equipment, communication devices, electronic appliances and amusement devices).

The Products specified in this document are not designed to be radiation tolerant.

While ROHM always makes efforts to enhance the quality and reliability of its Products, a Product may fail or malfunction for a variety of reasons.

Please be sure to implement in your equipment using the Products safety measures to guard against the possibility of physical injury, fire or any other damage caused in the event of the failure of any Product, such as derating, redundancy, fire control and fail-safe designs. ROHM shall bear no responsibility whatsoever for your use of any Product outside of the prescribed scope or not in accordance with the instruction manual.

The Products are not designed or manufactured to be used with any equipment, device or system which requires an extremely high level of reliability the failure or malfunction of which may result in a direct threat to human life or create a risk of human injury (such as a medical instrument, transportation equipment, aerospace machinery, nuclear-reactor controller, fuel-controller or other safety device). ROHM shall bear no responsibility in any way for use of any of the Products for the above special purposes. If a Product is intended to be used for any such special purpose, please contact a ROHM sales representative before purchasing.

If you intend to export or ship overseas any Product or technology specified herein that may be controlled under the Foreign Exchange and the Foreign Trade Law, you will be required to obtain a license or permit under the Law.



Thank you for your accessing to ROHM product informations.
More detail product informations and catalogs are available, please contact us.

ROHM Customer Support System

<http://www.rohm.com/contact/>