



AM/FM Car Antenna Low-Noise Amplifier

MAX2180

General Description

The MAX2180 is a highly integrated AM/FM variable-gain low-noise amplifier ideal for use in automotive active antenna applications. The device features separate AM and FM signal paths, each providing 30dB of gain range, controlled by individual on-chip power detectors. The AM signal path covers a 148kHz to 30MHz input frequency range, while the FM signal path covers 65MHz to 162.5MHz.

The device integrates a voltage regulator and pass transistor, allowing operation using battery voltages in the +8V to +24V range. On-chip thermal protection automatically limits junction temperatures during extreme thermal conditions.

The device is available in a small, 4mm x 4mm, TQFN package and operates over the extended industrial temperature range (-40°C to +85°C).

Applications

Automotive Active Antenna

Features

- ◆ +8V to +24V Supply Voltage Range
- ◆ Integrated AGC Function Eliminates External Pin Diodes
- ◆ High Dynamic Range
- ◆ Low-Noise Design
- ◆ Low External BOM
- ◆ Integrated Thermal Protection
- ◆ Small Package (4mm x 4mm TQFN)

Ordering Information

| PART | TEMP RANGE | PIN-PACKAGE |
|-------------|----------------|-------------|
| MAX2180ETG+ | -40°C to +85°C | 24 TQFN-EP* |

+ Denotes a lead(Pb)-free/ROHS-compliant package.
*EP = Exposed pad.

Simplified Block Diagram

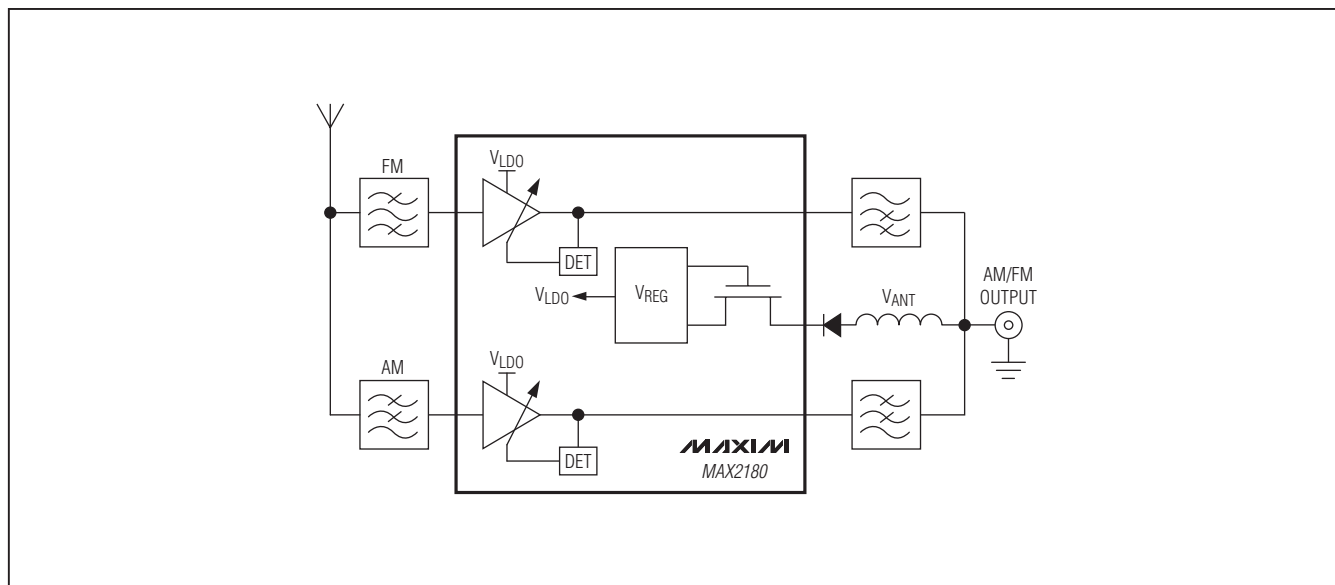

AM/FM Car Antenna Low-Noise Amplifier

ABSOLUTE MAXIMUM RATINGS

| | | | |
|---|---------------|---|-----------------|
| VBATT..... | -0.5V to +26V | θ_{JC} (Junction to Case) (Note 1)..... | 2°C/W |
| LDO..... | -0.5V to +6V | θ_{JA} (Junction to Ambient) (Note 1)..... | 36°C/W |
| FMOUT, AMOUT..... | -0.5V to VLDO | Operating Temperature Range..... | -40°C to +85°C |
| Short-Circuit Protection FMOUT, AMOUT..... | Indefinite | Junction Temperature..... | +150°C |
| FMIN, AMIN..... | 12Vpp | Storage Temperature Range..... | -65°C to +165°C |
| Continuous Power Dissipation ($T_A = +70^\circ\text{C}$) (derate 27.8mW/°C above +70°C)..... | 2220mW | Lead Temperature (TQFN only, soldering, 10s)..... | +300°C |
| | | Soldering Temperature (reflow)..... | +260°C |

Note 1: Package thermal resistances were obtained using the method described in JEDEC specification JESD51-7, using a four-layer board. For detailed information on package thermal considerations, refer to www.maxim-ic.com/thermal-tutorial.



CAUTION! ESD SENSITIVE DEVICE

Stresses beyond those listed under "Absolute Maximum Ratings" may cause permanent damage to the device. These are stress ratings only, and functional operation of the device at these or any other conditions beyond those indicated in the operational sections of the specifications is not implied. Exposure to absolute maximum rating conditions for extended periods may affect device reliability.

DC ELECTRICAL CHARACTERISTICS

(MAX2180 Evaluation Kit as shown, $V_{BATT} = 8\text{V}$ to 15V , $T_A = -40^\circ\text{C}$ to $+85^\circ\text{C}$, unless otherwise noted. Typical values are at $V_{BATT} = 10\text{V}$, $T_A = +25^\circ\text{C}$.) (Note 2)

| PARAMETER | CONDITIONS | MIN | TYP | MAX | UNITS |
|---|--|-----|------|-----|---------------|
| SUPPLY VOLTAGE (V_{BATT}) | | | | | |
| VBATT | Operational range | 8 | 10 | 15 | V |
| | Functional range (Note 3) | 15 | | 24 | |
| Voltage Regulation | VLDO (pin 15) | | 5.25 | | V |
| Supply Current | Normal operation ($V_{ANTSENSE} = 0\text{V}$ or $6\text{V} < V_{ANTSENSE} < 12\text{V}$) | | 78 | 95 | mA |
| | Antenna fault, ANTSENSE open | 10 | | 30 | |
| GAIN CONTROL AND AGC CONTROL (AM_GAIN, AM_DET, FM_DET, FM_GAIN, ANT_SENSE) | | | | | |
| ANTSENSE | Ground | -50 | | | μA |
| | Open | | 2.5 | | V |
| | LDO | | | 50 | μA |
| FMDET | Ground | -50 | | | μA |
| | LDO | | | 50 | |
| Digital Control | Ground | -50 | | | μA |
| | Open | | 2.5 | | V |
| | LDO | | | 50 | μA |

AC ELECTRICAL CHARACTERISTICS

(MAX2180 Evaluation Kit, $T_A = -40^\circ\text{C}$ to $+85^\circ\text{C}$, $V_{BATT} = 8\text{V}$ to 15V , unless otherwise noted. Typical values are at $V_{BATT} = 10\text{V}$, $T_A = +25^\circ\text{C}$, load impedance = 50Ω , AM channel bandwidth = 9kHz , RAM = 10Ω (AM gain = 6dB), FM low-gain configuration, FM gain = 6dB .) (Note 2)

| PARAMETER | CONDITIONS | MIN | TYP | MAX | UNITS |
|----------------------|--|-------|------|------|----------|
| AM AMPLIFIER | | | | | |
| Frequency Range | | 0.148 | | 30 | MHz |
| Voltage Gain Maximum | RAM = short, $f_{IN} = 1\text{MHz}$ | 5 | 6.5 | 8 | dB |
| Voltage Gain Minimum | RAM = 330Ω , $f_{IN} = 1\text{MHz}$ | -2.8 | -1.3 | +0.2 | dB |
| Input Capacitance | $f_{IN} = 1\text{MHz}$ | | 12.5 | | pF |
| Output Impedance | $f_{IN} = 1\text{MHz}$ | | | 17 | Ω |

AM/FM Car Antenna Low-Noise Amplifier

MAX2180

AC ELECTRICAL CHARACTERISTICS (continued)

(MAX2180 Evaluation Kit, $T_A = -40^{\circ}\text{C}$ to $+85^{\circ}\text{C}$, $V_{BATT} = 8\text{V}$ to 15V , unless otherwise noted. Typical values are at $V_{BATT} = 10\text{V}$, $T_A = +25^{\circ}\text{C}$, load impedance = 50Ω , AM channel bandwidth = 9kHz , $R_{AM} = 10\Omega$ (AM gain = 6dB), FM low-gain configuration, FM gain = 6dB .) (Note 2)

| PARAMETER | CONDITIONS | MIN | TYP | MAX | UNITS |
|-------------------------------------|--|------|------|-------|------------------|
| Gain Response (Relative to 1MHz) | 0.148MHz to 0.285MHz (Note 4) | -1 | | +1 | dB |
| | 0.520MHz to 1.710MHz (Note 4) | -1 | | +1 | |
| | 5.9MHz to 20MHz (Note 4) | -2.7 | | +1 | |
| | 20MHz to 30MHz | -4 | | +1 | |
| Gain Control Range | At 1MHz | 35 | 40 | | dB |
| Output Noise | 0.148MHz to 0.285MHz | | -5 | | dB μV |
| | 0.520MHz to 1.710MHz | | -8 | | |
| | 5.90MHz to 30MHz | | -8 | | |
| IMD2 | $V_{IN} = +120\text{dB}\mu\text{V}/\text{tone}$, $+86\text{dB}\mu\text{V}$ AGC threshold, 0.4MHz and 0.5MHz tones | | -70 | | dB |
| IMD3 | $V_{IN} = +120\text{dB}\mu\text{V}/\text{tone}$, $+86\text{dB}\mu\text{V}$ AGC threshold, 0.4MHz and 0.5MHz tones | | -66 | | dB |
| AGC Threshold | Output level, $f_{IN} = 1\text{MHz}$, AMDET connected to ground | | 79 | | dB μV |
| | Output level, $f_{IN} = 1\text{MHz}$, AMDET open | | 83 | | |
| | Output level, $f_{IN} = 1\text{MHz}$, AMDET connected to LDO | | 86 | | |
| AGC Threshold Variation | Relative to 1MHz tone ($148\text{kHz} < f_{IN} < 1710\text{kHz}$) | | 2.2 | | dB |
| FM AMPLIFIER | | | | | |
| Frequency Range | | 76 | | 162.5 | MHz |
| Power Gain Maximum | $f_{IN} = 97\text{MHz}$, FMGAIN connected to LDO | 6.5 | 8.5 | 10 | dB |
| | $f_{IN} = 97\text{MHz}$, FMGAIN connected to LDO, FM high-gain configuration (Note 5) | | 10.5 | | |
| Power Gain Minimum | $f_{IN} = 97\text{MHz}$, FMGAIN = short | 4.0 | 5.8 | 7.6 | dB |
| Gain Flatness | 76MHz to 90MHz (Note 4) | | | 0.5 | dB |
| | 87MHz to 108MHz (Note 4) | | | 0.5 | |
| | 162.5MHz relative to 97MHz | | | 2.5 | |
| Noise Figure | $f_{IN} = 97\text{MHz}$, $T_A = +25^{\circ}\text{C}$ (Note 5) | | 3.7 | | dB |
| Input Return Loss | 50Ω source | | 12 | | dB |
| Output Return Loss | 50Ω load | | 12 | | dB |
| Gain Control Range | $f_{IN} = 97\text{MHz}$ | 26 | 29 | | dB |
| IMD2 (FM to AM) | Output tones of 107MHz and 108MHz, $+100\text{dB}\mu\text{V}$ AGC threshold (A - B) | | 26 | | dB μV |
| IMD3 | $V_{IN} = +120\text{dB}\mu\text{V}/\text{tone}$, $+100\text{dB}\mu\text{V}$ AGC threshold, 107MHz and 108MHz tones | | 66 | | dB |
| | $V_{IN} = +120\text{dB}\mu\text{V}/\text{tone}$, $+100\text{dB}\mu\text{V}$ AGC threshold, 107MHz and 108MHz tones, FM high-gain configuration (Note 5) | | 63 | | |
| AGC Threshold | Minimum output threshold | | 90 | | dB μV |
| | Maximum output threshold | | 104 | | |
| AGC Threshold Variation | Relative to 97MHz tone (76MHz to 108MHz) | | 1 | | dB |

Note 2: Min and max values are production tested at $T_A = +25^{\circ}\text{C}$ and $+85^{\circ}\text{C}$. Min and Max limits at $T_A = -40^{\circ}\text{C}$ are guaranteed by design and characterization.

Note 3: Device automatically reduces current to limit die temperature within a safe range, but otherwise remains functional.

Note 4: Guaranteed by design and characterization.

Note 5: FM high-gain configuration. See the MAX2180 Evaluation Kit schematic.

AM/FM Car Antenna Low-Noise Amplifier

Typical Operating Characteristics

(MAX2180 Evaluation Kit, low-gain configuration, $V_{BATT} = 10V$, $T_A = +25^\circ C$, unless otherwise noted.)

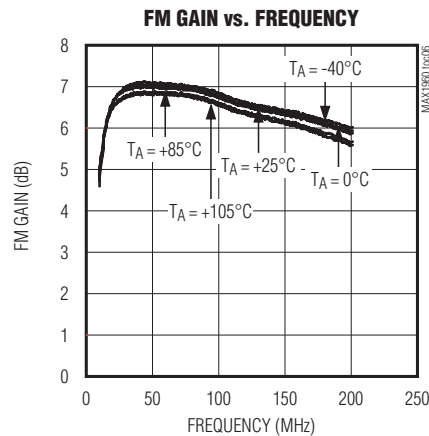
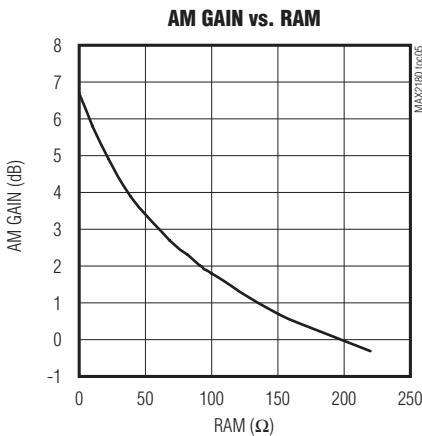
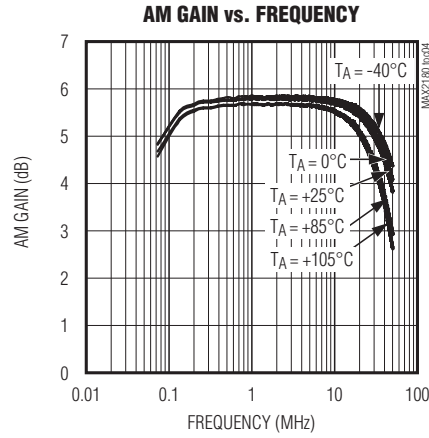
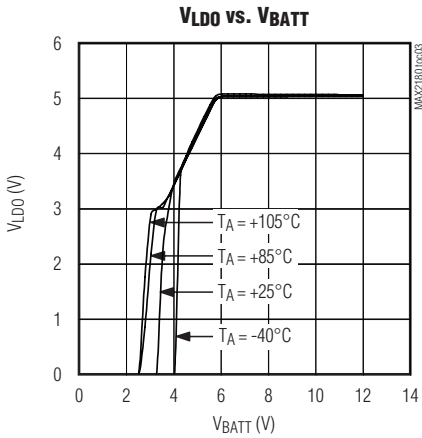
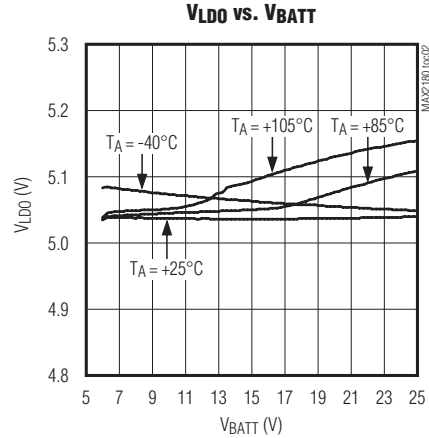
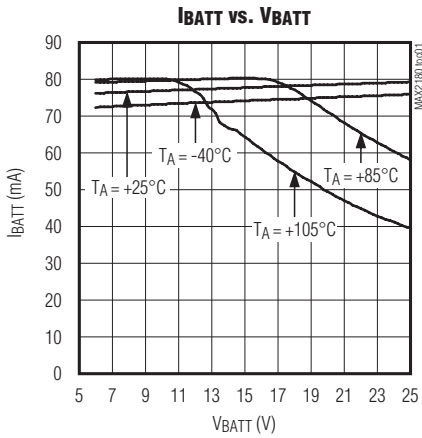

AM/FM Car Antenna Low-Noise Amplifier

Typical Operating Characteristics (continued)

(MAX2180 Evaluation Kit, low-gain configuration, $V_{BATT} = 10V$, $T_A = +25^\circ C$, unless otherwise noted.)

MAX2180

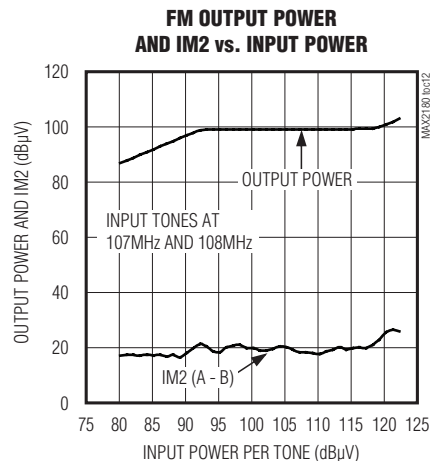
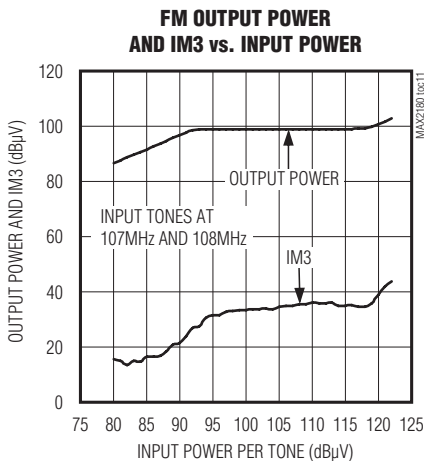
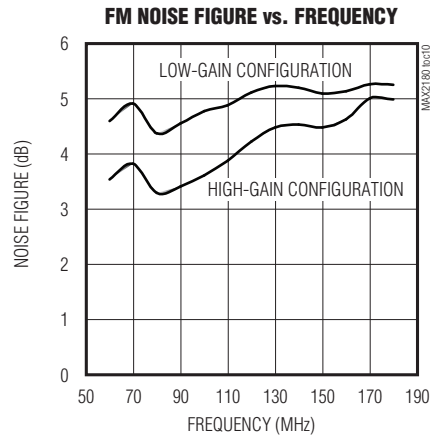
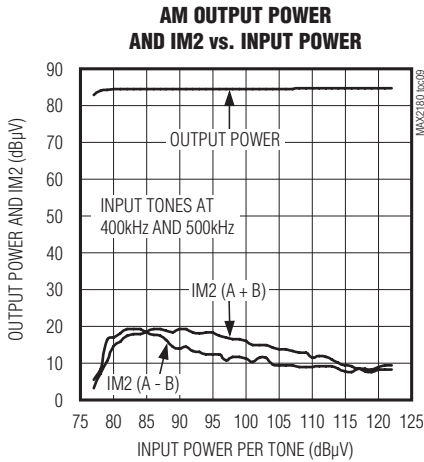
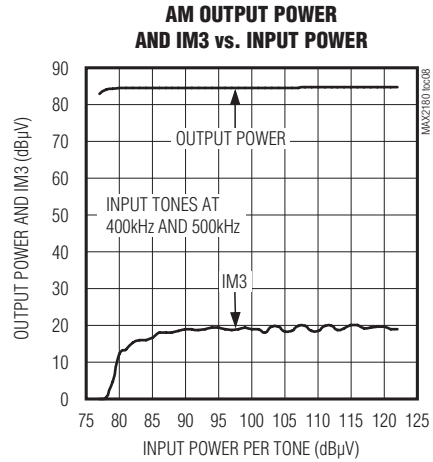
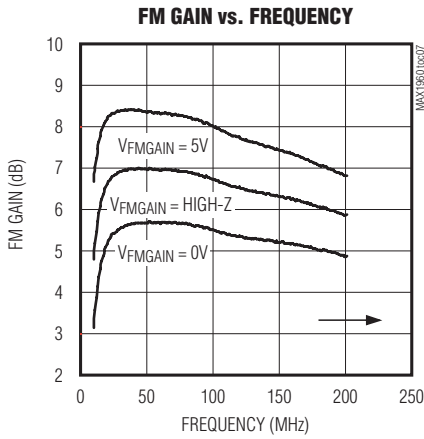

AM/FM Car Antenna Low-Noise Amplifier

Pin Configuration

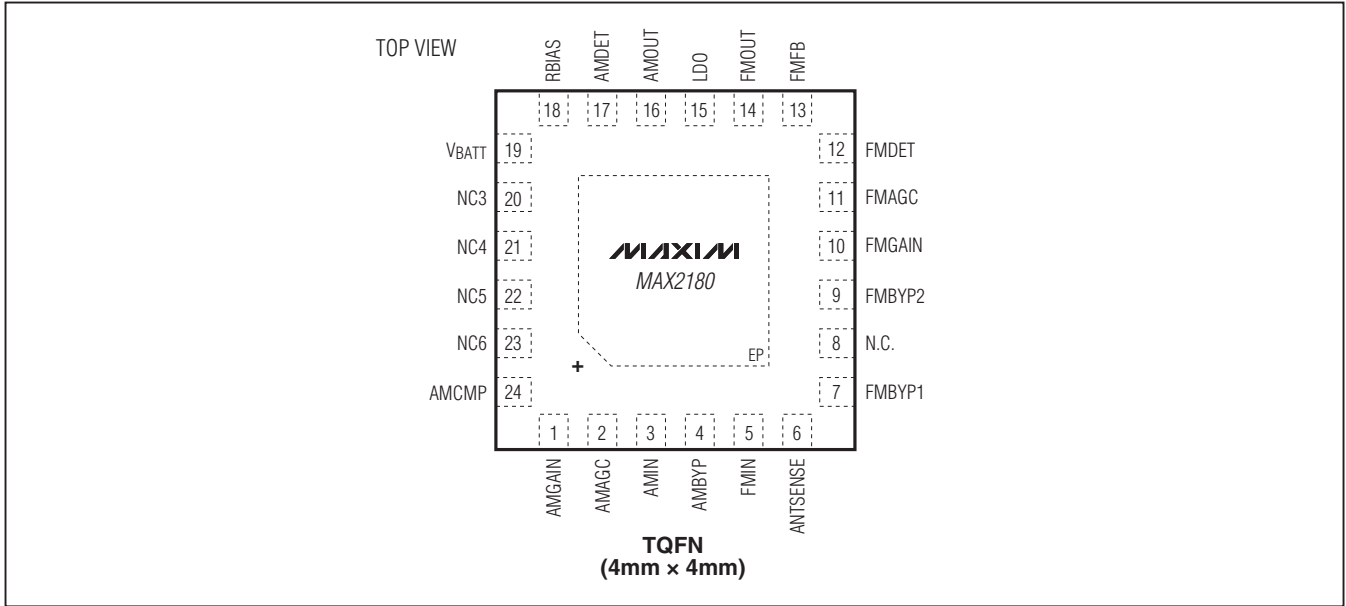

Pin Description

| PIN | NAME | DESCRIPTION |
|-----|----------|--|
| 1 | AMGAIN | AM Gain Adjust. Per Table 1, place resistor to ground for desired voltage gain. See the <i>Detailed Description</i> section. |
| 2 | AMAGC | AM AGC AC Ground. Connect a 0.1 μ F capacitor to ground. |
| 3 | AMIN | AM Input. AC-couple to AM input lowpass filter. |
| 4 | AMBYP | AM AC Ground. Connect a 0.1 μ F capacitor to ground. |
| 5 | FMIN | FM Input. AC-couple to FM input bandpass filter. |
| 6 | ANTSENSE | Connect to Antenna Input Connector Center Conductor Through a 100k Ω Resistor. See the <i>Detailed Description</i> section. |
| 7 | FMBYP1 | FM AC Ground. Connect a 100pF capacitor to ground. |
| 8 | N.C. | No Connection to Die |
| 9 | FMBYP2 | FM AC Ground. Connect a 100pF capacitor to ground. |
| 10 | FMGAIN | FM Gain Adjust. Connect to ground, leave open, or connect to LDO for the desired FM gain. See the <i>Detailed Description</i> section. |
| 11 | FMAGC | FM AGC AC Ground. Connect a 0.1 μ F capacitor to ground. |
| 12 | FMDET | FM Attack Point Adjust. Connect the desired resistor to ground. See the <i>Detailed Description</i> section. |
| 13 | FMFB | FM Feedback. Connect through resistor RFM and a 2200pF capacitor to FMOUT. See the <i>MAX2180 Evaluation Kit</i> schematic. |
| 14 | FMOUT | FM Output |
| 15 | LDO | DC Regulator Output. Connect a 10 μ F and 1000pF capacitor to ground. |
| 16 | AMOUT | AM Output |
| 17 | AMDET | AM Attack Point Adjust. Connect to ground, leave open, or connect to LDO for the desired AM attack point. See the <i>Detailed Description</i> section. |

AM/FM Car Antenna Low-Noise Amplifier

MAX2180

Pin Description (continued)

| PIN | NAME | DESCRIPTION |
|----------------|--------------------|---|
| 18 | RBIAS | Connect a 1% Tolerance 20k Ω Resistor to Ground |
| 19 | VBATT | Battery Supply |
| 20, 21, 22, 23 | NC3, NC4, NC5, NC6 | No Connection to Die. Use as a thermal path on layer 1 of PCB from exposed pad to thermal sink. |
| 24 | AMCMP | AM Compensation. Leave open for RAM < 68 Ω and short for RAM \geq 68 Ω . See the <i>Detailed Description</i> section. |
| — | EP | Exposed Pad. Ground. |

Detailed Description

Setting Signal Path Gain and AGC Attack Point

The MAX2180 allows independent variation of the gain and AGC attack points on the AM and FM signal paths. Gain and attack point are adjusted by changing the conditions on the AMGAIN, AMDET, FMGAIN, and FMDET pins.

AM Signal Path

The gain of the AM signal path is adjusted by changing the resistor RAM, which is connected to AMGAIN through a 0.1 μ F capacitor. Table 1 shows the gain associated with several resistor values. The output attack point of the AM signal path can be set to one of three values depending on the state of the AMDET pin, as shown in Table 2.

Table 1. AM Signal Path Gain

| RAM (Ω) | AM GAIN (dB, TYP) |
|------------------|-------------------|
| 0 | 6.5 |
| 22 | 5 |
| 68 | 2.5 |
| 180 | 0.5 |
| 330 | -1 |

Table 2. AM Signal Path Attack Point

| PIN AMDET | AM OUTPUT ATTACK POINT (dB μ V, TYP) |
|-----------|--|
| Ground | 79 |
| Open | 83 |
| VLDO | 86 |

Note: For values of RAM \geq 68 Ω , pin AMCMP must be shorted to ground. For values of RAM < 68 Ω , leave AMCMP open.

FM Signal Path

The FM signal path can be configured for either high-gain or low-gain operation. In the high-gain configuration, typical FM gain is 10.5dB. In the low-gain configuration, typical FM gain can be set using the FMGAIN pin as shown in Table 3. Component values for high-gain and low-gain configurations are shown in Table 5.

The output attack point of the FM signal path is adjusted by changing the resistor RFMDDET, connected to the FMDET pin. Table 4 shows the attack point associated with several resistor values.

Table 3. FM Signal Path Gain

| PIN FMGAIN | FM GAIN (dB, TYP) |
|------------|-------------------|
| Ground | 8.5 |
| Open | 7.1 |
| VLDO | 5.8 |

Table 4. FM Signal Path Attack Point

| RFMDDET (k Ω) | FM OUTPUT ATTACK POINT (dB μ V, TYP) |
|-----------------------|--|
| 0 | 104 |
| 10 | 100 |
| 18 | 96 |
| 27 | 95 |
| 39 | 94 |
| 47 | 93 |
| 56 | 92 |
| 68 | 90 |

AM/FM Car Antenna Low-Noise Amplifier

Antenna Sensing

In some applications, a bias voltage might be present on the car antenna or the car antenna might be DC shorted to ground in normal operation. In these situations, the device can sense an antenna fault condition and report this by setting the VBATT current.

Connecting the ANTSENSE pin to the car antenna through a 100k Ω resistor enables this function. If a DC bias of 6V to 12V is present on the antenna, the device operates normally. If the antenna is DC shorted to ground, the device also operates normally. However, if the antenna is a DC open circuit, the device VBATT current drops to a value between 10mA to 30mA. This provides a method for the car audio system to detect an antenna fault. If this function is not required, the ANTSENSE pin should be connected to ground.

Layout Recommendations

For best performance, the device must be mounted on a PCB which is designed for a low thermal resistance. A thermal ground must be placed near the device. This

can consist of a mounting screw to a large thermal mass, ideally placed no more than 5mm from the package. The backside ground of the MAX2180 must be connected to a thermal ground plane on the PCB using at least nine plated through holes. Finally, a wide trace on the PCB top metal from the paddle area, connecting pins 20–23, and proceeding to the mounting hole further improves thermal performance.

The MAX2180 is equipped with thermal-protection circuitry that maintains junction temperature at safe levels when the device is operated outside its specified operating range. For ambient temperatures up to +85°C and VBATT up to +15V, the thermal protection does not engage.

Refer to www.maxim-ic.com for the MAX2180 Evaluation Kit schematic, Gerber data, PADS layout file, and BOM information.

Package Information

For the latest package outline information and land patterns, go to www.maxim-ic.com/packages. Note that a "+", "#", or "-" in the package code indicates RoHS status only. Package drawings may show a different suffix character, but the drawing pertains to the package regardless of RoHS status.

Table 5. FM Signal Path Component Values

| COMPONENT | HIGH-GAIN CONFIGURATION | LOW-GAIN CONFIGURATION |
|-----------|-------------------------|------------------------|
| C1 | 82pF | 1000pF |
| C2 | 1000pF | Open |
| C3 | 33pF | 1000pF |
| R1 | 200 Ω | Open |
| RFM | 390 Ω | Short |
| L1 | 100nH | Open |
| L2 | 150nH | 2200nH |

| PACKAGE TYPE | PACKAGE CODE | OUTLINE NO. | LAND PATTERN NO. |
|--------------|--------------|-------------------------|-------------------------|
| 24 TQFN | T2444+3 | 21-0139 | 90-0068 |

AM/FM Car Antenna Low-Noise Amplifier

MAX2180 Evaluation Kit

MAX2180

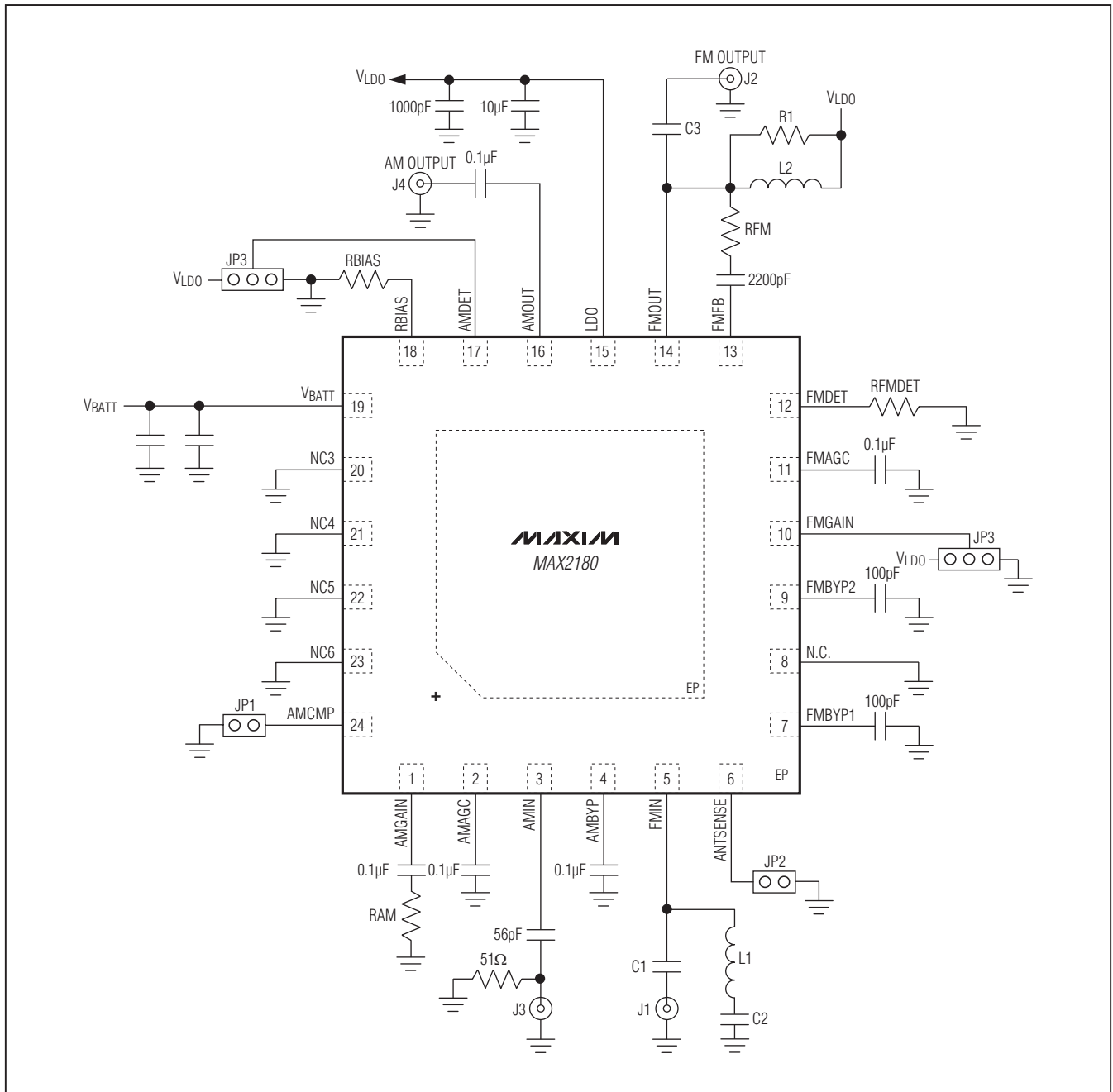

AM/FM Car Antenna Low-Noise Amplifier

Revision History

| REVISION NUMBER | REVISION DATE | DESCRIPTION | PAGES CHANGED |
|------------------------|----------------------|--------------------|----------------------|
| 0 | 6/10 | Initial release | — |

Maxim cannot assume responsibility for use of any circuitry other than circuitry entirely embodied in a Maxim product. No circuit patent licenses are implied. Maxim reserves the right to change the circuitry and specifications without notice at any time.

10 _____ **Maxim Integrated Products, 120 San Gabriel Drive, Sunnyvale, CA 94086 408-737-7600**