

National Semiconductor is now part of
Texas Instruments.

Search <http://www.ti.com/> for the latest technical
information and details on our current products and services.

LM4889 Boomer® Audio Power Amplifier Series

1 Watt Audio Power Amplifier

General Description

The LM4889 is an audio power amplifier primarily designed for demanding applications in mobile phones and other portable communication device applications. It is capable of delivering 1 watt of continuous average power to an 8Ω BTL load with less than 2% distortion (THD+N) from a 5V_{DC} power supply.

Boomer audio power amplifiers were designed specifically to provide high quality output power with a minimal amount of external components. The LM4889 does not require output coupling capacitors or bootstrap capacitors, and therefore is ideally suited for mobile phone and other low voltage applications where minimal power consumption is a primary requirement.

The LM4889 features a low-power consumption shutdown mode, which is achieved by driving the shutdown pin with a logic low. Additionally, the LM4889 features an internal thermal shutdown protection mechanism.

The LM4889 contains advanced pop & click circuitry to eliminate noise which would otherwise occur during turn-on and turn-off transitions.

The LM4889 is unity-gain stable and can be configured by external gain-setting resistors.

Key Specifications

- Improved PSRR at 217Hz, 5 - 3.3V 75dB
- Power Output at 5.0V & 2% THD 1.0W(typ.)
- Power Output at 3.3V & 1% THD 400mW(typ.)
- Shutdown Current at 3.3 & 2.6V 0.01μA(typ.)

Features

- Available in space-saving MSOP, SOIC, LLP, and micro SMD packages
- Ultra low current shutdown mode (3.3 to 2.6V - 0.01μA)
- Can drive capacitive loads up to 500 pF
- Improved pop & click circuitry eliminates noises during turn-on and turn-off transitions
- 2.2 - 5.5V operation
- No output coupling capacitors, snubber networks or bootstrap capacitors required
- Unity-gain stable
- External gain configuration capability

Applications

- Mobile Phones
- PDAs
- Portable electronic devices

Typical Application

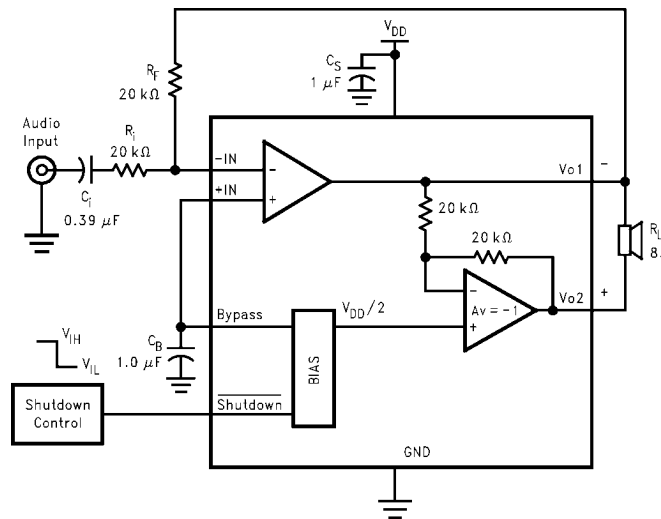

20035801

FIGURE 1. Typical Audio Amplifier Application Circuit

Connection Diagrams

Small Outline (SO) Package

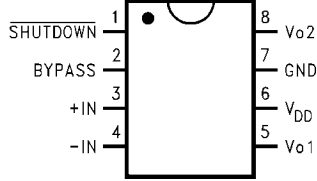

20035835

Top View
Order Number LM4889MA
See NS Package Number M08A

SO Marking

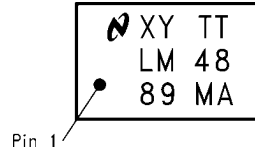

20035872

Top View
XY - Date Code
TT - Die Traceability
Bottom 2 lines - Part Number

Mini Small Outline (MSOP) Package

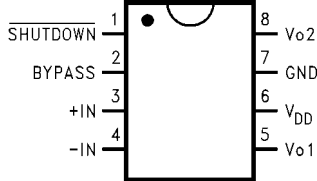

20035836

Top View
Order Number LM4889MM
See NS Package Number MUA08A

MSOP Marking

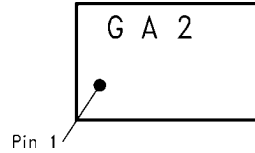

20035871

Top View
G - Boomer Family
A2 - LM4889MM

8 Bump micro SMD

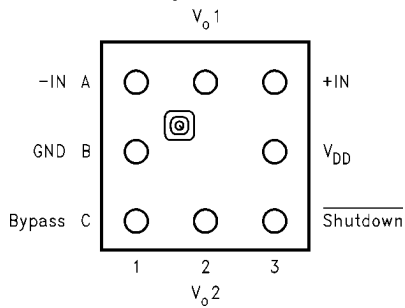

20035887

Top View
Order Number LM4889ITL, LM4889ITLX
See NS Package Number TLA08AAA

8 Bump micro SMD Marking

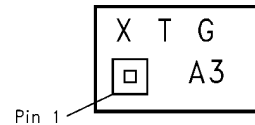

20035879

Top View
X - Date Code
T - Die Traceability
G - Boomer Family
A3 - LM4889ITL

LLP Package

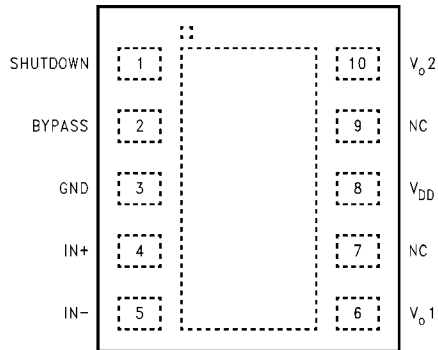

20035830

Top View
Order Number LM4889LD
See NS Package Number LDA10B

10 Pin LLP Marking

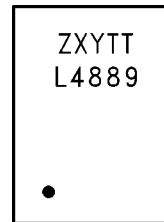

20035831

Top View
Z - Assembly Plant Date Code (M for Malacca)
XY - 2 Digit Date Code
TT - Die Traceability
L4889 - LM4889LD

Absolute Maximum Ratings (Note 2)

If Military/Aerospace specified devices are required, please contact the National Semiconductor Sales Office/Distributors for availability and specifications.

Supply Voltage	6.0V
Storage Temperature	-65°C to +150°C
Input Voltage	-0.3V to $V_{DD} + 0.3V$
Power Dissipation (Note 3)	Internally Limited
ESD Susceptibility (Note 4)	2000V
ESD Susceptibility (Note 5)	200V
Junction Temperature	150°C
Thermal Resistance	
θ_{JC} (SOP)	35°C/W
θ_{JA} (SOP)	150°C/W

θ_{JA} (8 Bump micro SMD) (Note 10)	210°C/W
θ_{JC} (MSOP)	56°C/W
θ_{JA} (MSOP)	190°C/W
θ_{JA} (LLP)	220°C/W

Soldering Information

See AN-1112 "microSMD Wafers Level Chip Scale Package".

Operating Ratings

Temperature Range

$T_{MIN} \leq T_A \leq T_{MAX}$	$-40^\circ\text{C} \leq T_A \leq 85^\circ\text{C}$
Supply Voltage	$2.2V \leq V_{DD} \leq 5.5V$

Electrical Characteristics $V_{DD} = 5V$

Symbol	Parameter	Conditions	LM4889		Units (Limits)
			Typical	Limit	
			(Note 6)	(Notes 7, 9)	
I_{DD}	Quiescent Power Supply Current	$V_{IN} = 0V, I_o = 0A, \text{ no Load}$	4	8	mA (max)
		$V_{IN} = 0V, I_o = 0A, \text{ with BTL Load}$	5	8	mA (max)
I_{SD}	Shutdown Current	$V_{\text{shutdown}} = \text{GND}$ (Note 8)	0.1	2	μA (max)
V_{SDIH}	Shutdown Voltage Input High			1.2	V (min)
V_{SDIL}	Shutdown Voltage Input Low			0.4	V (max)
P_o	Output Power	THD = 2% (max); $f = 1 \text{ kHz}$	1		W
THD+N	Total Harmonic Distortion+Noise	$P_o = 0.4 \text{ Wrms}; f = 1 \text{ kHz}$	0.1		%
PSRR	Power Supply Rejection Ratio	$V_{\text{ripple}} = 200\text{mV sine p-p}$ $f_{\text{ripple}} = 217\text{Hz}$ $f_{\text{ripple}} = 1\text{kHz}$	62		dB
		$V_{\text{ripple}} = 200\text{mV sine p-p}$ $f_{\text{ripple}} = 1\text{kHz}$	66		dB
		$V_{\text{ripple}} = 200\text{mV sine p-p}$ Input Floating	75	68	dB

Electrical Characteristics $V_{DD} = 3.3V$

Symbol	Parameter	Conditions	LM4889		Units (Limits)
			Typical	Limit	
			(Note 6)	(Notes 7, 9)	
I_{DD}	Quiescent Power Supply Current	$V_{IN} = 0V, I_o = 0A, \text{ no Load}$	3.5	7	mA (max)
		$V_{IN} = 0V, I_o = 0A, \text{ with BTL Load}$	4.5	7	mA (max)
I_{SD}	Shutdown Current	$V_{\text{shutdown}} = \text{GND}$ (Note 8)	0.01	2	μA (max)
V_{SDIH}	Shutdown Voltage Input High			1.2	V (min)
V_{SDIL}	Shutdown Voltage Input Low			0.4	V (max)
P_o	Output Power	THD = 1% (max); $f = 1 \text{ kHz}$	0.4		W
THD+N	Total Harmonic Distortion+Noise	$P_o = 0.25\text{Wrms}; f = 1 \text{ kHz}$	0.1		%
PSRR	Power Supply Rejection Ratio	$V_{\text{ripple}} = 200\text{mV sine p-p}$ $f_{\text{ripple}} = 217\text{Hz}$ $f_{\text{ripple}} = 1\text{kHz}$	60		dB
		$V_{\text{ripple}} = 200\text{mV sine p-p}$ $f_{\text{ripple}} = 1\text{kHz}$	62		dB
		$V_{\text{ripple}} = 200\text{mV sine p-p}$ Input Floating			

Electrical Characteristics $V_{DD} = 2.6V$

Symbol	Parameter	Conditions	LM4889		Units (Limits)
			Typical	Limit	
			(Note 6)	(Notes 7, 9)	
I_{DD}	Quiescent Power Supply Current	$V_{IN} = 0V, I_o = 0A$, no Load	2.6	6	mA (max)
		$V_{IN} = 0V, I_o = 0A$, with BTL Load	3.0	6	mA (max)
I_{SD}	Shutdown Current	$V_{shutdown} = GND$ (Note 8)	0.01	2	μA (max)
P_o	Output Power (8Ω)	THD = 1% (max); f = 1 kHz	0.2		W
	Output Power (4Ω)	THD = 1% (max); f = 1 kHz	0.22		W
THD+N	Total Harmonic Distortion+Noise	$P_o = 0.1W_{rms}$; f = 1kHz	0.08		%
PSRR	Power Supply Rejection Ratio	$V_{ripple} = 200mV$ sine p-p			
		$f_{ripple} = 217Hz$	44		dB
		$f_{ripple} = 1kHz$	44		dB

Note 1: All voltages are measured with respect to the ground pin, unless otherwise specified.

Note 2: *Absolute Maximum Ratings* indicate limits beyond which damage to the device may occur. *Operating Ratings* indicate conditions for which the device is functional, but do not guarantee specific performance limits. *Electrical Characteristics* state DC and AC electrical specifications under particular test conditions which guarantee specific performance limits. This assumes that the device is within the Operating Ratings. Specifications are not guaranteed for parameters where no limit is given, however, the typical value is a good indication of device performance.

Note 3: The maximum power dissipation must be derated at elevated temperatures and is dictated by T_{JMAX} , θ_{JA} , and the ambient temperature T_A . The maximum allowable power dissipation is $P_{DMAX} = (T_{JMAX} - T_A) / \theta_{JA}$ or the number given in Absolute Maximum Ratings, whichever is lower. For the LM4889, see power derating currents for additional information.

Note 4: Human body model, 100 pF discharged through a 1.5 k Ω resistor.

Note 5: Machine Model, 220 pF–240 pF discharged through all pins.

Note 6: Typical values are measured at 25°C and represent the parametric norm.

Note 7: Limits are guaranteed to National's AOQL (Average Outgoing Quality Level).

Note 8: For micro SMD only, shutdown current is measured in a Normal Room Environment. Exposure to direct sunlight will increase I_{SD} by a maximum of 2 μA .

Note 9: Datasheet min/max specification limits are guaranteed by design, test or statistical analysis.

Note 10: All bumps have the same thermal resistance and contribute equally when used to lower thermal resistance. The LM4889ITL demo board (views featured in the **Application Information** section) has two inner layers, one for V_{DD} and one for GND. The planes each measure 600mils x 600mils (15.24mm x 15.24mm) and aid in spreading heat due to power dissipation within the IC.

External Components Description

(Figure 1)

Components		Functional Description
1.	R_i	Inverting input resistance which sets the closed-loop gain in conjunction with R_f . This resistor also forms a high pass filter with C_i at $f_c = 1/(2\pi R_i C_i)$.
2.	C_i	Input coupling capacitor which blocks the DC voltage at the amplifiers input terminals. Also creates a highpass filter with R_i at $f_c = 1/(2\pi R_i C_i)$. Refer to the section, Proper Selection of External Components , for an explanation of how to determine the value of C_i .
3.	R_f	Feedback resistance which sets the closed-loop gain in conjunction with R_i . $A_{VD} = 2*(R_f/R_i)$.
4.	C_S	Supply bypass capacitor which provides power supply filtering. Refer to the Power Supply Bypassing section for information concerning proper placement and selection of the supply bypass capacitor.
5.	C_B	Bypass pin capacitor which provides half-supply filtering. Refer to the section, Proper Selection of External Components , for information concerning proper placement and selection of C_B .

Typical Performance Characteristics

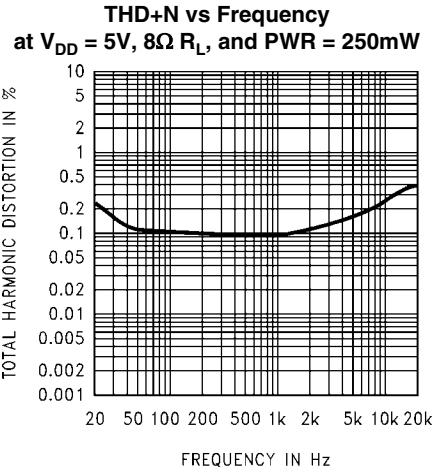

20035837

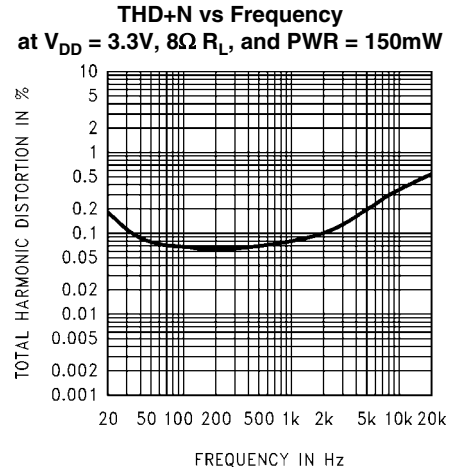

20035838

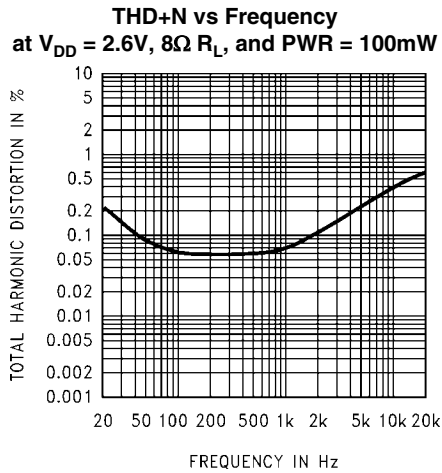

20035839

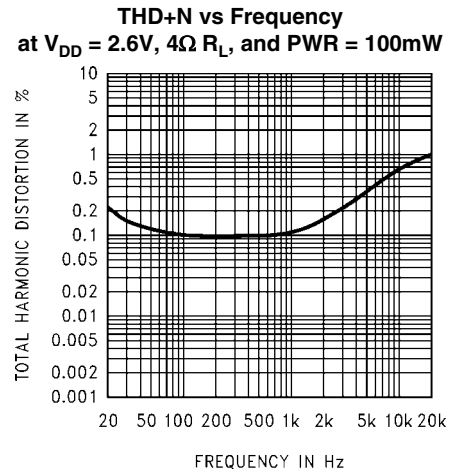

20035840

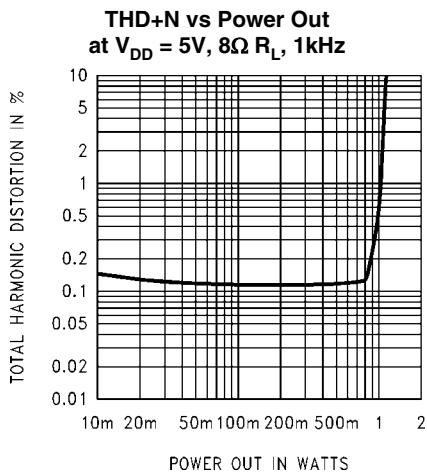

20035875

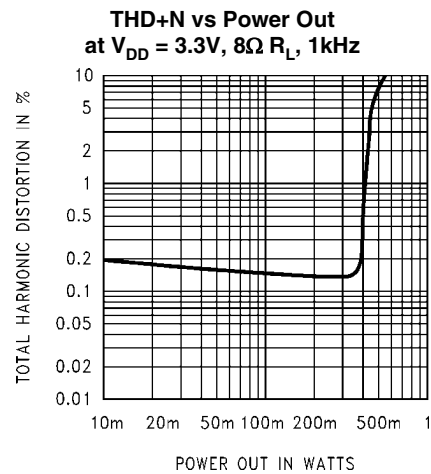

20035842

THD+N vs Power Out
at $V_{DD} = 2.6V$, $8\Omega R_L$, 1kHz

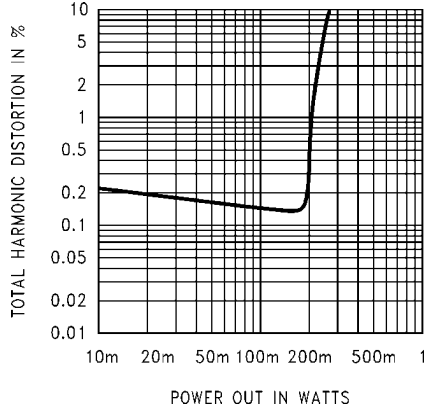

20035843

THD+N vs Power Out
at $V_{DD} = 2.6V$, $4\Omega R_L$, 1kHz

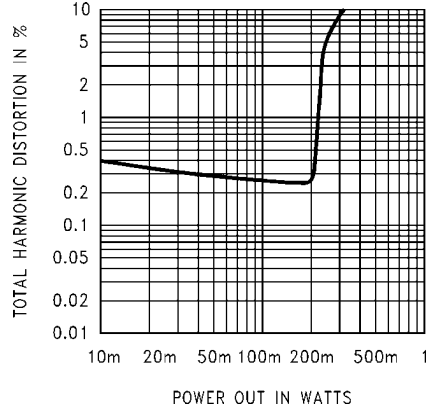

20035844

Power Supply Rejection Ratio (PSRR) at $V_{DD} = 5V$

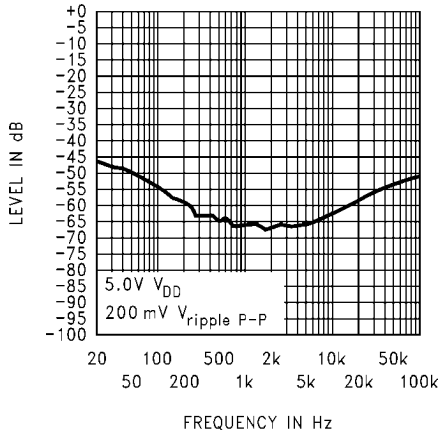

20035845

Input terminated with $10\Omega R$

Power Supply Rejection Ratio (PSRR) at $V_{DD} = 5V$

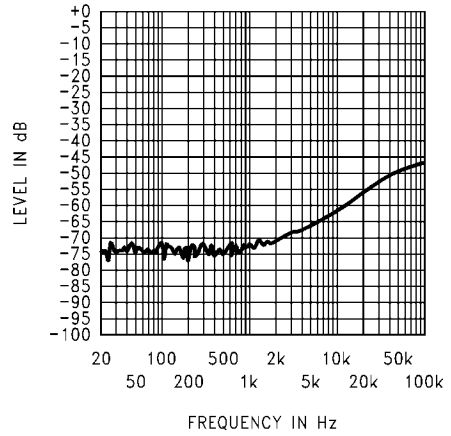

20035873

Input Floating

Power Supply Rejection Ratio (PSRR) at $V_{DD} = 2.6V$

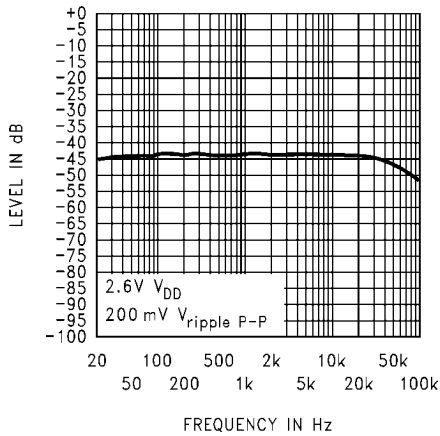

20035847

Input terminated with $10\Omega R$

Power Supply Rejection Ratio (PSRR) at $V_{DD} = 3.3V$

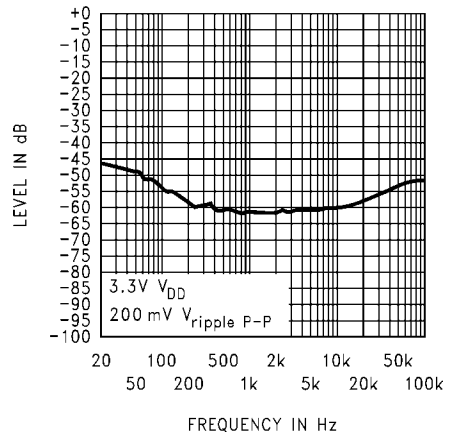

20035846

Input terminated with $10\Omega R$

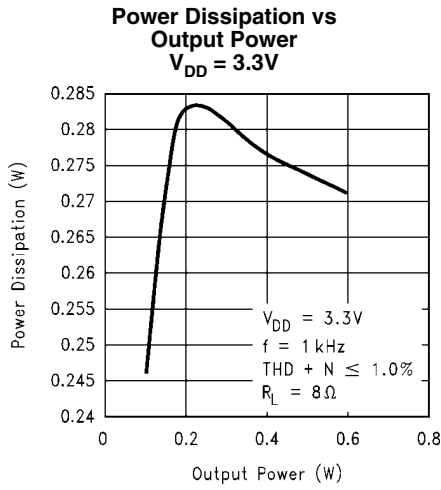

20035849

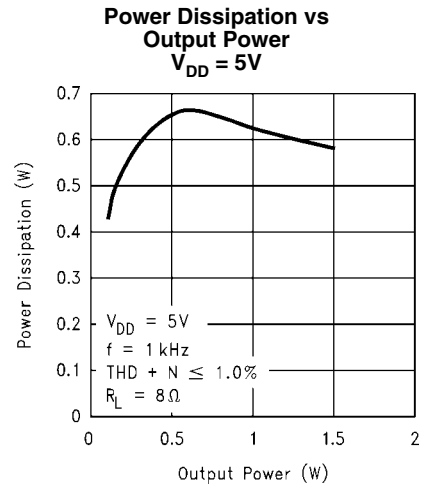

20035848

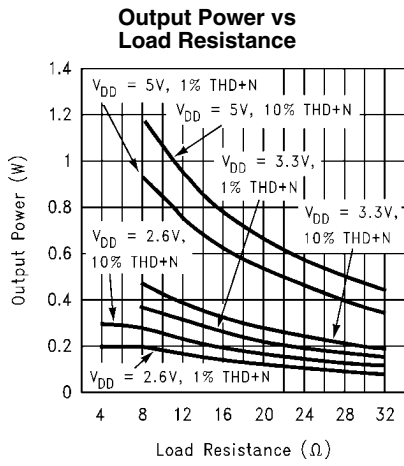

20035874

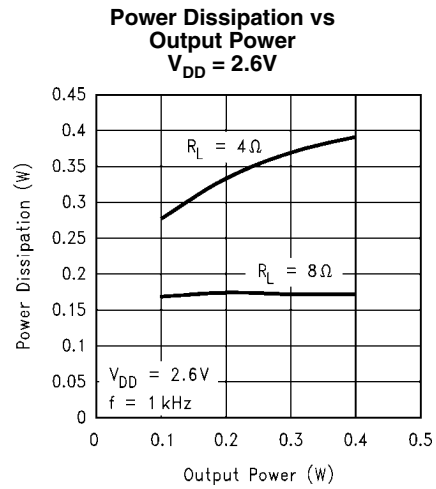

20035850

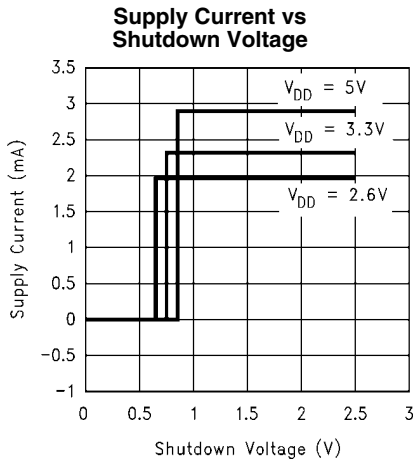

20035853

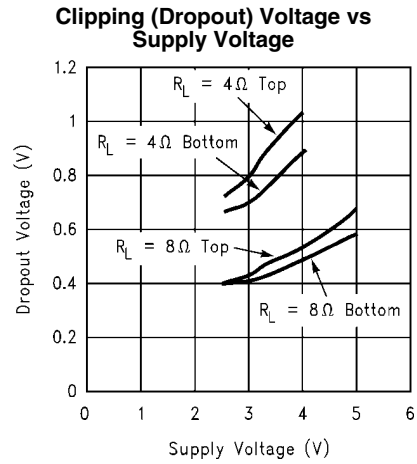

20035852

Open Loop Frequency Response

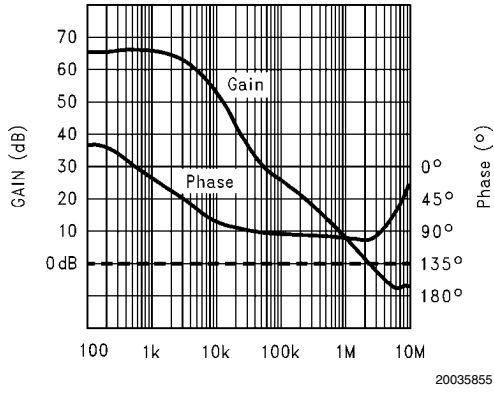

20035855

Frequency Response vs Input Capacitor Size

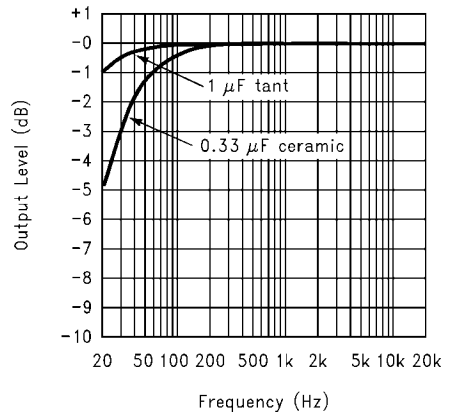

20035854

Noise Floor

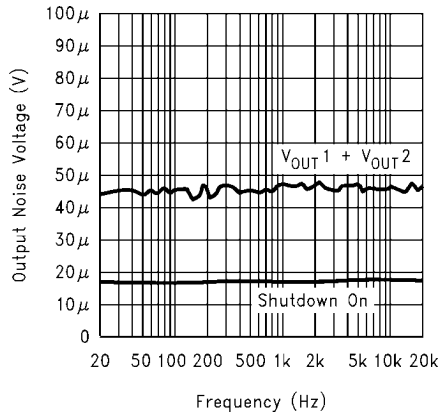

20035856

Power Derating Curves (P_{DMAX} = 670mW)

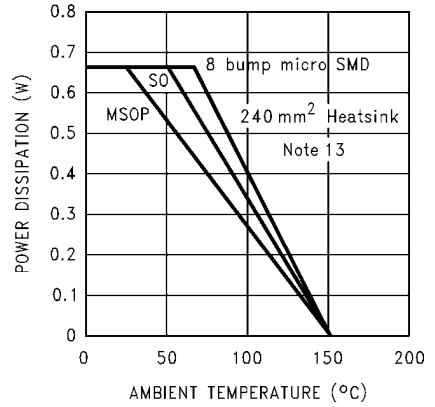

20035832

Power Derating Curves - 8 bump μSMD (P_{DMAX} = 670mW)

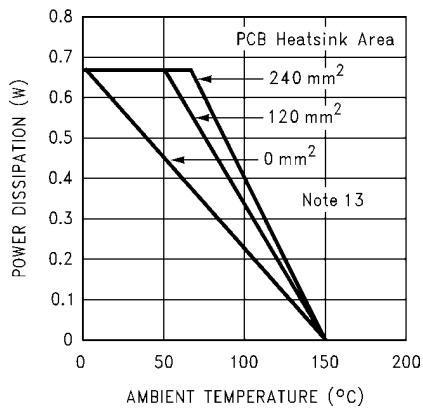

20035833

Power Derating Curves - 10 Pin LD pkg (P_{DMAX} = 670mW)

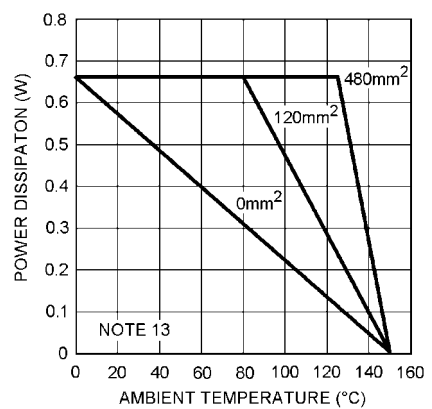

20035834

Application Information

BRIDGE CONFIGURATION EXPLANATION

As shown in *Figure 1*, the LM4889 has two operational amplifiers internally, allowing for a few different amplifier configurations. The first amplifier's gain is externally configurable, while the second amplifier is internally fixed in a unity-gain, inverting configuration. The closed-loop gain of the first amplifier is set by selecting the ratio of R_f to R_i while the second amplifier's gain is fixed by the two internal $20k\Omega$ resistors. *Figure 1* shows that the output of amplifier one serves as the input to amplifier two which results in both amplifiers producing signals identical in magnitude, but out of phase by 180° . Consequently, the differential gain for the IC is

$$A_{VD} = 2 * (R_f/R_i)$$

By driving the load differentially through outputs Vo1 and Vo2, an amplifier configuration commonly referred to as "bridged mode" is established. Bridged mode operation is different from the classical single-ended amplifier configuration where one side of the load is connected to ground.

A bridge amplifier design has an advantage over the single-ended configuration, as it provides differential drive to the load, thus doubling output swing for a specified supply voltage. Four times the output power is possible as compared to a single-ended amplifier under the same conditions. This increase in attainable output power assumes that the amplifier is not current limited or clipped. In order to choose an amplifier's closed-loop gain without causing excessive clipping, please refer to the **Audio Power Amplifier Design** section.

A bridge configuration, such as the one used in LM4889, also creates a second advantage over single-ended amplifiers. Since the differential outputs, Vo1 and Vo2, are biased at half-supply, no net DC voltage exists across the load. This eliminates the need for an output coupling capacitor which is required in a single supply, single-ended amplifier configuration. Without an output coupling capacitor, the half-supply bias across the load would result in both increased internal IC power dissipation and also possible loudspeaker damage.

POWER DISSIPATION

Power dissipation is a major concern when designing a successful amplifier, whether the amplifier is bridged or single-ended. A direct consequence of the increased power delivered to the load by a bridge amplifier is an increase in internal power dissipation. Since the LM4889 has two operational amplifiers in one package, the maximum internal power dissipation is 4 times that of a single-ended amplifier. The maximum power dissipation for a given application can be derived from the power dissipation graphs or from Equation 1.

$$P_{DMAX} = 4 * (V_{DD})^2 / (2\pi^2 R_L) \quad (1)$$

It is critical that the maximum junction temperature T_{JMAX} of 150°C is not exceeded. T_{JMAX} can be determined from the power derating curves by using P_{DMAX} and the PC board foil area. By adding additional copper foil, the thermal resistance of the application can be reduced from a free air value of 150°C/W , resulting in higher P_{DMAX} . Additional copper foil can be added to any of the leads connected to the LM4889. It is especially effective when connected to V_{DD} , G_{ND} , and the output pins. Refer to the application information on the LM4889 reference design board for an example of good heat sinking. If T_{JMAX} still exceeds 150°C , then additional changes must be made. These changes can include reduced supply voltage,

higher load impedance, or reduced ambient temperature. Internal power dissipation is a function of output power. Refer to the **Typical Performance Characteristics** curves for power dissipation information for different output powers and output loading.

POWER SUPPLY BYPASSING

As with any amplifier, proper supply bypassing is critical for low noise performance and high power supply rejection. The capacitor location on both the bypass and power supply pins should be as close to the device as possible. Typical applications employ a 5V regulator with $10\ \mu\text{F}$ tantalum or electrolytic capacitor and a ceramic bypass capacitor which aid in supply stability. This does not eliminate the need for bypassing the supply nodes of the LM4889. The selection of a bypass capacitor, especially C_B , is dependent upon PSRR requirements, click and pop performance (as explained in the section, **Proper Selection of External Components**), system cost, and size constraints.

SHUTDOWN FUNCTION

In order to reduce power consumption while not in use, the LM4889 contains a shutdown pin to externally turn off the amplifier's bias circuitry. This shutdown feature turns the amplifier off when a logic low is placed on the shutdown pin. By switching the shutdown pin to ground, the LM4889 supply current draw will be minimized in idle mode. While the device will be disabled with shutdown pin voltages less than $0.5V_{DC}$, the idle current may be greater than the typical value of $0.1\ \mu\text{A}$. (Idle current is measured with the shutdown pin grounded).

In many applications, a microcontroller or microprocessor output is used to control the shutdown circuitry to provide a quick, smooth transition into shutdown. Another solution is to use a single-pole, single-throw switch in conjunction with an external pull-up resistor. When the switch is closed, the shutdown pin is connected to ground and disables the amplifier. If the switch is open, then the external pull-up resistor will enable the LM4889. This scheme guarantees that the shutdown pin will not float thus preventing unwanted state changes.

PROPER SELECTION OF EXTERNAL COMPONENTS

Proper selection of external components in applications using integrated power amplifiers is critical to optimize device and system performance. While the LM4889 is tolerant of external component combinations, consideration to component values must be used to maximize overall system quality.

The LM4889 is unity-gain stable which gives the designer maximum system flexibility. The LM4889 should be used in low gain configurations to minimize THD+N values, and maximize the signal to noise ratio. Low gain configurations require large input signals to obtain a given output power. Input signals equal to or greater than $1\ \text{V}_{rms}$ are available from sources such as audio codecs. Please refer to the section, **Audio Power Amplifier Design**, for a more complete explanation of proper gain selection.

Besides gain, one of the major considerations is the closed-loop bandwidth of the amplifier. To a large extent, the bandwidth is dictated by the choice of external components shown in *Figure 1*. The input coupling capacitor, C_i , forms a first order high pass filter which limits low frequency response. This value should be chosen based on needed frequency response for a few reasons.

SELECTION OF INPUT CAPACITOR SIZE

Large input capacitors are both expensive and space hungry for portable designs. Clearly, a certain sized capacitor is

needed to couple in low frequencies without severe attenuation. But in many cases the speakers used in portable systems, whether internal or external, have little ability to reproduce signals below 100 Hz to 150 Hz. Thus, using a large input capacitor may not increase actual system performance.

In addition to system cost and size, click and pop performance is effected by the size of the input coupling capacitor, C_i . A larger input coupling capacitor requires more charge to reach its quiescent DC voltage (nominally $1/2 V_{DD}$). This charge comes from the output via the feedback and is apt to create pops upon device enable. Thus, by minimizing the capacitor size based on necessary low frequency response, turn-on pops can be minimized.

Besides minimizing the input capacitor size, careful consideration should be paid to the bypass capacitor value. Bypass capacitor, C_B , is the most critical component to minimize turn-on pops since it determines how fast the LM4889 turns on. The slower the LM4889's outputs ramp to their quiescent DC voltage (nominally $1/2 V_{DD}$), the smaller the turn-on pop. Choosing C_B equal to $1.0 \mu\text{F}$ along with a small value of C_i (in the range of $0.1 \mu\text{F}$ to $0.39 \mu\text{F}$), should produce a virtually clickless and popless shutdown function. While the device will function properly, (no oscillations or motorboating), with C_B equal to $0.1 \mu\text{F}$, the device will be much more susceptible to turn-on clicks and pops. Thus, a value of C_B equal to $1.0 \mu\text{F}$ is recommended in all but the most cost sensitive designs.

AUDIO POWER AMPLIFIER DESIGN

A 1W/8Ω Audio Amplifier

Given:

Power Output	1 Wrms
Load Impedance	8Ω
Input Level	1 Vrms
Input Impedance	20 kΩ
Bandwidth	100 Hz–20 kHz ± 0.25 dB

A designer must first determine the minimum supply rail to obtain the specified output power. By extrapolating from the Output Power vs Supply Voltage graphs in the **Typical Performance Characteristics** section, the supply rail can be easily found. A second way to determine the minimum supply rail is to calculate the required V_{opeak} using Equation 2 and add the output voltage. Using this method, the minimum supply voltage would be $(V_{\text{opeak}} + (V_{\text{ODTOP}} + V_{\text{ODBOT}}))$, where V_{ODBOT} and V_{ODTOP} are extrapolated from the Dropout Voltage vs Supply Voltage curve in the **Typical Performance Characteristics** section.

$$V_{\text{opeak}} = \sqrt{(2R_L P_O)}$$

(2)

5V is a standard voltage in most applications, it is chosen for the supply rail. Extra supply voltage creates headroom that allows the LM4889 to reproduce peaks in excess of 1W without producing audible distortion. At this time, the designer must make sure that the power supply choice along with the output impedance does not violate the conditions explained in the **Power Dissipation** section.

Once the power dissipation equations have been addressed, the required differential gain can be determined from Equation 3.

$$A_{VD} \geq \sqrt{(P_O R_L)} / (V_{IN}) = V_{\text{orms}} / V_{\text{inrms}}$$

(3)

$$R_f / R_i = A_{VD} / 2$$

From Equation 3, the minimum A_{VD} is 2.83; use $A_{VD} = 3$.

Since the desired input impedance was $20 \text{ k}\Omega$, and with a A_{VD} impedance of 2, a ratio of 1.5:1 of R_f to R_i results in an allocation of $R_i = 20 \text{ k}\Omega$ and $R_f = 30 \text{ k}\Omega$. The final design step is to address the bandwidth requirements which must be stated as a pair of -3 dB frequency points. Five times away from a -3 dB point is 0.17 dB down from passband response which is better than the required $\pm 0.25 \text{ dB}$ specified.

$$f_L = 100 \text{ Hz} / 5 = 20 \text{ Hz}$$

$$f_H = 20 \text{ kHz} * 5 = 100 \text{ kHz}$$

As stated in the **External Components** section, R_i in conjunction with C_i create a highpass filter.

$$C_i \geq 1 / (2\pi * 20 \text{ k}\Omega * 20 \text{ Hz}) = 0.397 \mu\text{F}; \text{ use } 0.39 \mu\text{F}$$

The high frequency pole is determined by the product of the desired frequency pole, f_H , and the differential gain, A_{VD} . With a $A_{VD} = 3$ and $f_H = 100 \text{ kHz}$, the resulting GBWP = 300 kHz which is much smaller than the LM4889 GBWP of 2.5 MHz . This calculation shows that if a designer has a need to design an amplifier with a higher differential gain, the LM4889 can still be used without running into bandwidth limitations.

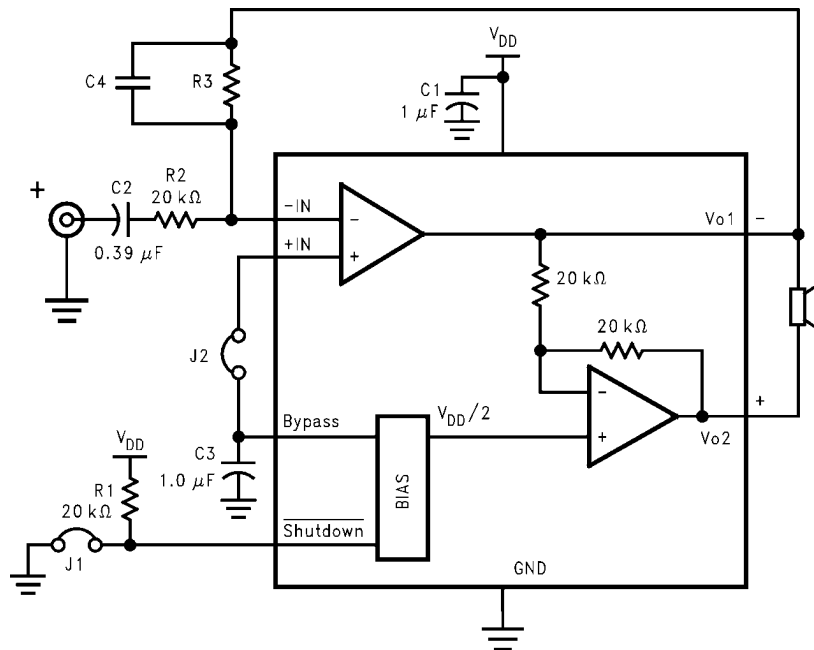

20035824

FIGURE 2. Higher Gain Audio Amplifier

The LM4889 is unity-gain stable and requires no external components besides gain-setting resistors, an input coupling capacitor, and proper supply bypassing in the typical application. However, if a closed-loop differential gain of greater than 10 is required, a feedback capacitor (C_4) may be needed as shown in Figure 2 to bandwidth limit the amplifier. This feedback capacitor creates a low pass filter that eliminates

possible high frequency oscillations. Care should be taken when calculating the -3dB frequency in that an incorrect combination of R_3 and C_4 will cause rolloff before 20kHz. A typical combination of feedback resistor and capacitor that will not produce audio band high frequency rolloff is $R_3 = 20\text{k}\Omega$ and $C_4 = 25\text{pf}$. These components result in a -3dB point of approximately 320kHz.

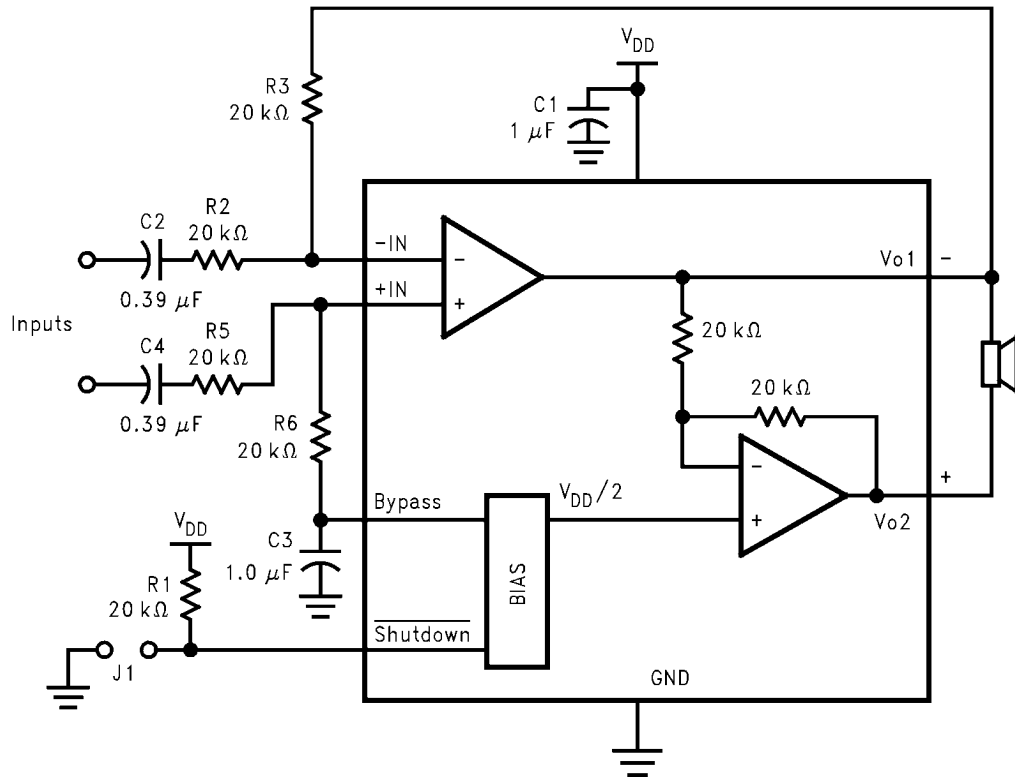

20035829

FIGURE 3. Differential Amplifier Configuration for LM4889

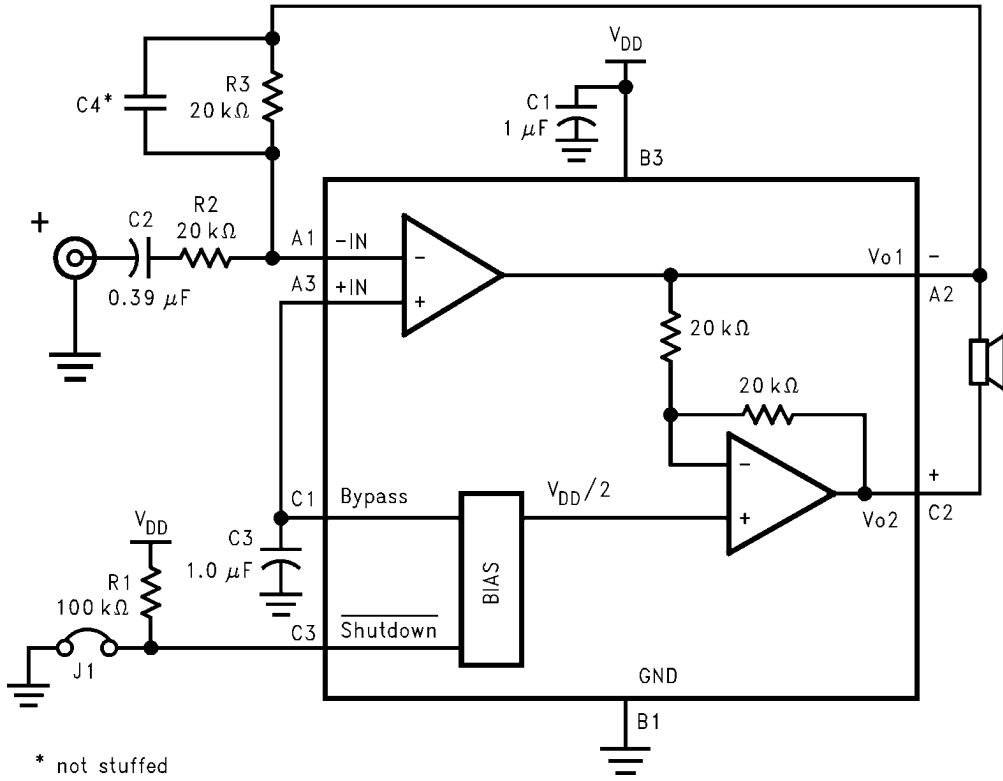
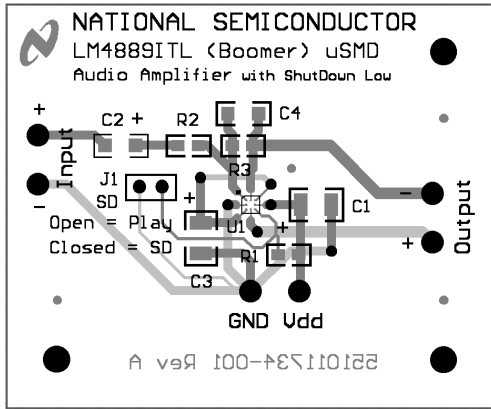

FIGURE 4. Reference Design Board and Layout - micro SMD

LM4889 micro SMD DEMO BOARD ARTWORK

Composite View



20035886

Silk Screen

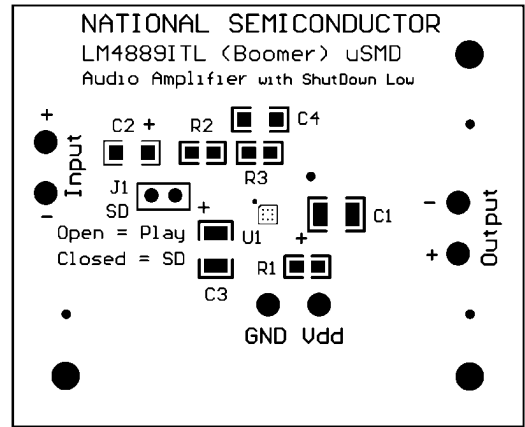

20035881

Top Layer

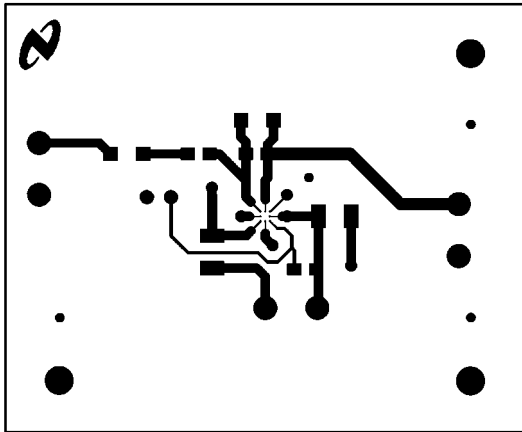

20035882

Bottom Layer

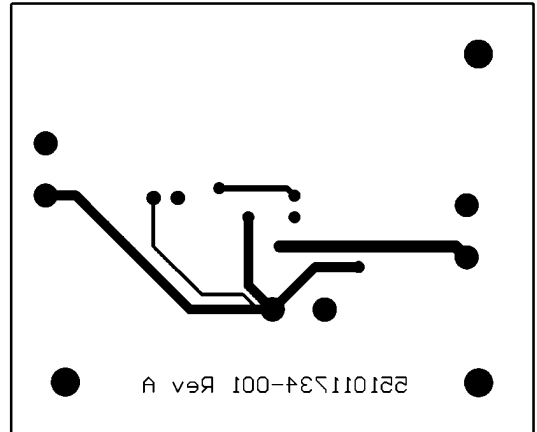

20035883

Inner Layer Ground

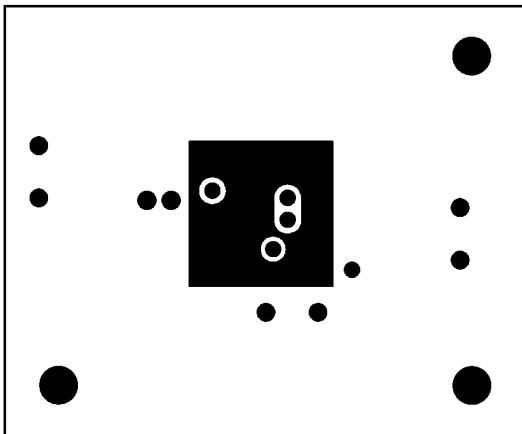

20035885

Inner Layer V_{DD}

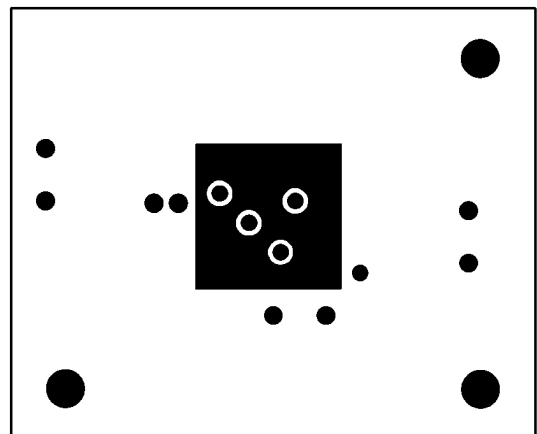

20035884

REFERENCE DESIGN BOARD AND PCB LAYOUT
GUIDELINES - MSOP & SO BOARDS

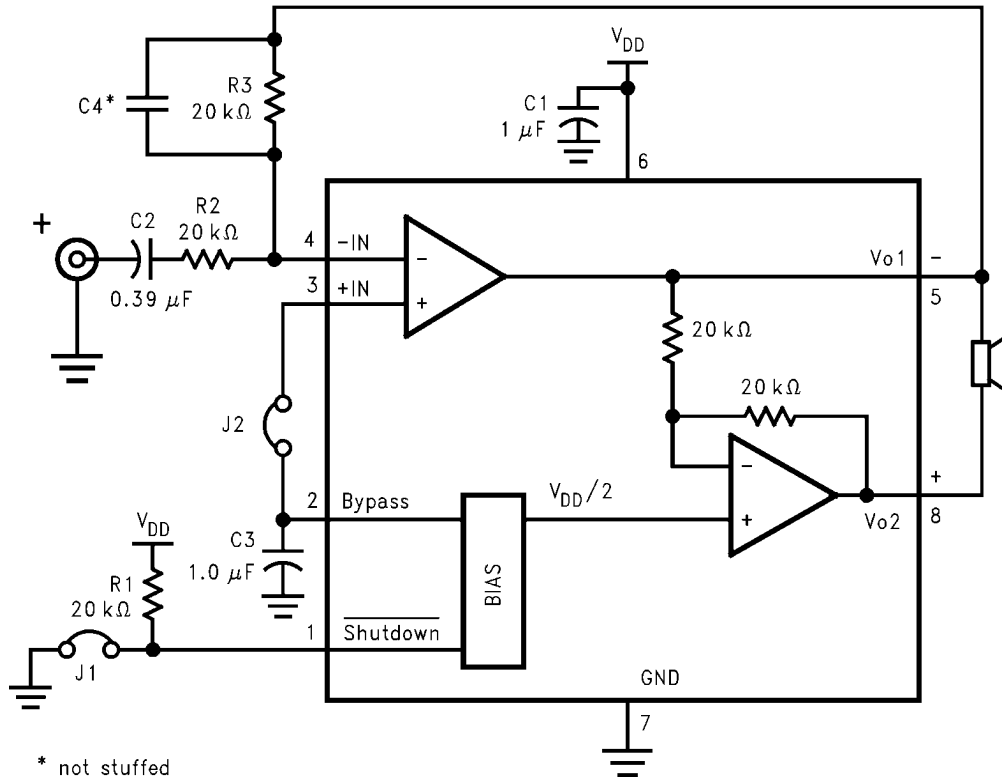
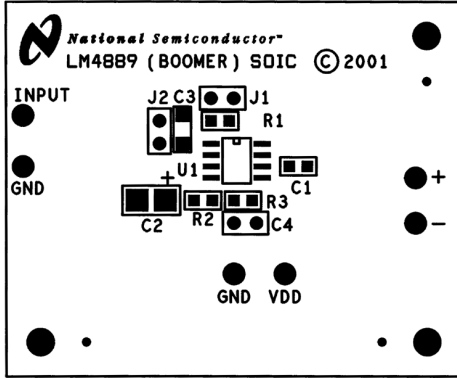

FIGURE 5. Reference Design Board

LM4889 SO DEMO BOARD ARTWORK

Silk Screen



Top Layer

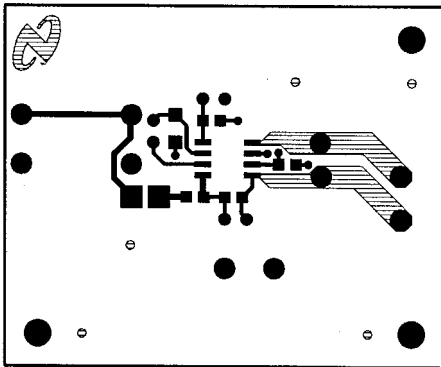

Bottom Layer

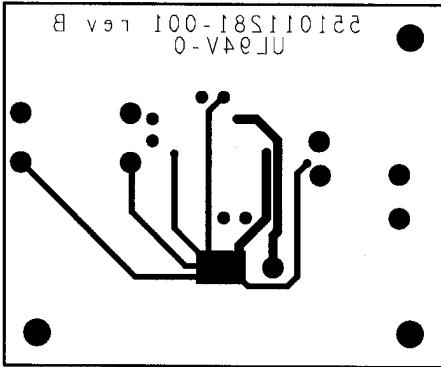

LM4889 MSOP DEMO BOARD ARTWORK

Silk Screen

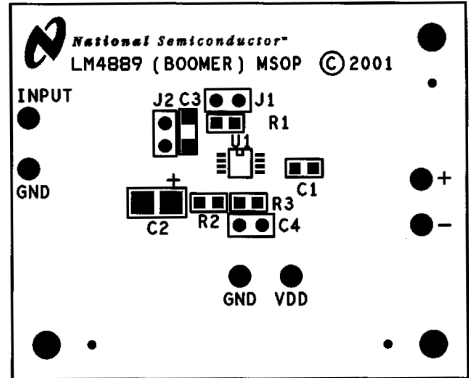

Top Layer

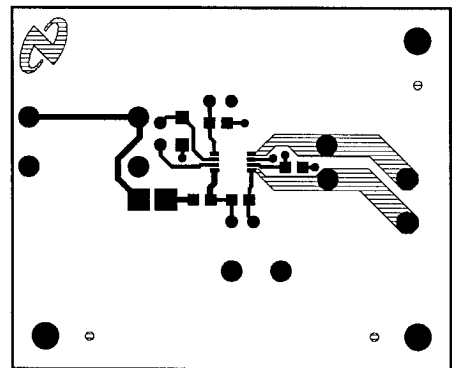

Bottom Layer

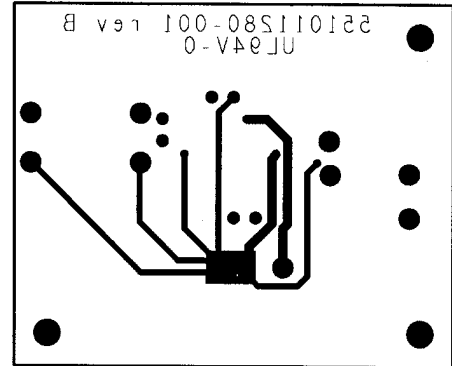

Physical Dimensions inches (millimeters) unless otherwise noted

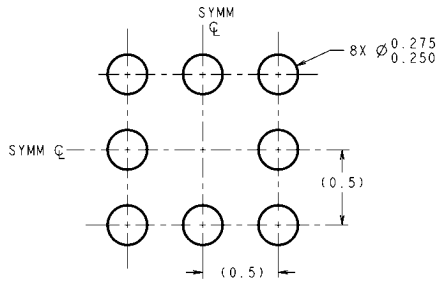

DIMENSIONS ARE IN MILLIMETERS
DIMENSIONS IN () FOR REFERENCE ONLY

LAND PATTERN RECOMMENDATION

TOP SIDE COATING

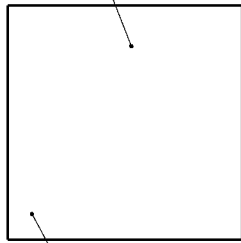

BUMP A1 CORNER

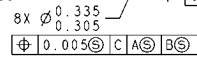
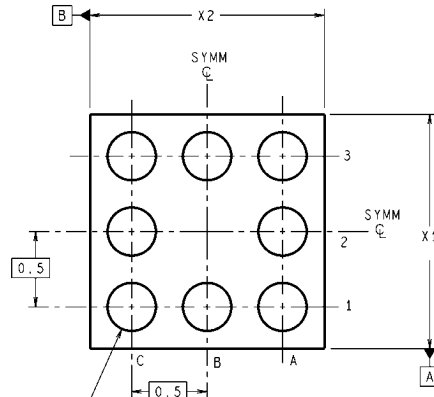
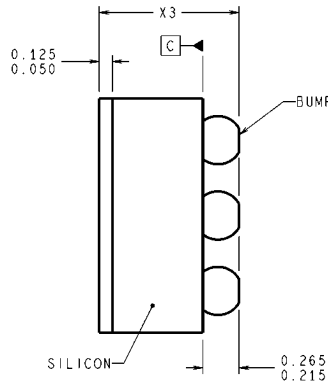

TLA08XXX (Rev C)

8-Bump micro SMD
Order Number LM4889ITL, LM4889ITLX
NS Package Number TLA08AAA
X1 = 1.514±0.03 X2 = 1.514±0.03 X3 = 0.600±0.075

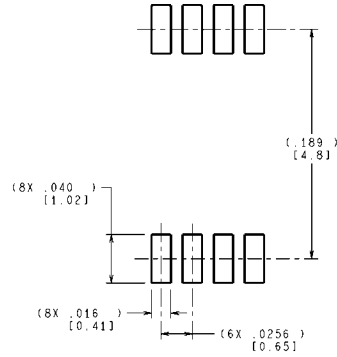
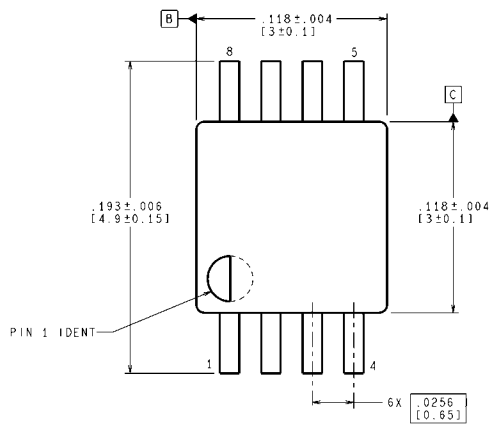

LAND PATTERN RECOMMENDATION

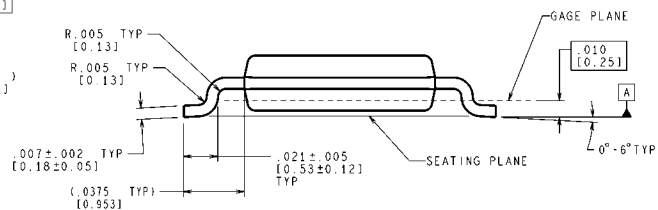
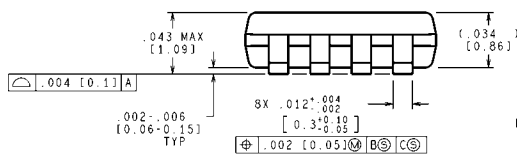

CONTROLLING DIMENSION IS INCH
VALUES IN [] ARE MILLIMETERS

MUA08A (Rev E)

MSOP
Order Number LM4889MM
NS Package Number MUA08A

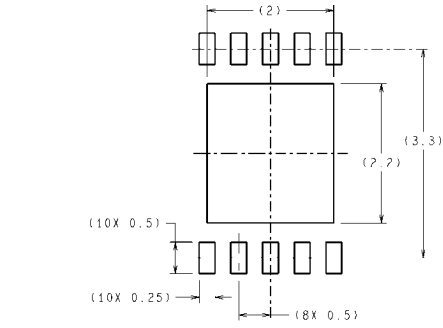

DIMENSIONS ARE IN MILLIMETERS
DIMENSIONS IN () FOR REFERENCE ONLY

RECOMMENDED LAND PATTERN
1:1 RATIO WITH PKG SOLDER PADS

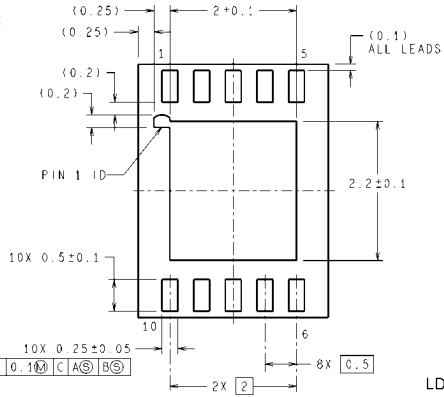
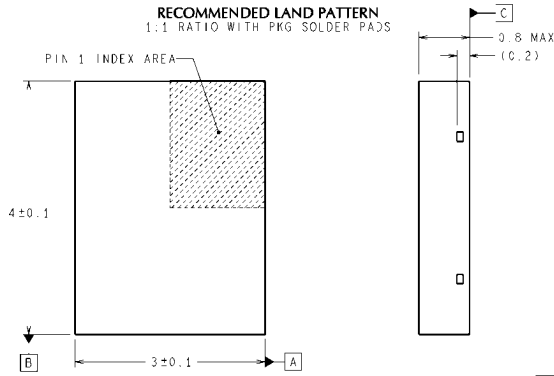

LDA10B (Rev B)

LLP
Order Number LM4889LD
NS Package Number LDA10B

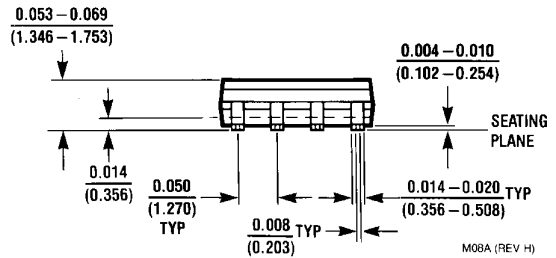
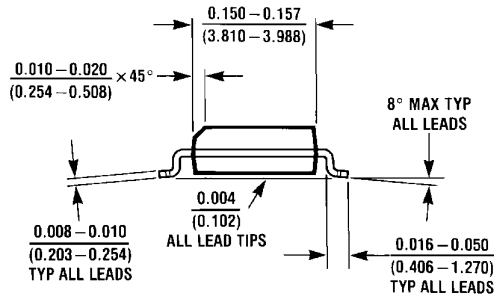
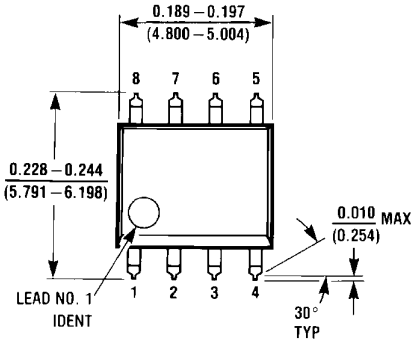

M08A (REV H)

SO
Order Number LM4889MA
NS Package Number M08A

Notes

LM4889

Notes

THE CONTENTS OF THIS DOCUMENT ARE PROVIDED IN CONNECTION WITH NATIONAL SEMICONDUCTOR CORPORATION ("NATIONAL") PRODUCTS. NATIONAL MAKES NO REPRESENTATIONS OR WARRANTIES WITH RESPECT TO THE ACCURACY OR COMPLETENESS OF THE CONTENTS OF THIS PUBLICATION AND RESERVES THE RIGHT TO MAKE CHANGES TO SPECIFICATIONS AND PRODUCT DESCRIPTIONS AT ANY TIME WITHOUT NOTICE. NO LICENSE, WHETHER EXPRESS, IMPLIED, ARISING BY ESTOPPEL OR OTHERWISE, TO ANY INTELLECTUAL PROPERTY RIGHTS IS GRANTED BY THIS DOCUMENT.

TESTING AND OTHER QUALITY CONTROLS ARE USED TO THE EXTENT NATIONAL DEEMS NECESSARY TO SUPPORT NATIONAL'S PRODUCT WARRANTY. EXCEPT WHERE MANDATED BY GOVERNMENT REQUIREMENTS, TESTING OF ALL PARAMETERS OF EACH PRODUCT IS NOT NECESSARILY PERFORMED. NATIONAL ASSUMES NO LIABILITY FOR APPLICATIONS ASSISTANCE OR BUYER PRODUCT DESIGN. BUYERS ARE RESPONSIBLE FOR THEIR PRODUCTS AND APPLICATIONS USING NATIONAL COMPONENTS. PRIOR TO USING OR DISTRIBUTING ANY PRODUCTS THAT INCLUDE NATIONAL COMPONENTS, BUYERS SHOULD PROVIDE ADEQUATE DESIGN, TESTING AND OPERATING SAFEGUARDS.

EXCEPT AS PROVIDED IN NATIONAL'S TERMS AND CONDITIONS OF SALE FOR SUCH PRODUCTS, NATIONAL ASSUMES NO LIABILITY WHATSOEVER, AND NATIONAL DISCLAIMS ANY EXPRESS OR IMPLIED WARRANTY RELATING TO THE SALE AND/OR USE OF NATIONAL PRODUCTS INCLUDING LIABILITY OR WARRANTIES RELATING TO FITNESS FOR A PARTICULAR PURPOSE, MERCHANTABILITY, OR INFRINGEMENT OF ANY PATENT, COPYRIGHT OR OTHER INTELLECTUAL PROPERTY RIGHT.

LIFE SUPPORT POLICY

NATIONAL'S PRODUCTS ARE NOT AUTHORIZED FOR USE AS CRITICAL COMPONENTS IN LIFE SUPPORT DEVICES OR SYSTEMS WITHOUT THE EXPRESS PRIOR WRITTEN APPROVAL OF THE CHIEF EXECUTIVE OFFICER AND GENERAL COUNSEL OF NATIONAL SEMICONDUCTOR CORPORATION. As used herein:

Life support devices or systems are devices which (a) are intended for surgical implant into the body, or (b) support or sustain life and whose failure to perform when properly used in accordance with instructions for use provided in the labeling can be reasonably expected to result in a significant injury to the user. A critical component is any component in a life support device or system whose failure to perform can be reasonably expected to cause the failure of the life support device or system or to affect its safety or effectiveness.

National Semiconductor and the National Semiconductor logo are registered trademarks of National Semiconductor Corporation. All other brand or product names may be trademarks or registered trademarks of their respective holders.

Copyright© 2006 National Semiconductor Corporation

For the most current product information visit us at www.national.com



**National Semiconductor
Americas Customer
Support Center**
Email:
new.feedback@nsc.com
Tel: 1-800-272-9959

**National Semiconductor Europe
Customer Support Center**
Fax: +49 (0) 180-530-85-86
Email: europe.support@nsc.com
Deutsch Tel: +49 (0) 69 9508 6208
English Tel: +49 (0) 870 24 0 2171
Français Tel: +33 (0) 1 41 91 8790

**National Semiconductor Asia
Pacific Customer Support Center**
Email: ap.support@nsc.com

**National Semiconductor Japan
Customer Support Center**
Fax: 81-3-5639-7507
Email: jpn.feedback@nsc.com
Tel: 81-3-5639-7560