

FFP04U40DN

Features

- Ultrafast with soft recovery
- Low forward voltage

Applications

- Power switching circuits
- Output rectifiers
- Freewheeling diodes
- Switching mode power supply

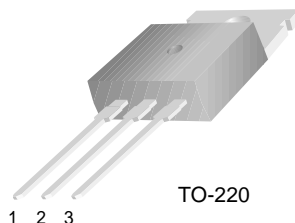

TO-220

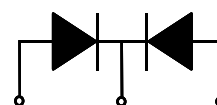

1. Anode 2. Cathode 3. Anode

ULTRA FAST RECOVERY POWER RECTIFIER

Absolute Maximum Ratings (per diode) $T_C=25^\circ\text{C}$ unless otherwise noted

Symbol	Parameter	Value	Units
V_{RRM}	Peak Repetitive Reverse Voltage	400	V
$I_{F(AV)}$	Average Rectified Forward Current @ $T_C = 100^\circ\text{C}$	4	A
I_{FSM}	Non-repetitive Peak Surge Current 60Hz Single Half-Sine Wave	40	A
T_J, T_{STG}	Operating Junction and Storage Temperature	- 65 to +150	$^\circ\text{C}$

Thermal Characteristics

Symbol	Parameter	Value	Units
$R_{\theta JC}$	Maximum Thermal Resistance, Junction to Case	10	$^\circ\text{C}/\text{W}$

Electrical Characteristics (per diode) $T_C=25^\circ\text{C}$ unless otherwise noted

Symbol	Parameter	Min.	Typ.	Max.	Units	
V_{FM}^*	Maximum Instantaneous Forward Voltage $I_F = 4\text{A}$ $I_F = 4\text{A}$	$T_C = 25^\circ\text{C}$	-	-	1.4	V
		$T_C = 100^\circ\text{C}$	-	-	1.3	
I_{RM}^*	Maximum Instantaneous Reverse Current @ rated V_R	$T_C = 25^\circ\text{C}$	-	-	10	μA
		$T_C = 100^\circ\text{C}$	-	-	100	
t_{rr}	Maximum Reverse Recovery Time	-	-	45	ns	
I_{rr}	Maximum Reverse Recovery Current	-	-	3.0	A	
Q_{rr}	Maximum Reverse Recovery Charge ($I_F = 4\text{A}$, $di/dt = 200\text{A}/\mu\text{s}$)	-	-	68	nC	
W_{AVL}	Avalanche Energy	1.0	-	-	mJ	

* Pulse Test: Pulse Width=300 μs , Duty Cycle=2%

Typical Characteristics

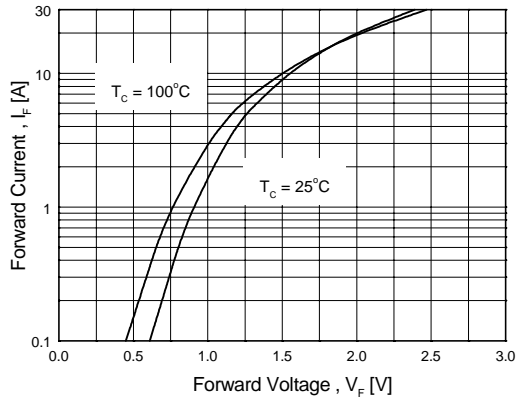

Figure 1. Typical Forward Voltage Drop vs. Forward Current

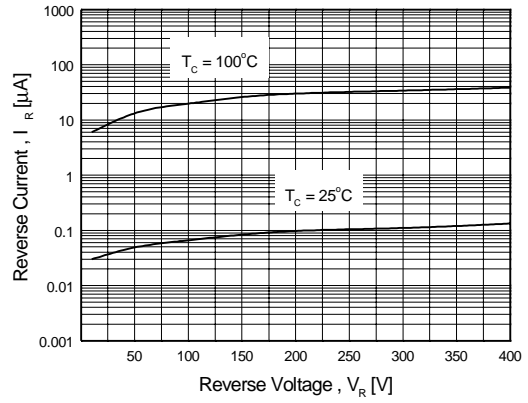

Figure 2. Typical Reverse Current vs. Reverse Voltage

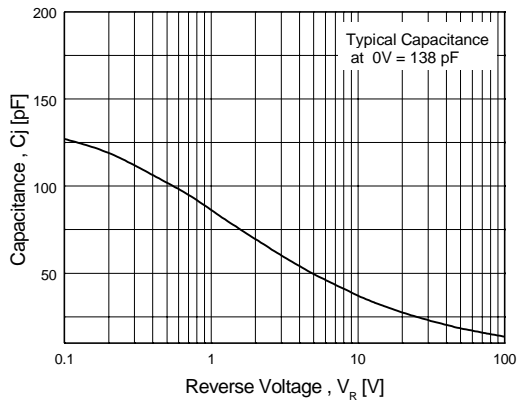

Figure 3. Typical Junction Capacitance

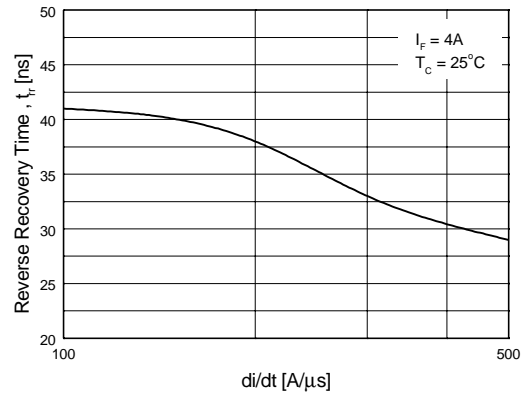

Figure 4. Typical Reverse Recovery Time vs. di/dt

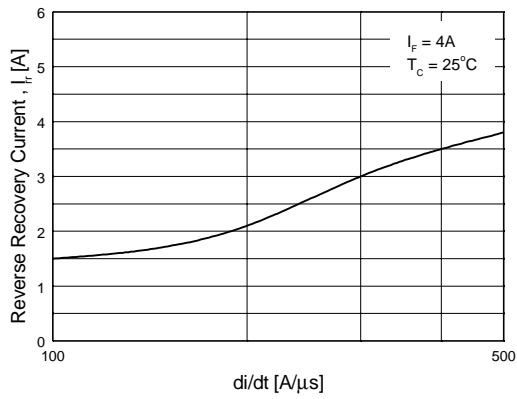

Figure 5. Typical Reverse Recovery Current vs. di/dt

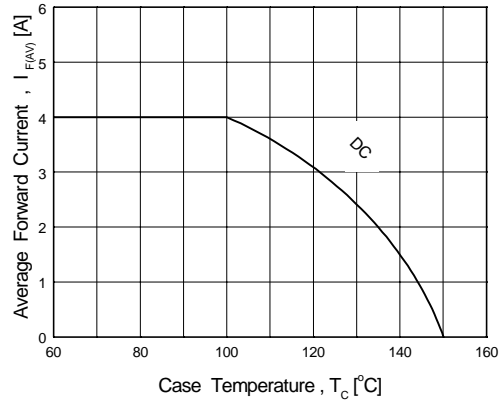
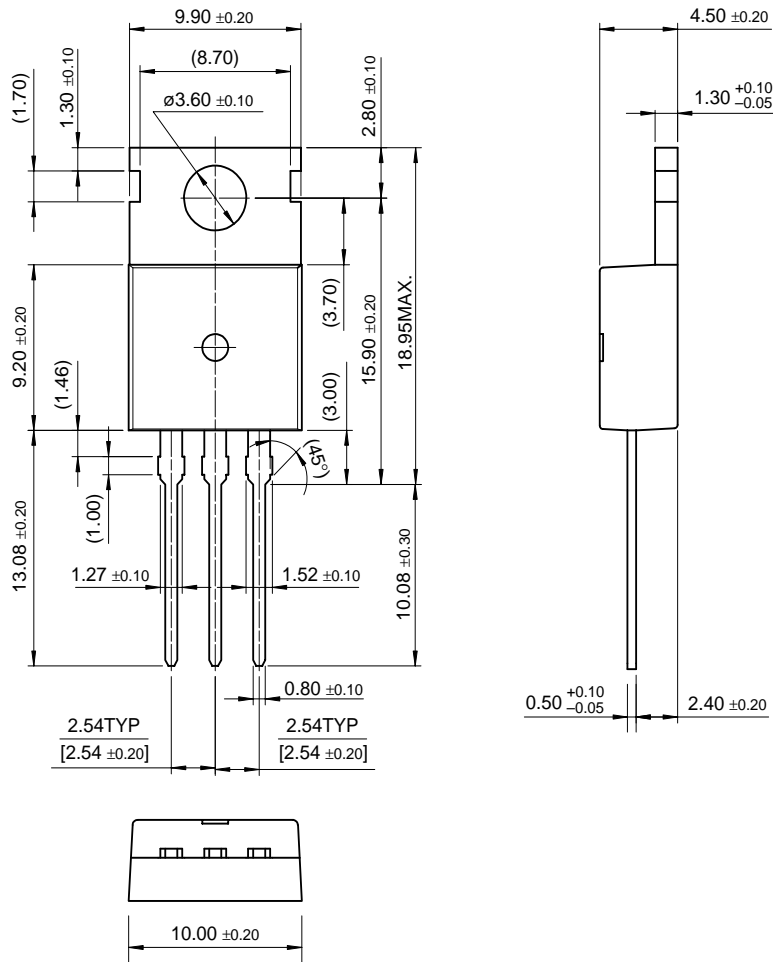

Figure 6. Forward Current Derating Curve

Package Dimensions

TO-220

FFP04U40DN



Dimensions in Millimeters

TRADEMARKS

The following are registered and unregistered trademarks Fairchild Semiconductor owns or is authorized to use and is not intended to be an exhaustive list of all such trademarks.

ACEx™	FASTr™	QFET™	VCX™
Bottomless™	GlobalOptoisolator™	QS™	
CoolFET™	GTO™	QT Optoelectronics™	
CROSSVOLT™	HiSeC™	Quiet Series™	
DOME™	ISOPANAR™	SuperSOT™-3	
E ² CMOS™	MICROWIRE™	SuperSOT™-6	
EnSigna™	OPTOLOGIC™	SuperSOT™-8	
FACT™	OPTOPLANAR™	SyncFET™	
FACT Quiet Series™	POP™	TinyLogic™	
FAST®	PowerTrench®	UHC™	

DISCLAIMER

FAIRCHILD SEMICONDUCTOR RESERVES THE RIGHT TO MAKE CHANGES WITHOUT FURTHER NOTICE TO ANY PRODUCTS HEREIN TO IMPROVE RELIABILITY, FUNCTION OR DESIGN. FAIRCHILD DOES NOT ASSUME ANY LIABILITY ARISING OUT OF THE APPLICATION OR USE OF ANY PRODUCT OR CIRCUIT DESCRIBED HEREIN; NEITHER DOES IT CONVEY ANY LICENSE UNDER ITS PATENT RIGHTS, NOR THE RIGHTS OF OTHERS.

LIFE SUPPORT POLICY

FAIRCHILD'S PRODUCTS ARE NOT AUTHORIZED FOR USE AS CRITICAL COMPONENTS IN LIFE SUPPORT DEVICES OR SYSTEMS WITHOUT THE EXPRESS WRITTEN APPROVAL OF FAIRCHILD SEMICONDUCTOR CORPORATION. As used herein:

1. Life support devices or systems are devices or systems which, (a) are intended for surgical implant into the body, or (b) support or sustain life, or (c) whose failure to perform when properly used in accordance with instructions for use provided in the labeling, can be reasonably expected to result in significant injury to the user.
2. A critical component is any component of a life support device or system whose failure to perform can be reasonably expected to cause the failure of the life support device or system, or to affect its safety or effectiveness.

PRODUCT STATUS DEFINITIONS

Definition of Terms

Datasheet Identification	Product Status	Definition
Advance Information	Formative or In Design	This datasheet contains the design specifications for product development. Specifications may change in any manner without notice.
Preliminary	First Production	This datasheet contains preliminary data, and supplementary data will be published at a later date. Fairchild Semiconductor reserves the right to make changes at any time without notice in order to improve design.
No Identification Needed	Full Production	This datasheet contains final specifications. Fairchild Semiconductor reserves the right to make changes at any time without notice in order to improve design.
Obsolete	Not In Production	This datasheet contains specifications on a product that has been discontinued by Fairchild semiconductor. The datasheet is printed for reference information only.

[find products](#)

[Home >> Find products >>](#)

[Products groups](#)

[Analog and Mixed](#)

[Signal](#)

[Discrete](#)

[Interface](#)

[Logic](#)

[Microcontrollers](#)

[Non-Volatile](#)

[Memory](#)

[Optoelectronics](#)

[Markets and](#)

[applications](#)

[New products](#)

[Product selection and](#)

[parametric search](#)

[Cross-reference](#)

[search](#)

FFP04U40DN
4.0A/400V Ultra Fast Recovery Rectifier

Contents

[Features](#) | [Applications](#) | [Product status/pricing/packaging](#)

Features

- Ultrafast with Soft Recovery
- Low Forward Voltage

[back to top](#)

Applications

- Power Switching Circuits
- Output rectifiers
- Freewheeling Diodes
- Switching Mode Power Supply

[back to top](#)

Product status/pricing/packaging

Product	Product status	Pricing*	Package type	Leads	Packing method
FFP04U40DNTU	Full Production	\$0.55	TO-220	3	RAIL

* 1,000 piece Budgetary Pricing

[back to top](#)

[Home](#) | [Find products](#) | [Technical information](#) | [Buy products](#) | [Support](#) | [Company](#) | [Contact us](#) | [Site index](#) | [Privacy policy](#)

Related Links

[Request samples](#)

[Dotted line](#)

[How to order products](#)

[Dotted line](#)

[Product Change Notices](#)

[\(PCNs\)](#)

[Dotted line](#)

[Support](#)

[Dotted line](#)

[Distributor and field sales](#)

[representatives](#)

[Dotted line](#)

[Quality and reliability](#)

[Dotted line](#)

[Design tools](#)

Datasheet

[Download this](#)

[datasheet](#)



[e-mail this datasheet](#)



This page [Print version](#)