

FEATURES

- Laser trimmed to high accuracy**
10.000 V \pm 5 mV (U grade)
- Trimmed temperature coefficient**
5 ppm/ $^{\circ}$ C maximum (U grade)
- Noise-reduction capability**
- Low quiescent current: 4 mA maximum**
- Output trim capability**
- MIL-STD-883-compliant versions available**

GENERAL DESCRIPTION

The AD587 represents a major advance in state-of-the-art monolithic voltage references. Using a proprietary ion-implanted buried Zener diode and laser wafer trimming of high stability thin-film resistors, the AD587 provides outstanding performance at low cost.

The AD587 offers much higher performance than most other 10 V references. Because the AD587 uses an industry-standard pinout, many systems can be upgraded instantly with the AD587.

The buried Zener approach to reference design provides lower noise and drift than band gap voltage references. The AD587 offers a noise-reduction pin that can be used to further reduce the noise level generated by the buried Zener.

The AD587 is recommended for use as a reference for 8-bit, 10-bit, 12-bit, 14-bit, or 16-bit DACs that require an external precision reference. The device is also ideal for successive approximation or integrating ADCs with up to 14 bits of accuracy. In general, it offers better performance than standard on-chip references.

The AD587J and AD587K are specified for operation from 0 $^{\circ}$ C to 70 $^{\circ}$ C, and the AD587U is specified for operation from -55 $^{\circ}$ C to +125 $^{\circ}$ C. The AD587JQ and AD587UQ models are available in 8-lead CERDIP. Other models are available in an 8-lead SOIC package for surface-mount applications, or in an 8-lead PDIP.

FUNCTIONAL BLOCK DIAGRAM



NOTE
PIN 1, PIN 3, AND PIN 7 ARE INTERNAL TEST POINTS. NO CONNECTIONS TO THESE POINTS.

00630-001

Figure 1.

PRODUCT HIGHLIGHTS

1. Laser trimming of both initial accuracy and temperature coefficients. This laser trimming results in very low errors over temperature without the use of external components. The AD587U guarantees \pm 14 mV maximum total error between -55 $^{\circ}$ C and +125 $^{\circ}$ C.
2. Optional fine trim connection. This connection is designed for applications requiring higher precision.
3. Instant upgrade of any system using an industry-standard pinout 10 V reference.
4. Very low output noise. AD587 output noise is typically 4 μ V p-p. A noise-reduction pin is provided for additional noise filtering using an external capacitor.
5. MIL-STD-883-compliant versions available. Refer to the Analog Devices *Military/Aerospace Reference Manual* for detailed specifications.

Rev. H

Information furnished by Analog Devices is believed to be accurate and reliable. However, no responsibility is assumed by Analog Devices for its use, nor for any infringements of patents or other rights of third parties that may result from its use. Specifications subject to change without notice. No license is granted by implication or otherwise under any patent or patent rights of Analog Devices. Trademarks and registered trademarks are the property of their respective owners.

TABLE OF CONTENTS

Features	1	Noise Performance and Reduction	6
Functional Block Diagram	1	Turn-On Time	7
General Description	1	Dynamic Performance.....	7
Product Highlights	1	Load Regulation	8
Revision History	2	Temperature Performance.....	8
Specifications.....	3	Negative Reference Voltage from an AD587	9
Absolute Maximum Ratings.....	4	Applications Information	10
ESD Caution.....	4	Using the AD587 with Converters.....	10
Pin Configuration and Function Descriptions.....	5	Outline Dimensions	11
Theory of Operation	6	Ordering Guide	12
Applying the AD587	6		

REVISION HISTORY

9/07—Rev. G to Rev. H

Deleted AD587L Grade	Universal
Change to Product Highlights	1
Changes to the Negative Reference Voltage from an AD587 Section	9
Changes to Figure 19.....	10
Changes to Figure 21 and Figure 22.....	10
Updated Outline Dimensions	11
Changes to Ordering Guide	12

4/05—Rev. F to Rev. G

Updated Format	Universal
Added Table 3.....	5
Updated Outline Dimensions	11
Changes to Ordering Guide	13

7/04—Rev. E to Rev. F

Changes to Ordering Guide	3
---------------------------------	---

7/03—Rev. D to Rev. E.

Deletion of S and T Grades	Universal
Edits to Ordering Guide	2
Deletion of Die Specifications	3
Edits to Figure 3.....	4
Updated Outline Dimensions	9

SPECIFICATIONS

$T_A = 25^\circ\text{C}$, $V_{IN} = 15\text{ V}$, unless otherwise noted.

Table 1.

Parameter	AD587J			AD587K			AD587U			Unit
	Min	Typ	Max	Min	Typ	Max	Min	Typ	Max	
OUTPUT VOLTAGE	9.990		10.010	9.995		10.005	9.995		10.005	V
OUTPUT VOLTAGE DRIFT ¹										
0°C to 70°C			20			10			5	ppm/ $^\circ\text{C}$
-55°C to $+125^\circ\text{C}$			20			10			5	ppm/ $^\circ\text{C}$
GAIN ADJUSTMENT	+3			+3			+3			%
	-1			-1			-1			%
LINE REGULATION ¹										
$13.5\text{ V} \leq V_{IN} \leq 36\text{ V}$										
T_{MIN} to T_{MAX}			± 100			± 100			± 100	$\mu\text{V}/\text{V}$
LOAD REGULATION ¹										
Sourcing $0\text{ mA} < I_{OUT} < 10\text{ mA}$										
T_{MIN} to T_{MAX}			± 100			± 100			± 100	$\mu\text{V}/\text{mA}$
Sourcing $-10\text{ mA} < I_{OUT} < 0\text{ mA}$ ²										
T_{MIN} to T_{MAX}			± 100			± 100			± 100	$\mu\text{V}/\text{mA}$
QUIESCENT CURRENT		2	4		2	4		2	4	mA
POWER DISSIPATION		30			30			30		mW
OUTPUT NOISE										
0.1 Hz to 10 Hz		4			4			4		μV p-p
Spectral Density, 100 Hz		100			100			100		$\text{nV}/\sqrt{\text{Hz}}$
LONG-TERM STABILITY		± 15			± 15			± 15		ppm/1000 hr
SHORT-CIRCUIT CURRENT-TO-GROUND		30	70		30	70		30	70	mA
SHORT-CIRCUIT CURRENT-TO- $+V_{IN}$		30	70		30	70		30	70	mA
TEMPERATURE RANGE										
Specified Performance (J, K)	0		70	0		70	0		70	$^\circ\text{C}$
Operating Performance (J, K) ³	-40		+85	-40		+85	-40		+85	$^\circ\text{C}$
Specified Performance (U)	-55		+125	-55		+125	-55		+125	$^\circ\text{C}$
Operating Performance (U) ³	-55		+125	-55		+125	-55		+125	$^\circ\text{C}$

¹ Specification is guaranteed for all packages and grades. CERDIP-packaged parts are 100% production tested.

² Load regulation (sinking) specification for SOIC (R-8) package is $\pm 200\ \mu\text{V}/\text{mA}$.

³ The operating temperature range is defined as the temperature extremes at which the device will still function. Parts may deviate from their specified performance outside their specified temperature range.

ABSOLUTE MAXIMUM RATINGS

Table 2.

Parameter	Rating
+V _{IN} to Ground	36 V
Power Dissipation (25°C)	500 mW
Storage Temperature Range	–65°C to +150°C
Lead Temperature (Soldering, 10 sec)	300°C
Package Thermal Resistance	
θ _{JC}	22°C/W
θ _{JA}	110°C/W
Output Protection	
Short to Ground	Indefinite ¹
Short to +V _{IN}	Momentary ¹

¹ Period for which output is safe.

Stresses above those listed under Absolute Maximum Ratings may cause permanent damage to the device. This is a stress rating only; functional operation of the device at these or any other conditions above those indicated in the operational section of this specification is not implied. Exposure to absolute maximum rating conditions for extended periods may affect device reliability.

ESD CAUTION



ESD (electrostatic discharge) sensitive device. Charged devices and circuit boards can discharge without detection. Although this product features patented or proprietary protection circuitry, damage may occur on devices subjected to high energy ESD. Therefore, proper ESD precautions should be taken to avoid performance degradation or loss of functionality.

PIN CONFIGURATION AND FUNCTION DESCRIPTIONS



*TP DENOTES FACTORY TEST POINT.
NO CONNECTIONS SHOULD BE MADE
TO THESE PINS.

00530-002

Figure 2. Pin Configuration

Table 3. Pin Function Descriptions

Pin No.	Mnemonic	Description
1, 3, 7	TP	No Connection. Leave floating.
2	+V _{IN}	Input Voltage.
4	GND	Ground.
5	TRIM	Fine Trimming of Output Voltage. See Figure 4.
6	V _{OUT}	Output Voltage.
8	NOISE REDUCTION	Noise Reduction of Output Voltage. Reduces noise via external capacitor to ground.

THEORY OF OPERATION

The AD587 consists of a proprietary buried Zener diode reference, an amplifier to buffer the output, and several high stability thin-film resistors, as shown in Figure 3. This design results in a high precision monolithic 10 V output reference with initial offset of 5 mV or less. The temperature-compensation circuitry provides the device with a temperature coefficient of less than 5 ppm/°C.

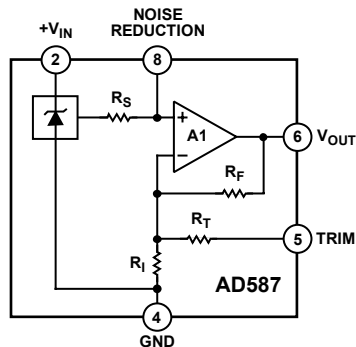

NOTE
PIN 1, PIN 3, AND PIN 7 ARE INTERNAL TEST POINTS. NO CONNECTIONS TO THESE POINTS.

Figure 3. Functional Block Diagram

A capacitor can be added at the NOISE REDUCTION pin (Pin 8) to form a low-pass filter with R_S to reduce the noise contribution of the Zener to the circuit.

APPLYING THE AD587

The AD587 is simple to use in virtually all precision reference applications. When power is applied to Pin 2 and Pin 4 is grounded, Pin 6 provides a 10 V output. No external components are required; the degree of desired absolute accuracy is achieved simply by selecting the required device grade. The AD587 requires less than 4 mA quiescent current from an operating supply of 15 V.

Fine trimming may be desired to set the output level to exactly 10.000 V (calibrated to a main system reference). System calibration may also require a reference voltage that is slightly different from 10.000 V, for example, 10.24 V for binary applications. In either case, the optional fine-trimming circuit shown in Figure 4 can offset the output by as much as 300 mV with minimal effect on other device characteristics.



Figure 4. Optional Fine-Trimming Configuration

NOISE PERFORMANCE AND REDUCTION

Noise generated by the AD587 is typically less than 4 μV p-p over the 0.1 Hz to 10 Hz band. Noise in a 1 MHz bandwidth is approximately 200 μV p-p. The dominant source of this noise is the buried Zener, contributing approximately 100 nV/ $\sqrt{\text{Hz}}$. By comparison, the contribution of the op amp is negligible. Figure 5 shows the 0.1 Hz to 10 Hz noise of a typical AD587. The noise measurement is made with a band-pass filter made of a 1-pole high-pass filter with a corner frequency at 0.1 Hz and a 2-pole low-pass filter with a corner frequency at 12.6 Hz to create a filter with a 9.922 Hz bandwidth.

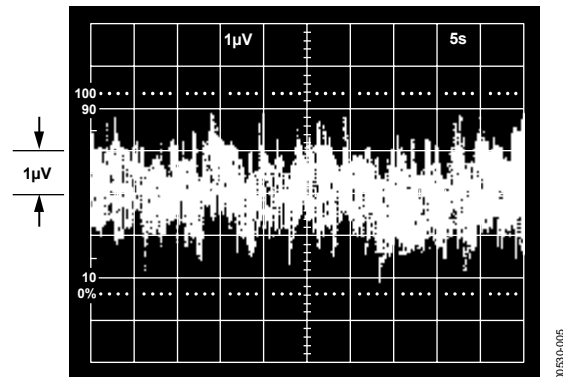

Figure 5. 0.1 Hz to 10 Hz Noise

If further noise reduction is desired, an external capacitor can be added between the NOISE REDUCTION pin and ground, as shown in Figure 4. This capacitor, combined with the 4 k Ω R_S and the Zener resistances, forms a low-pass filter on the output of the Zener cell. A 1 μF capacitor has a 3 dB point at 40 Hz and reduces the high frequency (up to 1 MHz) noise to about 160 μV p-p. Figure 6 shows the 1 MHz noise of a typical AD587, both with and without a 1 μF capacitor.



Figure 6. Effect of 1 μF Noise-Reduction Capacitor on Broadband Noise

TURN-ON TIME

Upon application of power (cold start), the time required for the output voltage to reach its final value within a specified error band is defined as the turn-on settling time. Two components normally associated with this are the time for the active circuits to settle and the time for the thermal gradients on the chip to stabilize. Figure 7, Figure 8, and Figure 9 show the turn-on characteristics of the AD587. These figures show the settling to be about 60 μ s to 0.01%. Note the absence of any thermal tails when the horizontal scale is expanded to 1 ms/cm in Figure 8.

Output turn-on time is modified when an external noise reduction capacitor is used. When present, this capacitor acts as an additional load to the current source of the internal Zener diode, resulting in a somewhat longer turn-on time. In the case of a 1 μ F capacitor, the initial turn-on time is approximately 400 ms to 0.01%, as shown in Figure 9.



Figure 7. Electrical Turn-On



Figure 8. Extended Time Scale



Figure 9. Turn-On with 1 μ F C_N

DYNAMIC PERFORMANCE

The output buffer amplifier is designed to provide the AD587 with static and dynamic load regulation that is superior to less complete references.

Many ADCs and DACs present transient current loads to the reference, and poor reference response can degrade the converter's performance.

Figure 11 and Figure 12 display the characteristics of the AD587 output amplifier driving a 0 mA to 10 mA load.



Figure 10. Transient Load Test Circuit



Figure 11. Large-Scale Transient Response



Figure 12. Fine-Scale Setting for Transient Load

In some applications, a varying load may be both resistive and capacitive in nature, or the load may be connected to the AD587 by a long capacitive cable.

Figure 14 displays the output amplifier characteristics driving a 1000 pF, 0 mA to 10 mA load.



Figure 13. Capacitive Load Transient/Response Test Circuit

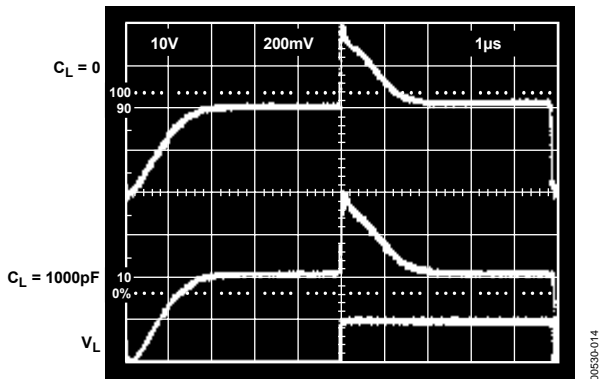

Figure 14. Output Response with Capacitive Load

LOAD REGULATION

The AD587 has excellent load regulation characteristics. Figure 15 shows that varying the load several milliamperes changes the output by only a few microvolts.



Figure 15. Typical Load Regulation Characteristics

TEMPERATURE PERFORMANCE

The AD587 is designed for precision reference applications where temperature performance is critical. Extensive temperature testing ensures that the device's high level of performance is maintained over the operating temperature range.

Some confusion exists in the area of defining and specifying reference voltage error over temperature. Historically, references have been characterized using a maximum deviation per degree Celsius, such as ppm/°C. However, because of nonlinearities in temperature characteristics that originated in standard Zener references (such as S-type characteristics), most manufacturers have begun to use a maximum limit error-band approach to specify devices. This technique involves the measurement of the output at three or more temperatures to specify an output voltage error band.

Each AD587J and AD587K grade unit is tested at 0°C, 25°C, and 70°C. Each AD587U grade unit is tested at -55°C, +25°C, and +125°C. This approach ensures that the variations of the output voltage that occur as the temperature changes within the specified range are contained within a box whose diagonal has a slope equal to the maximum specified drift. The position of the box on the vertical scale changes from device to device as initial error and the shape of the curve vary. The maximum height of the box for the appropriate temperature range and device grade is shown in Figure 16. Duplication of these results requires a combination of high accuracy and stable temperature control in a test system.

DEVICE GRADE	MAXIMUM OUTPUT CHANGE - mV	
	0 TO +70°C	-55°C TO +125°C
AD587J	14.00	
AD587K	7.00	
AD587U		9.00

Figure 16. Maximum Output Change in Millivolts

NEGATIVE REFERENCE VOLTAGE FROM AN AD587

The AD587 can be used as shown in Figure 17 to provide a precision -10.000 V output. The +V_{IN} pin is tied to at least a +3.5 V supply, the output pin is grounded, and the AD587 ground pin is connected through a resistor (R_S) to a -15 V supply. The -10 V output is taken from the ground pin (Pin 4) instead of V_{OUT}. It is essential to arrange the output load and the supply resistor (R_S) so that the net current through the AD587 is between 2.5 mA and 10.0 mA (R_S should be kept below 1 kΩ). The temperature characteristics and long-term stability of the device is essentially the same as that of a unit used in the standard 10 V output configuration.

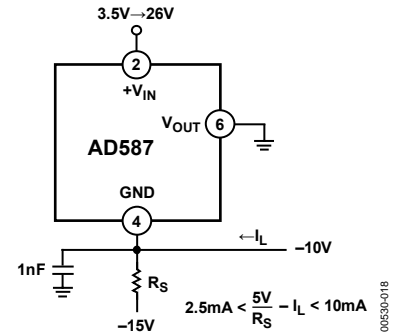

Figure 17. AD587 as a Negative 10 V Reference

APPLICATIONS INFORMATION

USING THE AD587 WITH CONVERTERS

The AD587 is an ideal reference for a variety of 8-bit, 12-bit, 14-bit, and 16-bit ADCs and DACs. Several examples follow.

10 V Reference with Multiplying CMOS DACs or ADCs

The AD587 is ideal for applications with 10-bit and 12-bit multiplying CMOS DACs. In the standard hookup, shown in Figure 18, the AD587 is paired with the AD7545 12-bit multiplying DAC and the AD711 high speed BiFET op amp. The amplifier DAC configuration produces a unipolar 0 V to -10 V output range. Bipolar output applications and other operating details can be found in the individual product data sheets.



Figure 18. Low Power 12-Bit CMOS DAC Application

The AD587 can also be used as a precision reference for multiple DACs. Figure 19 shows the AD587, the AD7628 dual DAC, and the AD712 dual op amp hooked up for single-supply operation to produce 0 V to -10 V outputs. Because both DACs are on the same die and share a common reference and output op amps, the DAC outputs will exhibit similar gain temperature coefficients (TCs).

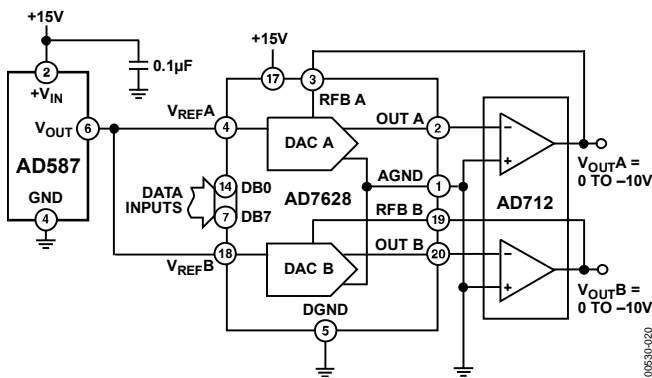

Figure 19. AD587 as a 10 V Reference for a CMOS Dual DAC

Precision Current Source

The design of the AD587 allows it to be easily configured as a current source. By choosing the control resistor (R_C) via the equation shown in Figure 20, the user can vary the load current from the quiescent current (2 mA typically) to approximately 10 mA.



Figure 20. Precision Current Source

Precision High Current Supply

For higher currents, the AD587 can easily be connected to a power PNP or power Darlington PNP device. The circuits in Figure 21 and Figure 22 can deliver up to 4 A to the load. The 0.1 µF capacitor is required only if the load has a significant capacitive component. If the load is purely resistive, improved high frequency supply rejection results can be obtained by removing the capacitor.



Figure 21. Precision High Current Source

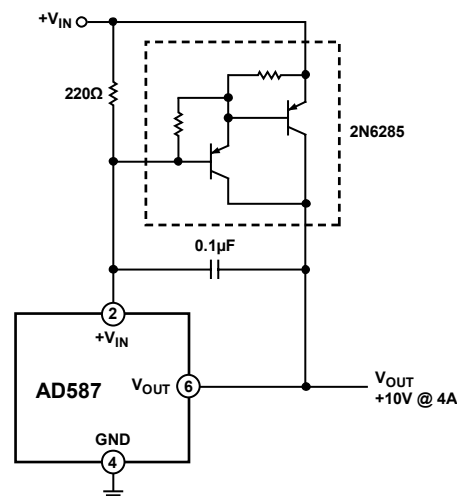

Figure 22. Precision High Current Voltage Source

OUTLINE DIMENSIONS



COMPLIANT TO JEDEC STANDARDS MS-012-AA

CONTROLLING DIMENSIONS ARE IN MILLIMETERS; INCH DIMENSIONS (IN PARENTHESES) ARE ROUNDED-OFF MILLIMETER EQUIVALENTS FOR REFERENCE ONLY AND ARE NOT APPROPRIATE FOR USE IN DESIGN.

Figure 23. 8-Lead Standard Small Outline Package [SOIC_N] Narrow Body (R-8)
Dimensions shown in millimeters and (inches)

012407-A



CONTROLLING DIMENSIONS ARE IN INCHES; MILLIMETER DIMENSIONS (IN PARENTHESES) ARE ROUNDED-OFF INCH EQUIVALENTS FOR REFERENCE ONLY AND ARE NOT APPROPRIATE FOR USE IN DESIGN.

Figure 25. 8-Lead Ceramic Dual In-Line Package [CERDIP] (Q-8)
Dimensions shown in inches and (millimeters)



COMPLIANT TO JEDEC STANDARDS MS-001

CONTROLLING DIMENSIONS ARE IN INCHES; MILLIMETER DIMENSIONS (IN PARENTHESES) ARE ROUNDED-OFF INCH EQUIVALENTS FOR REFERENCE ONLY AND ARE NOT APPROPRIATE FOR USE IN DESIGN. CORNER LEADS MAY BE CONFIGURED AS WHOLE OR HALF LEADS.

Figure 24. 8-Lead Plastic Dual In-Line Package [PDIP] Narrow Body (N-8)
Dimensions shown in inches and (millimeters)

070606-A

AD587

ORDERING GUIDE

Model	Initial Error	Temperature Coefficient	Temperature Range	Package Description	Package Option
AD587JQ	10 mV	20 ppm/°C	0°C to 70°C	8-Lead CERDIP	Q-8
AD587JR	10 mV	20 ppm/°C	0°C to 70°C	8-Lead SOIC_N	R-8
AD587JR-REEL	10 mV	20 ppm/°C	0°C to 70°C	8-Lead SOIC_N	R-8
AD587JR-REEL7	10 mV	20 ppm/°C	0°C to 70°C	8-Lead SOIC_N	R-8
AD587JRZ ¹	10 mV	20 ppm/°C	0°C to 70°C	8-Lead SOIC_N	R-8
AD587JRZ-REEL ¹	10 mV	20 ppm/°C	0°C to 70°C	8-Lead SOIC_N	R-8
AD587JRZ-REEL7 ¹	10 mV	20 ppm/°C	0°C to 70°C	8-Lead SOIC_N	R-8
AD587JN	10 mV	20 ppm/°C	0°C to 70°C	8-Lead PDIP	N-8
AD587JNZ ¹	10 mV	20 ppm/°C	0°C to 70°C	8-Lead PDIP	N-8
AD587KR	5 mV	10 ppm/°C	0°C to 70°C	8-Lead SOIC_N	R-8
AD587KR-REEL	5 mV	10 ppm/°C	0°C to 70°C	8-Lead SOIC_N	R-8
AD587KR-REEL7	5 mV	10 ppm/°C	0°C to 70°C	8-Lead SOIC_N	R-8
AD587KRZ ¹	5 mV	10 ppm/°C	0°C to 70°C	8-Lead SOIC_N	R-8
AD587KRZ-REEL ¹	5 mV	10 ppm/°C	0°C to 70°C	8-Lead SOIC_N	R-8
AD587KRZ-REEL7 ¹	5 mV	10 ppm/°C	0°C to 70°C	8-Lead SOIC_N	R-8
AD587KN	5 mV	10 ppm/°C	0°C to 70°C	8-Lead PDIP	N-8
AD587KNZ ¹	5 mV	10 ppm/°C	0°C to 70°C	8-Lead PDIP	N-8
AD587UQ	5 mV	5 ppm/°C	-55°C to +125°C	8-Lead CERDIP	Q-8

¹ Z = RoHS Compliant Part.