

RT7298BHGQW Evaluation Board

Purpose

The RT7298BH is a synchronous step-down converter with current mode control, which can deliver up to 6A output current from a wide input voltage range of 4.5V to 18V. This document explains the function and use of the RT7298BH evaluation board (EVB) and provides information to enable operation and modification of the evaluation board and circuit to suit individual requirements.

Table of Contents

PURPOSE.....	1
INTRODUCTION.....	2
KEY PERFORMANCE SUMMARY TABLE.....	2
BENCH TEST SETUP CONDITIONS.....	3
SCHEMATIC, BILL OF MATERIALS AND BOARD LAYOUT.....	5
MORE INFORMATION.....	10
IMPORTANT NOTICE FOR RICHTEK REFERENCE DESIGNS.....	10

Introduction

General Product Information

The RT7298BH is a high efficiency, monolithic synchronous step-down DC/DC converter that can deliver up to 6A output current from a 4.5V to 18V input supply. The RT7298BH current-mode architecture with external compensation allows the transient response to be optimized over a wide range of loads and output capacitors. Cycle-by-cycle current limit provides protection against shorted outputs and soft-start eliminates input current surge during startup. Fault condition protections include output under-voltage protection, output over-voltage protection, and over temperature protection. The low current shutdown mode provides output disconnection, enabling easy power management in battery-powered systems. The RT7298BH is available in WQFN-14AL 3.5x3.5 package.

Product Feature

- Low $R_{DS(ON)}$ Power MOSFET Switches 26m Ω /19m Ω
- Input Voltage Range : 4.5V to 18V
- Adjustable Switching Frequency : 200kHz to 1.6MHz
- Current-Mode Control
- Synchronous to External Clock : 200kHz to 1.6MHz
- Accurate Voltage Reference : 0.6V \pm 1.25%
- Monotonic Start-Up into Pre-biased Outputs
- Adjustable Soft-Start
- Power Good Indicator
- Under-Voltage and Over-Voltage Protection
- Input Under-Voltage Lockout
- RoHS Compliant and Halogen Free

Key Performance Summary Table

Key Features	Evaluation Board Number: PCB006_V1
Default Input Voltage	12V
Max Output Current	6A
Default Output Voltage	1.0V
Default Marking & Package Type	RT7298BHGQW, WQFN-14AL 3.5x3.5
Operation Frequency	Steady 500kHz at all loads
Other Key Features	4.5V to 18V Input Voltage Range Programmable Soft-Start, Adjustable Switching Frequency Synchronous to External Clock Power Good Indicator
Protection	Output Under-Voltage Protection (hiccup mode) Output Over-Voltage Protection Cycle-by-cycle Current Limit Thermal Shutdown

Bench Test Setup Conditions

Headers Description and Placement

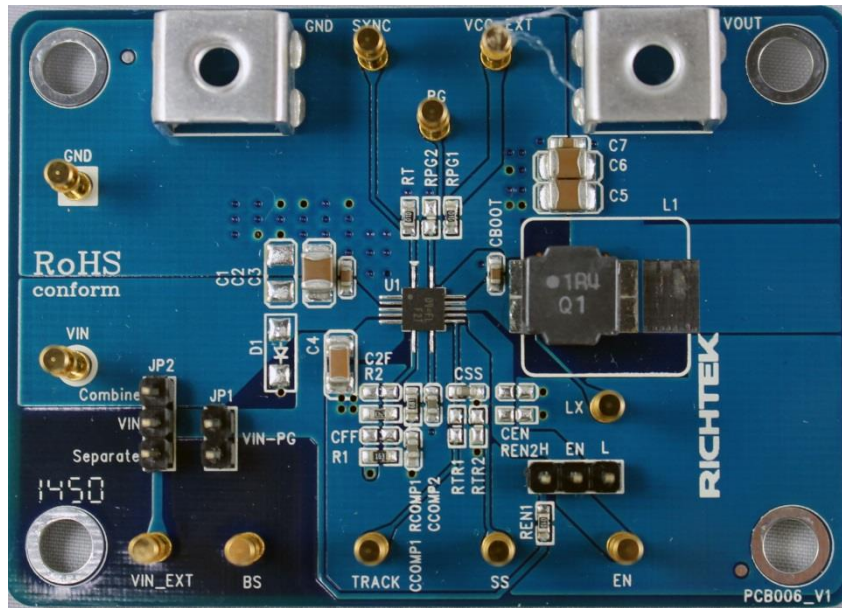

Please carefully inspect the EVB IC and external components, comparing them to the following Bill of Materials, to ensure that all components are installed and undamaged. If any components are missing or damaged during transportation, please contact the distributor or send e-mail to evb_service@richtek.com

Test Points

The EVB is provided with the test points and pin names listed in the table below.

Test point/ Pin name	Signal	Comment (expected waveforms or voltage levels on test points)
VIN, VIN_EXT	Input voltage	Input voltage range= 4.5V to 18V
VOUT	Output voltage	Default output voltage = 1.0V Output voltage range= 0.6V to 8V (see " Output Voltage Setting" section for changing output voltage level)
LX	Switching node test point	LX waveform
EN	Enable test point	Enable signal. Floating this EN pin or connecting this pin to pull high enable operation; connecting this pin to GND can disable the device.
SYNC	Ext Frequency Sync Input	External Frequency Synchronization Input. Connecting external clock to this pin changes the switching frequency.
BS	Boot strap supply test point	Floating supply voltage for the high-side N-MOSFET switch
GND	Ground	Ground
SS	Soft-start control test point	Soft start waveform
VCC_EXT	External Voltage for PG	External voltage terminal for PG pull-up voltage.
PG	Power good output test point	Connected to VCC_EXT through RPG1, Power Good Indicator
JP2	VIN & PVIN control	Install jumper to combine or separate VIN and PVIN.
JP1	PG control	VIN voltage terminal for PG pull-up voltage.
J9	Chip enable control	Install jumper or drive EN directly to enable or disable operation

Power-up & Measurement Procedure

1. Connect input power ($4.5V < V_{IN} < 18V$) and input ground to VIN and GND test pins respectively.
2. Connect positive end and negative terminals of load to VOUT and GND test pins respectively.
3. There is a 3-pin header “EN” for enable control. To use a jumper at “H” option to tie EN test pin to input power VIN for enabling the device. Inversely, to use a jumper at “L” option to tie EN test pin and ground GND for disabling the device.
4. The PVIN and VIN pins can be connected together using a jumper across “Combine” by the 3-pin header JP2. Inversely, these two input rails can be separated by using a jumper across “Separate” if desired.
5. The 2-pin header JP1 “VIN-PG” is for PGOOD pin supply, when using a jumper across this header, the PG signal can be supplied by VIN pin Voltage.
6. Verify the output voltage (approximately 1.0V) between VOUT and GND.
7. Connect an external load up to 6A to the VOUT and GND terminals and verify the output voltage and current.

Output Voltage Setting

Set the output voltage with the resistive divider (R_1 , R_2) between VOUT and GND with the midpoint connected to FB. The output is set by the following formula:

$$V_{OUT} = 0.6 \times \left(1 + \frac{R_1}{R_2}\right)$$

The installed VOUT capacitors (C_5 , C_6) are 22 μ F, 16V X5R ceramic types. Do not exceed their operating voltage range and consider their voltage coefficient (capacitance vs. bias voltage) and ensure that the capacitance is sufficient to maintain stability and provide sufficient transient response for your application. This can be verified by checking the output transient response as described in the RT7298B IC datasheet.

Schematic, Bill of Materials & Board Layout

EVB Schematic Diagram

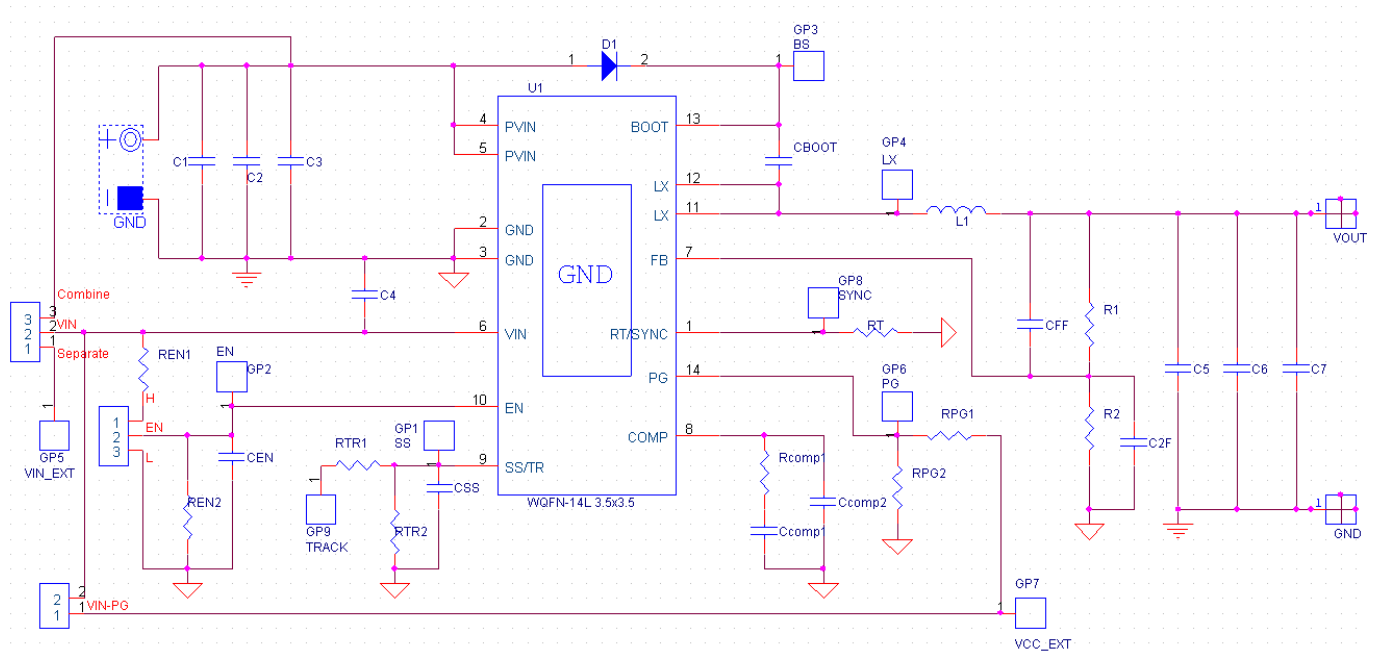

- C4: 10 μ F/50V/X5R, 1206, TDK C3216X5R1H106K
- C2, C5, C6: 22 μ F/16V/X5R, 1210, Murata GRM32ER61C226K
- L1: 1.4 μ H TAIYO YUDEN NR8040T1R4N, DCR=7m Ω

Bill of Materials

Reference	Qty	Part number	Description	Package	Manufacture
U1	1	RT7298BHGQW	DC-DC Converter	WQFN-14AL 3.5x3.5	RICHTEK
C4	1	C3216X5R1H106K160AB	10 μ F/ \pm 10%/50V/X5R Ceramic Capacitor	1206	TDK
C2, C5, C6	3	GRM32ER61C226KE20#	22 μ F/ \pm 10%/16V/X5R Ceramic Capacitor	1210	Murata
CSS	1	GRM32MR71H103KA01#	10nF/ \pm 10%/50V/X7R Ceramic Capacitor	0603	Murata
C _{COMP1}	1	GRM31CR71A822KA01	8.2nF/ \pm 10%/50V/X7R Ceramic Capacitor	0603	Murata
C _{COMP2}	1	0603B181K500CT	180pF/ \pm 10%/50V/X7R Ceramic Capacitor	0603	WALSIN
C3, C7, CBOOT	3	C1608X7R1H104K080AA	0.1 μ F/ \pm 10%/50V/X7R Ceramic Capacitor	0603	TDK
C1, CFF, C2F, CEN, REN2, RTR1, RTR2, RPG2, D1	0		Not Installed	0603	
L1	1	NR8040T1R4N	1.4 μ H/9.0A/ \pm 30%, DCR=7m Ω , Inductor	8mmx8mmx4mm	TAIYO YUDEN
R1	1		16k Ω / \pm 1%, Resistor	0603	
R2	1		24k Ω / \pm 1%, Resistor	0603	
R _{COMP}	1		0.68k Ω / \pm 1%,	0603	
RT, REN1, RPG1	3		100k Ω / \pm 1%,	0603	
JP1	1		2-Pin Header		
JP2, J9	2		3-Pin Header		
GP	11	VIN_EXT, BS, SS, TRACK, EN, LX, SYNC, PG, VCC_EXT, VIN, GND	Golden Pin		
J3, J4	2	VOUT, GND	Test Pin		

EVB Layout

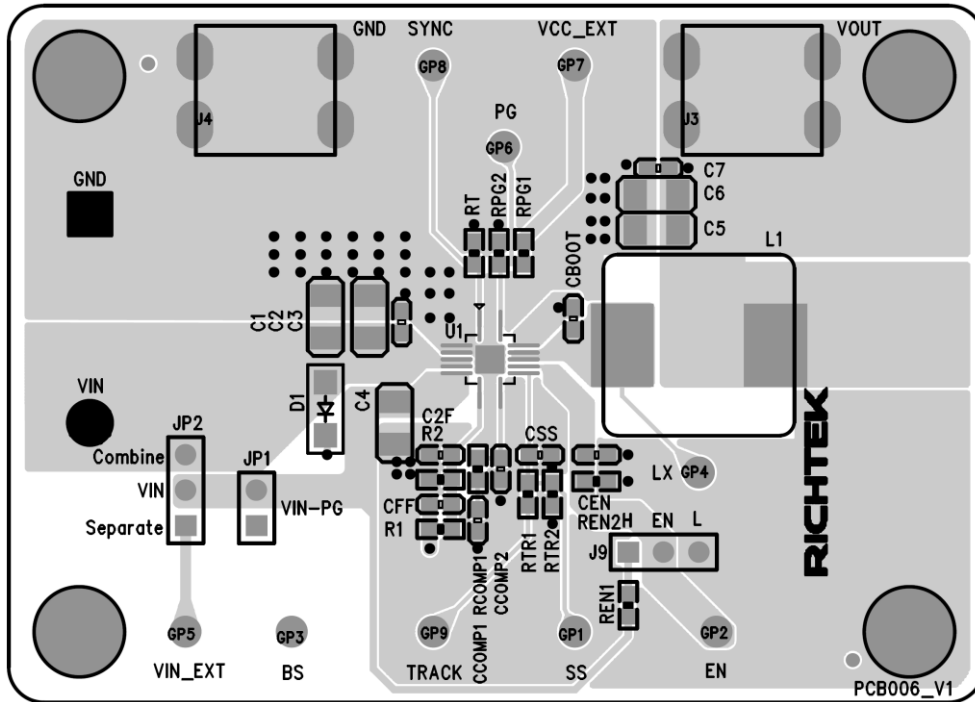

Top View (1st layer)

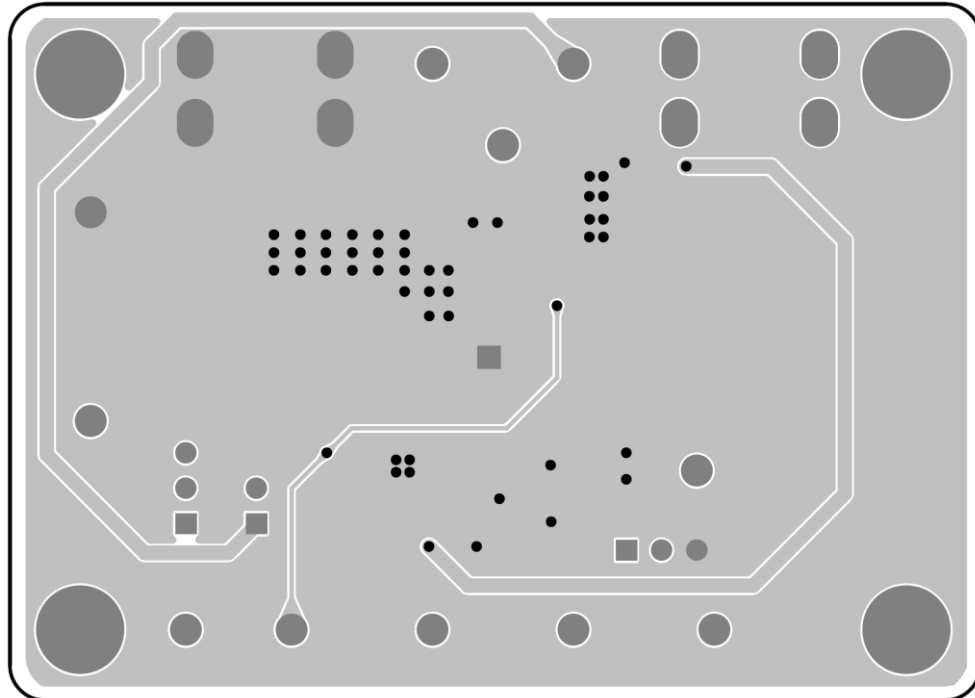

Bottom View (4th Layer)

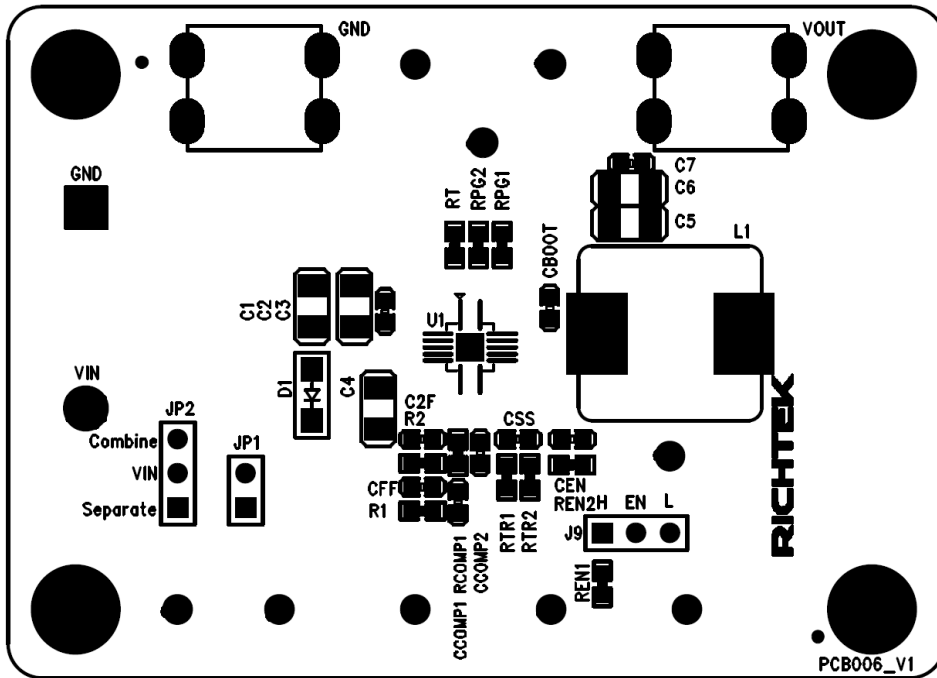

Component Placement Guide—Component Side (1st layer)

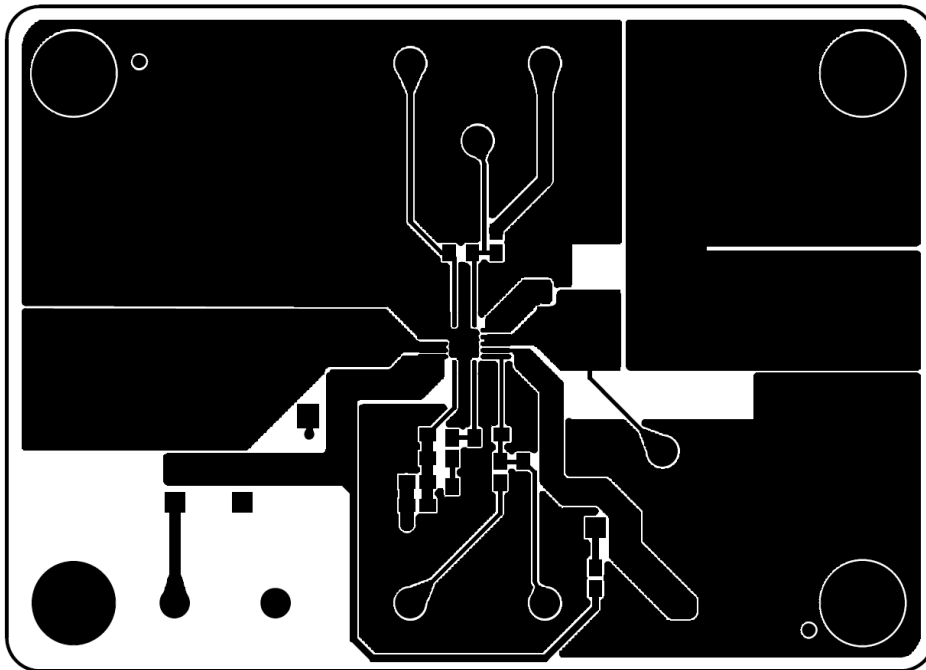

PCB Layout—Component Side (1st Layer)

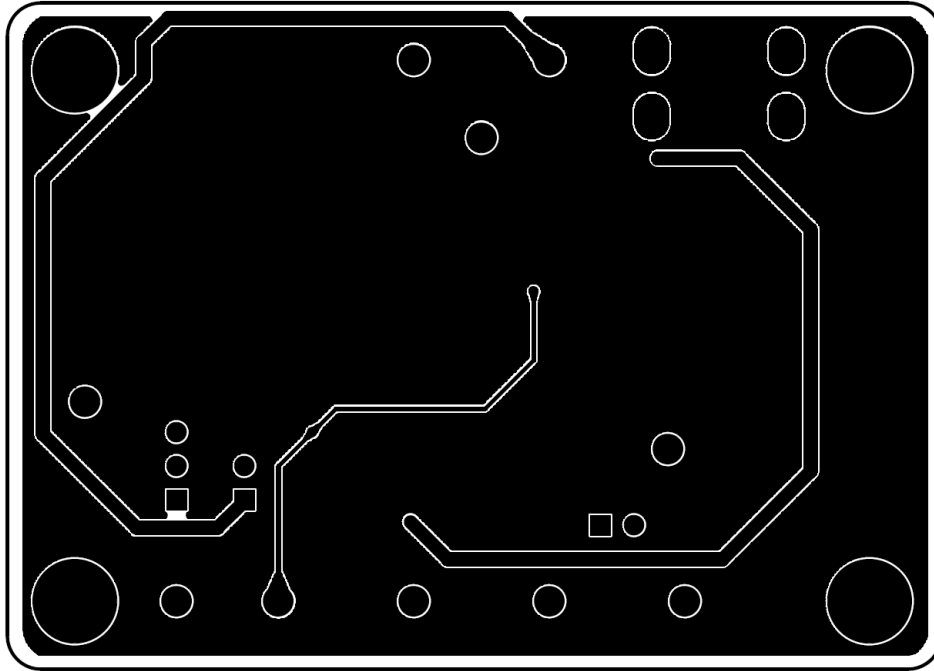

PCB Layout—Bottom Side (4th layer)

More Information

For more information, please find the related datasheet or application notes from Richtek website <http://www.richtek.com>.

Important Notice for Richtek Evaluation Board

THIS DOCUMENT IS FOR REFERENCE ONLY, NOTHING CONTAINED IN THIS DOCUMENT SHALL BE CONSTRUED AS RICHTEK'S WARRANTY, EXPRESS OR IMPLIED, UNDER CONTRACT, TORT OR STATUTORY, WITH RESPECT TO THE PRESENTATION HEREIN. IN NO EVENT SHALL RICHTEK BE LIABLE TO BUYER OR USER FOR ANY AND ALL DAMAGES INCLUDING WITHOUT LIMITATION TO DIRECT, INDIRECT, SPECIAL, PUNITIVE OR CONSEQUENTIAL DAMAGES.