

Package: QFN, 6 mmx6 mm



Product Description

RFMD's SZM-3166Z is a high linearity class AB Heterojunction Bipolar Transistor (HBT) amplifier housed in a low-cost surface-mountable plastic Q-FlexN multi-chip module package. This HBT amplifier is made with InGaP on GaAs device technology and fabricated with MOCVD for an ideal combination of low cost and high reliability. This product is specifically designed for 802.16 customer premises equipment (CPE) terminals in the 3.3GHz to 3.6GHz bands. It can run from a 3V to 5.2V supply. The external output match and bias adjustability allows load line optimization for other applications covering 3.5GHz to 3.8GHz. It features an output power detector, on/off power control and high RF overdrive robustness. A 20dB step attenuator feature can be utilized by switching the second stage Power up/down control. This product features a RoHS compliant and Green package with matte tin finish, designated by the 'Z' suffix.

Optimum Technology Matching® Applied

- GaAs HBT
- GaAs MESFET
- InGaP HBT
- SiGe BiCMOS
- Si BiCMOS
- SiGe HBT
- GaAs pHEMT
- Si CMOS
- Si BJT
- GaN HEMT
- RF MEMS

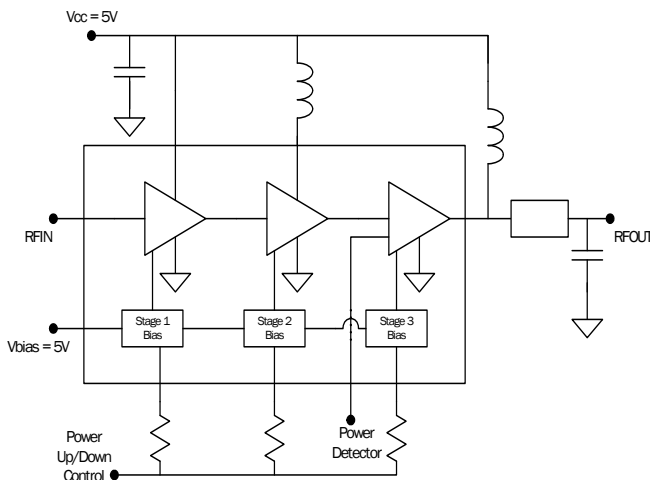

Features

- $P_{1dB} = 35 \text{ dBm}$ at 5.2V
- Three Stages of Gain: 35 dB
- 802.11g 54 Mb/s Class AB Performance
- $P_{OUT} = 27 \text{ dBm}$ at 2.5% EVM, $V_{CC} = 5.2\text{V}$, 900 mA
- Active Bias with Adjustable Current
- On-Chip Output Power Detector
- Low Thermal Resistance
- Power Up/Down Control $< 1\mu\text{s}$
- Attenuator Step 20 dB at $V_{PC2} = 0\text{V}$
- Class 1C ESD Rating

Applications

- 802.16 WiMAX Driver or Output Stage
- Fixed Wireless, WLL
- CPE Terminal Applications

Parameter	Specification			Unit	Condition
	Min.	Typ.	Max.		
Frequency of Operation	3300		3600	MHz	
Output Power at 1dB Compression		34.5		dBm	3.5 GHz
Gain	32.0	35.0	38.0	dBm	3.5 GHz, $P_{OUT} = 26 \text{ dBm}$
% EVM		2.5		%	3.5 GHz, $P_{OUT} = 27 \text{ dBm}$, 802.11g 54 Mb/s
Third Order Suppression		-42	-37	dBc	3.5 GHz, $P_{OUT} = 23 \text{ dBm}$ per tone
Noise Figure		5.0		dB	3.5 GHz
Worst Case Input Return Loss	11.0	14.0		dB	2.3 GHz to 3.5 GHz
Worst Case Output Return Loss	6.0	9.0		dB	2.3 GHz to 3.5 GHz
Supply voltage rang		5.2		V	
Output Voltage Range		0.9 to 2.2		V	$P_{OUT} = 10 \text{ dBm}$ to 33 dBm
Quiescent Current	720	800	880	mA	$V_{CC} = 5.2\text{V}$
Power Up Control Current		5.0		mA	$V_{PC} = 5.2\text{V}$, $I_{VCP1} + I_{VPC2} + I_{VPC3}$
V_{CC} Leakage Current			0.1	μA	$V_{CC} = 5.2\text{V}$, $V_{PC} = 0\text{V}$
Thermal Resistance		12.0		$^{\circ}\text{C}/\text{W}$	junction - lead

Test Conditions: $Z_0 = 50\Omega$, $V_{CC} = 5.2\text{V}$, $I_Q = 800\text{mA}$, $T_{BP} = 30^{\circ}\text{C}$

Absolute Maximum Ratings

Parameter	Rating	Unit
VC3 Collector Bias Current (I_{VC3})	1500	mA
VC2 Collector Bias Current (I_{VC2})	600	mA
VC1 Collector Bias Current (I_{VC1})	300	mA
**Device Voltage (V_D)	9.0	V
Power Dissipation (P_{DISS})	6	W
Operating Temp Range (T_L)	-40 to +85	°C
*Max RF output Power for 50Ω continuous long term operation	30	dBm
Max RF Input Power (CW) for 50Ω output load	29	dBm
Max RF input Power for 10:1 VSWR output load	5	dBm
Max Storage Temp	+150	°C
Operating Junction Temperature (T_J)	+150	°C
ESD Rating - Human Body Model (HBM)	Class IC	



Caution! ESD sensitive device.

Exceeding any one or a combination of the Absolute Maximum Rating conditions may cause permanent damage to the device. Extended application of Absolute Maximum Rating conditions to the device may reduce device reliability. Specified typical performance or functional operation of the device under Absolute Maximum Rating conditions is not implied.

RoHS status based on EU Directive 2002/95/EC (at time of this document revision).

The information in this publication is believed to be accurate and reliable. However, no responsibility is assumed by RF Micro Devices, Inc. ("RFMD") for its use, nor for any infringement of patents, or other rights of third parties, resulting from its use. No license is granted by implication or otherwise under any patent or patent rights of RFMD. RFMD reserves the right to change component circuitry, recommended application circuitry and specifications at any time without prior notice.

*With specified application circuit

**No RF Drive

Operation of this device beyond any one of these limits may cause permanent damage. For reliable continuous operation, the device voltage and current must not exceed the maximum operating values specified in the table on page one.

Bias Conditions should also satisfy the following expression:

$$I_D V_D < (T_J - T_L) / R_{TH, j}$$

Typical Performance 3.3GHz to 3.6GHz App Circuit ($V_{CC}=5.2V$, $I_{CQ}=800mA$, *802.11g 54Mb/s 64QAM)

Parameter	Unit	3.3GHz	3.4GHz	3.5GHz	3.6GHz	3.7GHz	3.8GHz
Gain @ $P_{OUT}=26dBm$	dB	35	35	35	35	33	31.5
P_{1dB}	dBm	34.0	34.5	35.0	34.5	34.0	33.0
% EVM @ $P_{OUT}=27dBm^*$	%	2.7	2.5	2.5	2.6	3.1	4.0
Current @ P_{OUT} 2.5% EVM*	mA	930	930	920	893	910	885
Input Return Loss	dB	14.0	15.0	15.5	17.0	18.5	15.5
Output Return Loss	dB	9	10	10	9	8	7

Simplified Device Schematic

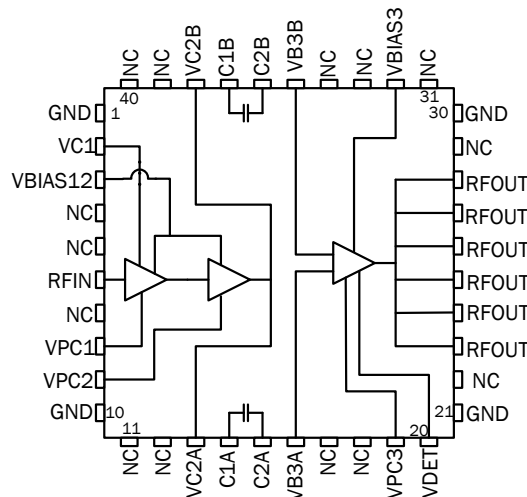

Measured 3.3GHz to 3.6GHz Application Circuit Data ($V_{CC}=V_{PC}=5.2V$, $I_Q=800mA$, $T=25^\circ C$)

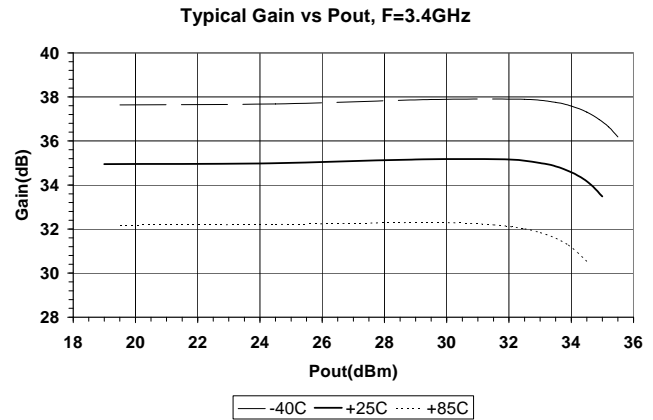
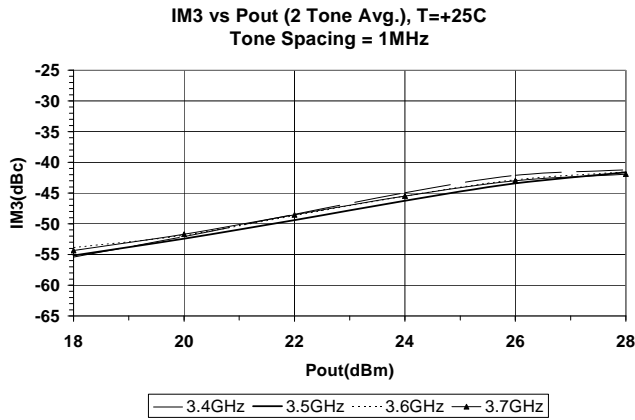
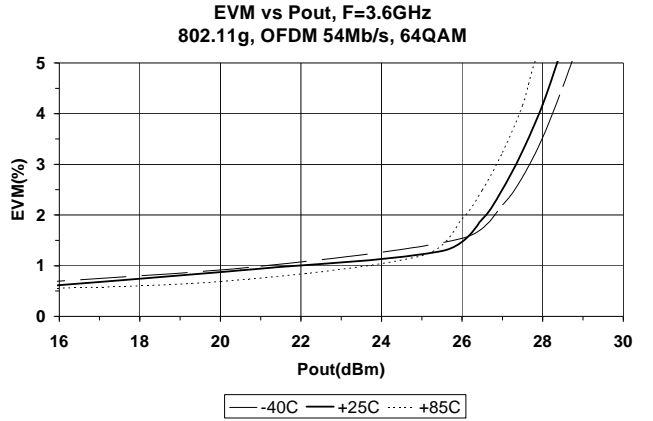
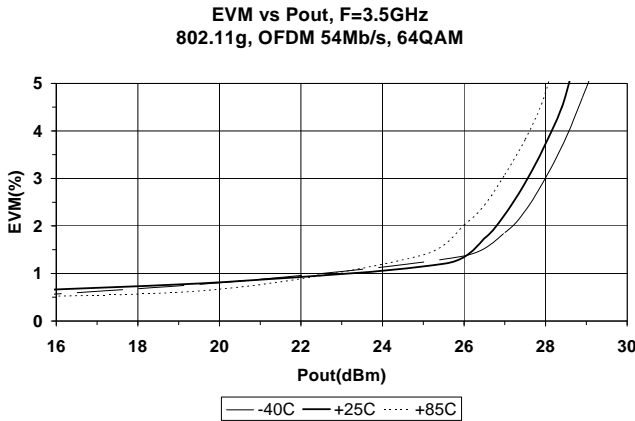
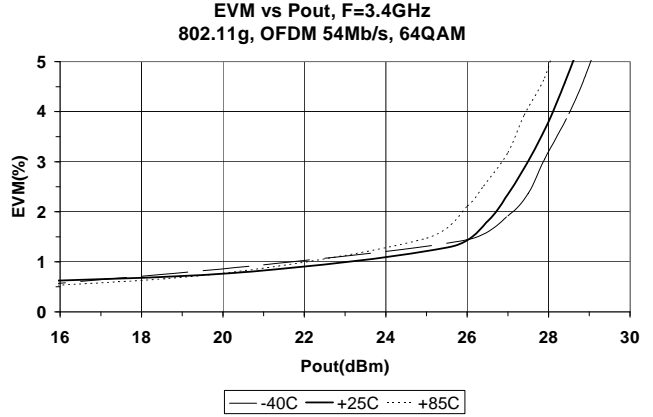
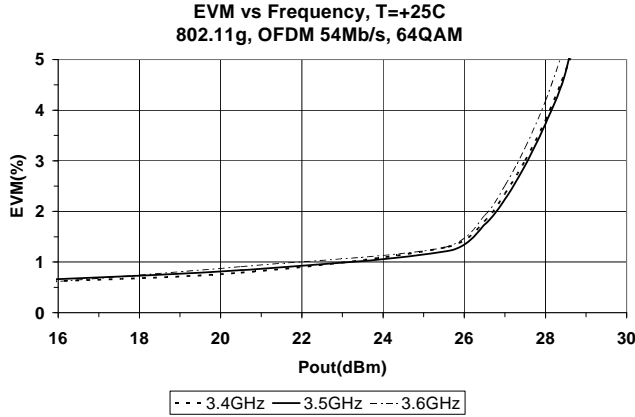

Measured 3.3GHz to 3.6GHz Application Circuit Data ($V_{CC}=V_{PC}=5.2V$, $I_Q=800mA$, $T=25^\circ C$)

Typical Gain vs Pout, F=3.5GHz

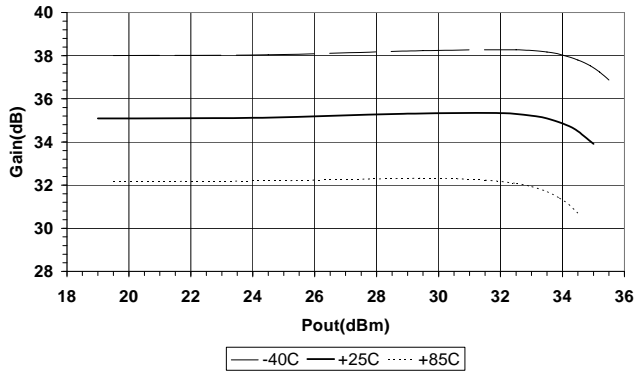

Typical Gain vs Pout, F=3.6GHz

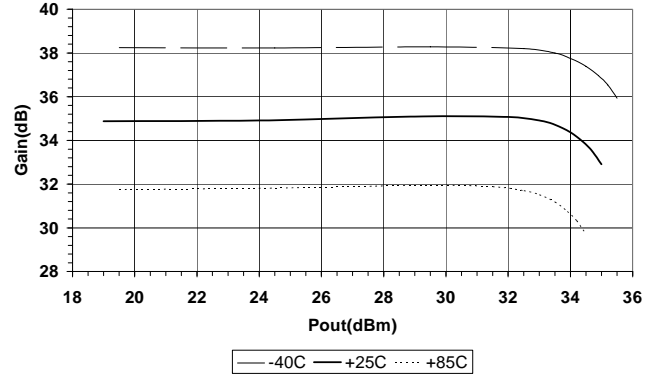

Narrowband S11 - Input Return Loss

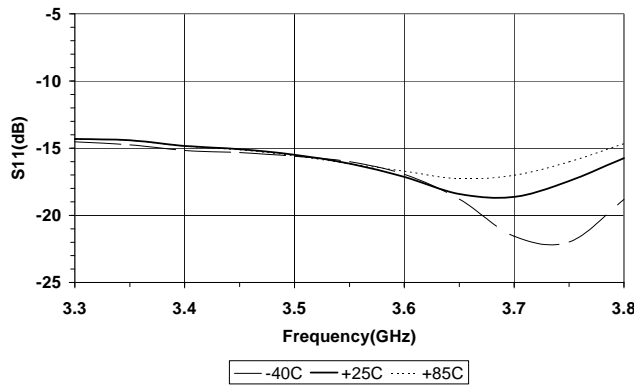

Narrowband S21 - Forward Gain

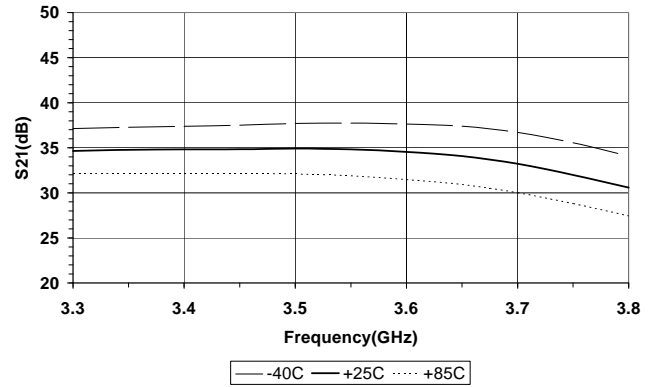

Narrowband S12 - Reverse Isolation

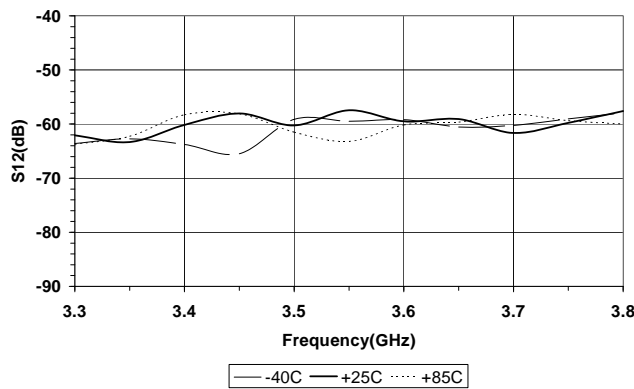

Narrowband S22 - Output Return Loss

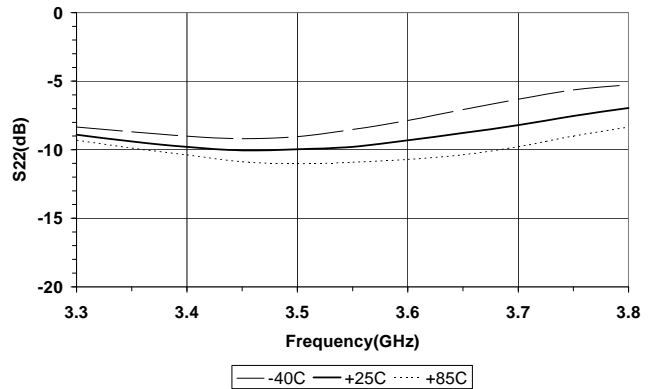

Measured 3.3GHz to 3.6GHz Application Circuit Data ($V_{CC}=V_{PC}=5.2V$, $I_Q=800mA$, $T=25^\circ C$)

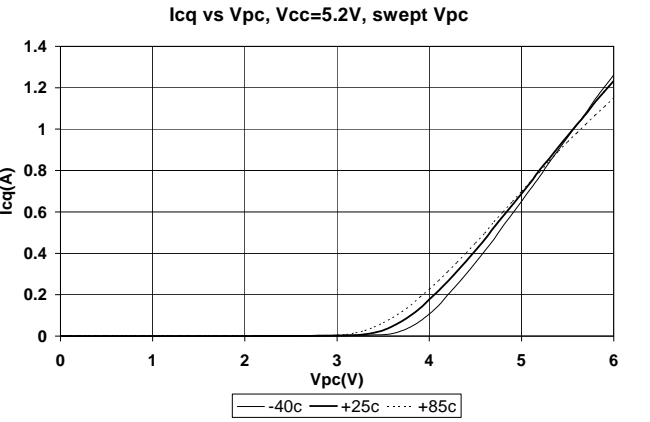
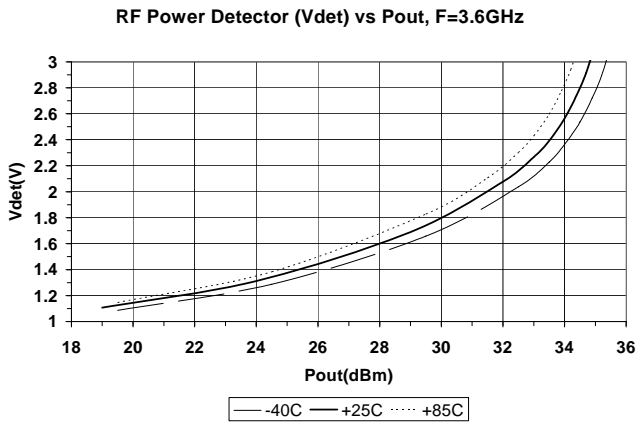
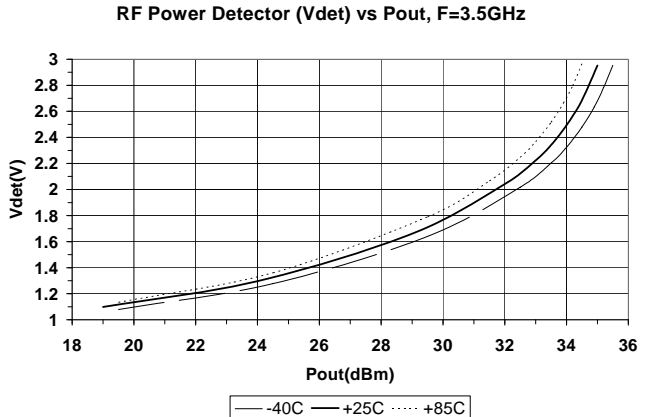
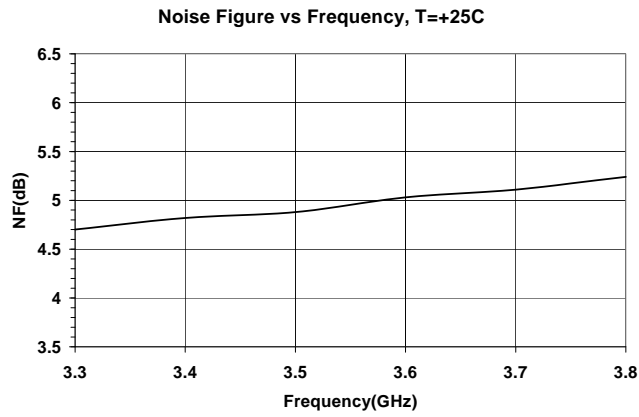
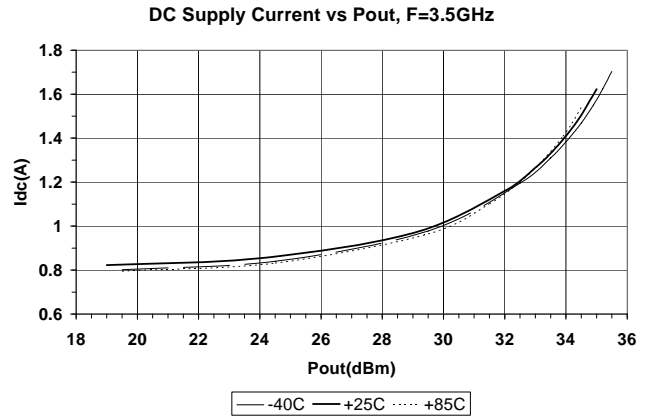
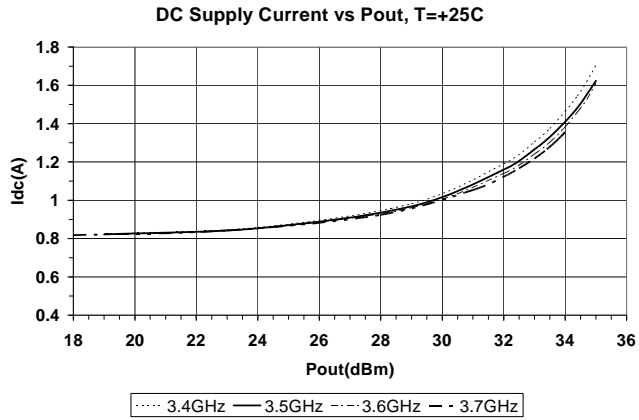

Measured 3.3GHz to 3.6GHz Application Circuit Data ($V_{CC}=V_{PC}=5.2V$, $I_Q=800mA$, $T=25^\circ C$)

Broadband S11 - Input Return Loss

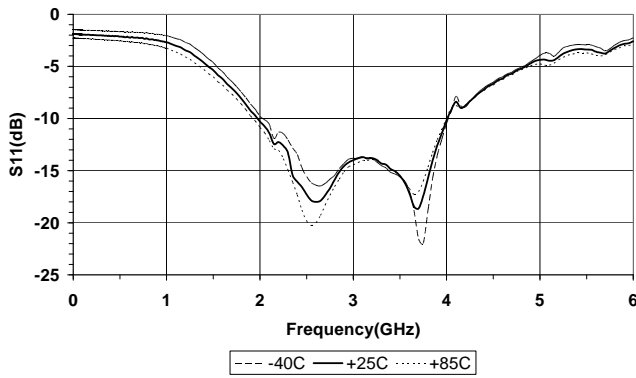

Broadband S21 - Forward Gain

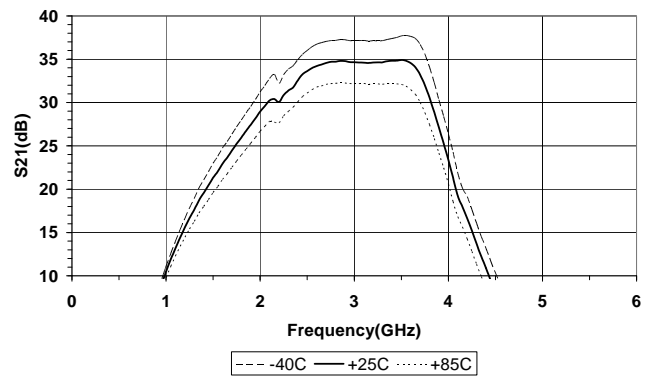

Broadband S12 - Reverse Isolation

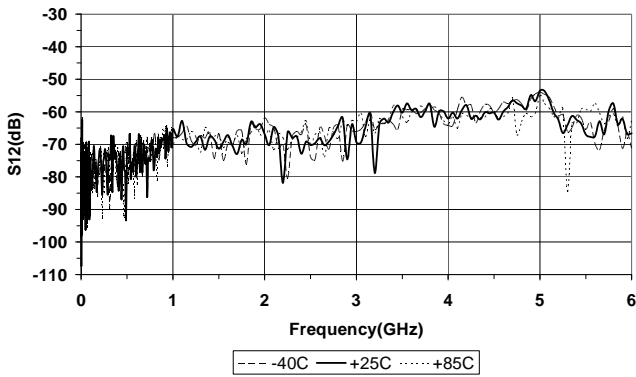

Broadband S22 - Output Return Loss

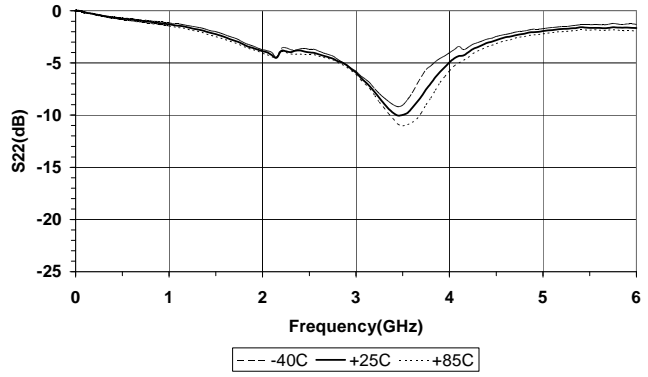

20dB Step attenuator Function Gain Delta vs Temp.
Attenuator Enabled VPC2=0V

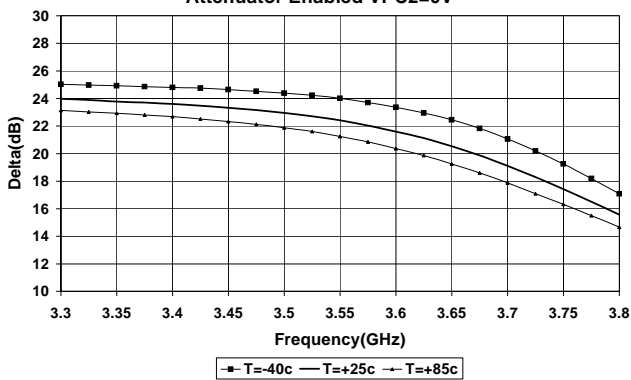

Pin	Function	Description
5, 7, 11, 12, 17, 18, 22, 29, 31, 33, 34, 39, 40	NC	These are no connect (NC) pins and are not wired inside the package. It is recommended to connect them as shown in the application circuit to achieve the stated performance.
1, 10, 21, 30	GND	These pins are internally grounded inside the package to the backside ground paddle. It is recommended to also ground them external to the package to achieve the specified performance.
2	VC1	This is the collector of the first stage.
3	VBIAS12	This is the supply voltage for the active bias circuit of the 1st and 2nd stages.
4	NC	This pin is not connected inside the package, but it is recommended to connect it to GND to achieve the specified performance.
6	RF IN	This is the RF input pin. It is DC grounded inside the package. Do not apply DC voltage to this pin.
8	VPC1	Power up/down control pin for the 1st stage. An external series resistor is required for proper setting of bias levels depending on control voltage. The voltage on this pin should never exceed the voltage on pin 3 by more than 0.5V unless the supply current from pin 3 is limited < 10mA.
9	VPC2	Power up/down control pin for the 2nd stage. Power down $V_{PC2} < 1V$ for step attenuator functionable. An external series resistor is required for proper setting of bias levels depending on control voltage. The voltage on this pin should never exceed the voltage on pin 3 by more than 0.5V unless the supply current from pin 3 is limited < 10mA.
13, 38	VC2A, VC2B	These two pins are connected internal to the package to the 2nd stage collector. To achieve specified performance, the layout of these pins should match the Recommended Land Pattern.
14, 15, 36, 37	C1A,C2A C1B,C2B	These pins have capacitors across them internal to the package as shown in the below schematic. They are used as tuning and RF coupling elements between the 2nd and 3rd stage.
16, 35	VB3A, VB3B	These are the connections to the base of the 3rd stage output device. To achieve specified performance, the layout of these pins should match the Recommended Land Pattern.
19	VPC3	Power up/down control pin for the 3rd stage. An external series resistor is required for proper setting of bias levels depending on control voltage. The voltage on this pin should never exceed the voltage on pin 32 by more than 0.5V unless the supply current from pin 33 is limited < 10mA.
20	VDET	This is the output port for the power detector. It samples the power at the input of the 3rd stage.
23-28	RF OUT	These are the RF output pins and DC connections to the 3rd stage collector.
32	VBIAS3	This is the supply voltage for the active bias circuit of the 3rd stage.

Recommended Metal Land Pattern

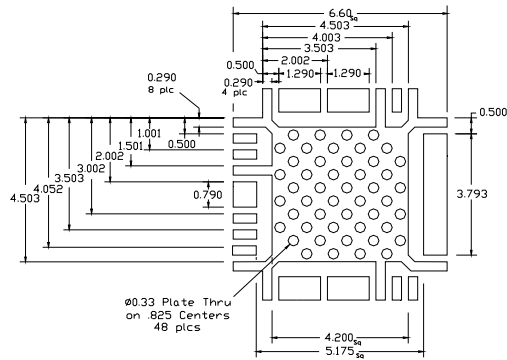

Recommended PCB Soldermask for Land Pattern

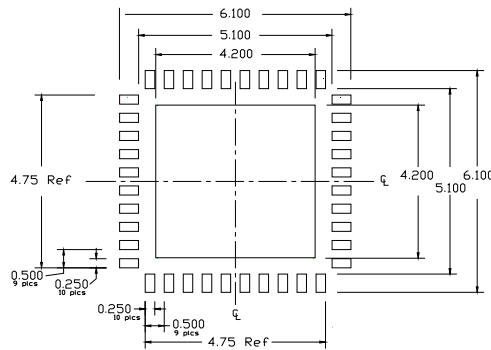

Package Drawing

Dimensions in inches (millimeters)

Refer to drawing posted at www.rfmd.com for tolerances.

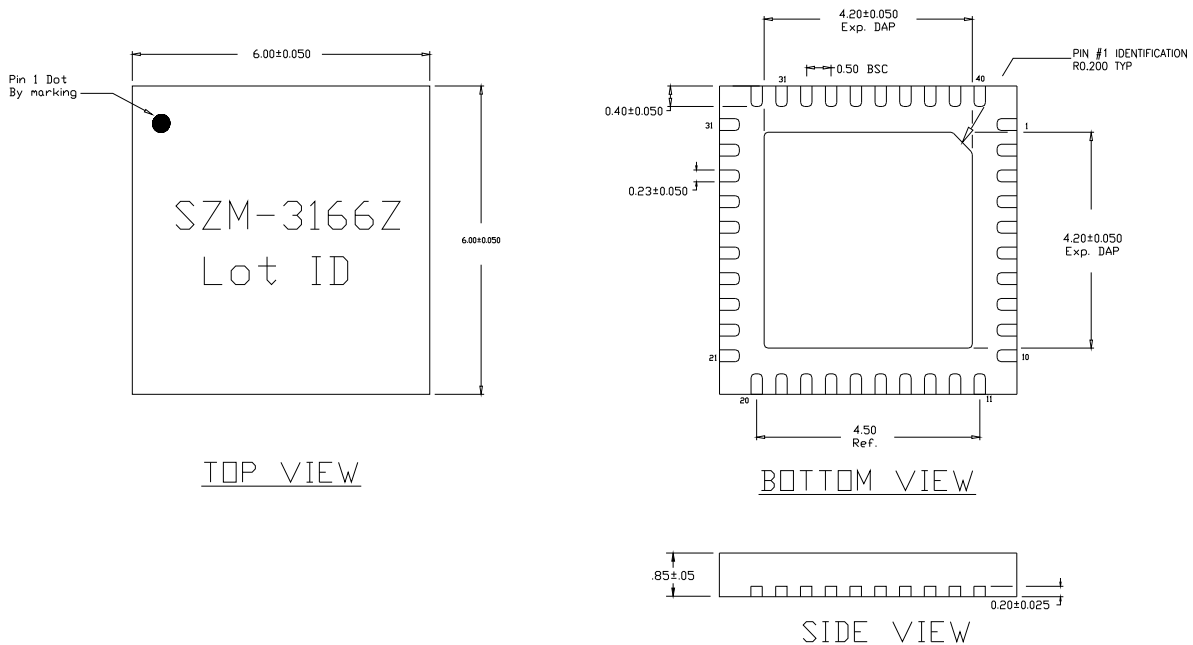

3.3GHz to 3.6GHz Evaluation Board Schematic for $V_{CC}=V_{PC}=5.2V$

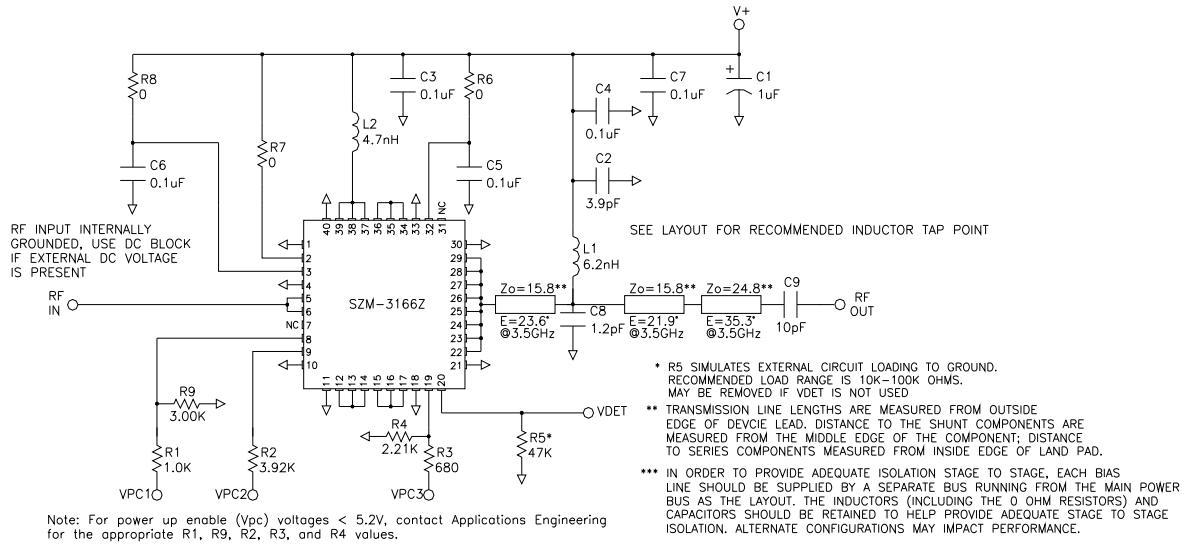

Evaluation Board Layout and Bill of Materials for $V_{CC}=V_{PC}=5.2V$

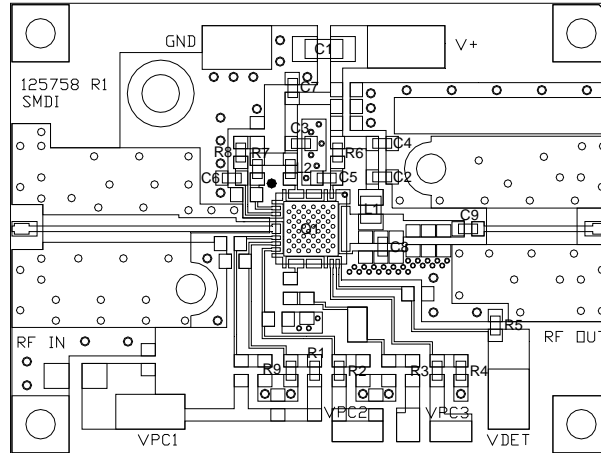

Bill of Materials

Desg	Description	Notes
Q1	SZM-3166Z	6mmx6mm QFN
R1	1.0KΩ, 0603 1%	0402 may be used
R2	3.92KΩ, 0603 1%	0402 may be used
R3	680Ω, 0603 1%	0402 may be used
R4	2.21KΩ, 0603 1%	0402 may be used
R5	47KΩ, 0603	0402 may be used
R6, 7, 8	0Ω, 0603	0402 may be used
R9	3kW, 0603 1%	0402 may be used
C1	1uF 16V MLCC CAP	Tantalum ok for EVM performance. Use MLCC type for best IM3 levels.
C2	3.9pF CAP, 0603	NPO, ROHM MCH185A3R9DK or equivalent
C3, 4, 5, 6, 7	0.1uF CAP, 0603	X7R 0402 ok, ROHM MCH182CN104K or equivalent
C8	1.2pF CAP, 0603	NPO, low ESR, ATC 60052R4CW250 or equivalent
C9	10pF CAP, 0603	NPO, low EST, ATC 6005100JW250 or equivalent
L1	6.2nH IND 0805	Coilcraft 0805HQ - 6N2XJBB
L2	4.7nH IND, 0603	TOKO 0603 - LL1608FH4N7J

Part Symbolization

The part will be symbolized with “SZM-3166Z” to designate it as an RoHS green compliant product. Marking designator will be on the top surface of the package.

Ordering Information

Ordering Code	Description
SZM3166ZSQ	Standard 25 piece bag
SZM3166ZSR	Standard 100 piece reel
SZM3166Z	Standard 1000 piece reel
SZM3166ZPCK-EVB1	Evaluation Board 3.3GHz to 3.8GHz Tune and 5 loose sample pieces