

RFMD Green, RoHS Compliant, Pb-Free
Package: QFN, 2x2

Product Description

The SGL-0622Z is a low noise, high gain MMIC LNA designed for low power single-supply operation from 2.7V to 3.6V. Its Class-1C ESD protection and high input overdrive capability ensures rugged performance, while its integrated active bias circuit maintains robust stable bias over temperature and process beta variation. The SGL-0622Z is internally matched from 5MHz to 4000 MHz and requires only 4 to 5 external biasing components (DC blocks, bypass caps, inductive choke). The SGL-0622Z is fabricated using highly repeatable Silicon Germanium technology and is housed in a cost-effective RoHS/WEEE compliant QFN 2x2 miniature package.

Optimum Technology Matching® Applied

- GaAs HBT
- GaAs MESFET
- InGaP HBT
- SiGe BiCMOS
- Si BiCMOS
- SiGe HBT
- GaAs pHEMT
- Si CMOS
- Si BJT
- GaN HEMT
- RF MEMS

Typical Performance

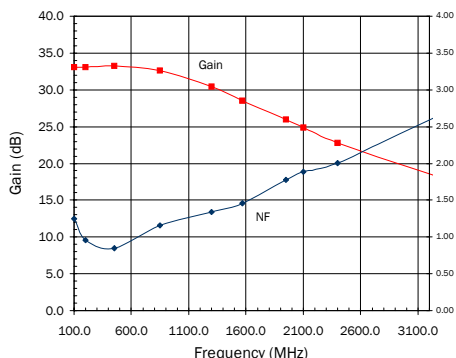

Features

- High Gain = 28dB at 1575 MHz
- Low Noise Figure = 1.5dB at 1575 MHz
- Low Power Consumption, 10.5 mA @ 3.3V
- Battery Operation: 2.7V to 3.6V (Active Biased)
- Fully Integrated Matching
- Class-1C ESD Protection (>1000V HBM)
- High input overdrive capability, +18dBm

Applications

- High Gain GPS Receivers
- ISM and WiMAX LNAs

Parameter	Specification			Unit	Condition
	Min.	Typ.	Max.		
Small Signal Gain	25.0	28.0	31.0	dB	1.575GHz
		23.0		dB	2.44GHz
		14.5	16.5	18.5	dB
Output Power at 1dB Compression	3.3	5.3		dBm	1.575GHz
		1.5		dBm	2.44GHz
		-1.4		dBm	3.50GHz
Input Third Order Intercept Point	-16.0	-13.0		dBm	1.575GHz
		-12.0		dBm	2.44GHz
		-8.5		dBm	3.50GHz
Input Return Loss	12.0	14.0		dB	1.575GHz
		12.0		dB	2.44GHz
		10.0		dB	3.50GHz
Output Return Loss	6.0	9.5		dB	1.575GHz
		14.0		dB	2.44GHz
		22.0		dB	3.50GHz
Noise Figure		1.5	1.9	dB	1.575GHz
		2.0		dB	2.44GHz
		2.8		dB	3.50GHz
Reverse Isolation		-28.0		dB	0.05GHz to 4.0GHz
Thermal Resistance		150		°C/W	junction - lead
Device Operating Current	7.5	10.5	12.5	mA	

Test Conditions: V_{CC}=3.3V, I_D=10.5mA Typ., IIP₃ Tone Spacing=1MHz, P_{OUT} per tone=-15dBm, T_L=25°C, Z_S=Z_L=50Ω

Absolute Maximum Ratings

Parameter	Rating	Unit
Device Current (I_D)	20	mA
Device Voltage (V_D)	4	V
RF Input Power* (See Note)	18	dBm
Junction Temp (T_J)	+150	°C
Operating Temp Range (T_L)	-40 to +85	°C
Storage Temp	+150	°C
ESD Rating - Human Body Model (HBM)	Class 1C	
Moisture Sensitivity Level	MSL 1	



Caution! ESD sensitive device.

Exceeding any one or a combination of the Absolute Maximum Rating conditions may cause permanent damage to the device. Extended application of Absolute Maximum Rating conditions to the device may reduce device reliability. Specified typical performance or functional operation of the device under Absolute Maximum Rating conditions is not implied.

RoHS status based on EU Directive 2002/95/EC (at time of this document revision).

The information in this publication is believed to be accurate and reliable. However, no responsibility is assumed by RF Micro Devices, Inc. ("RFMD") for its use, nor for any infringement of patents, or other rights of third parties, resulting from its use. No license is granted by implication or otherwise under any patent or patent rights of RFMD. RFMD reserves the right to change component circuitry, recommended application circuitry and specifications at any time without prior notice.

*Note: Load condition1, $Z_L = 50\Omega$. Load condition2, $Z_L = 10:1$ VSWR.

Operation of this device beyond any one of these limits may cause permanent damage. For reliable continuous operation, the device voltage and current must not exceed the maximum operating values specified in the table on page one.

Bias Conditions should also satisfy the following expression:

$$I_D V_D < (T_J - T_L) / R_{TH} + j - I \text{ and } T_L = T_{LEAD}$$

Typical RF Performance at Key Operating Frequencies (With Application Circuit)

Parameter	Unit	100 MHz	200 MHz	450 MHz	850 MHz	1575 MHz	1950 MHz	2440 MHz	3550 MHz
Small Signal Gain, S21	dB	34.6	34.9	34.4	32.8	28.5	26.1	23.0	17.0
Input Third Order Intercept Point, IIP3	dBm					-13.0		-12.0	-8.5
Output at 1dB Compression, P1dB	dBm	2.7				5.3		1.5	-1.4
Input Return Loss	dB	15.1	20.0	12.6	16.0	14.3	12.8	12.0	10.0
Output Return Loss	dB	9.2	12.2	11.8	10.4	9.5	12.1	14.0	22.0
Reverse Isolation	dB	38.8	39.8	38.7	39.9	35.6	34.8	32.0	29.0
Noise Figure, NF	dB	1.25	0.96	0.84	1.16	1.50	1.78	2.01	2.81

Test Conditions: $V_{CC} = 3.3V$ $I_D = 10.5mA$ Typ. IIP3 Tone Spacing = 1MHz, P_{OUT} per tone = -15dBm
 $T_L = 25^\circ C$ $Z_S = Z_L = 50\Omega$

Noise Figure versus Frequency

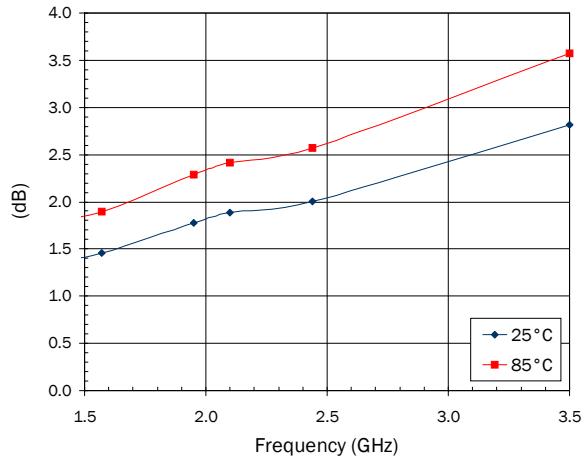

IIP₃ versus Frequency

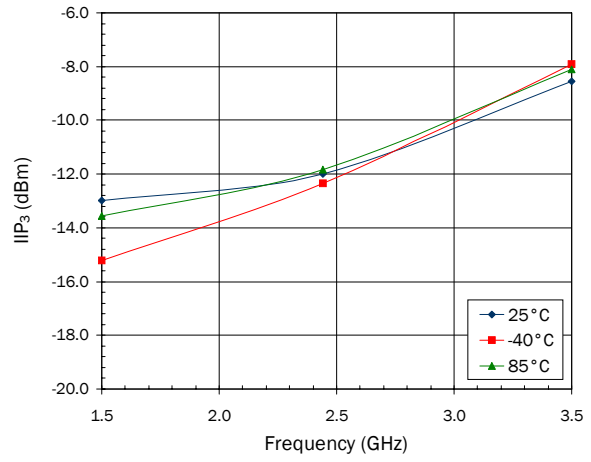

P_{1dB} versus Frequency

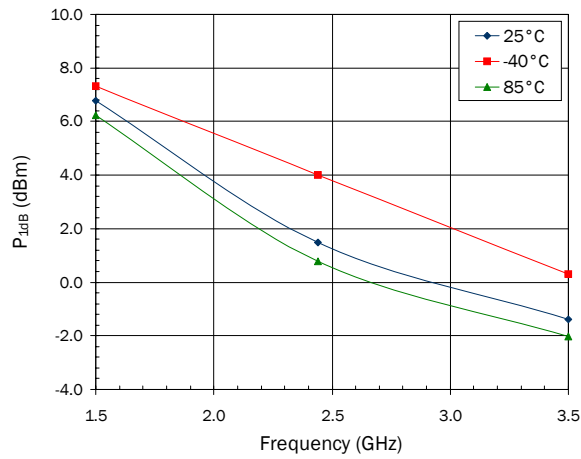

Application Circuit Data, $V_{CC}= 3.3V$, $I_D= 9mA$

IM3 versus Frequency

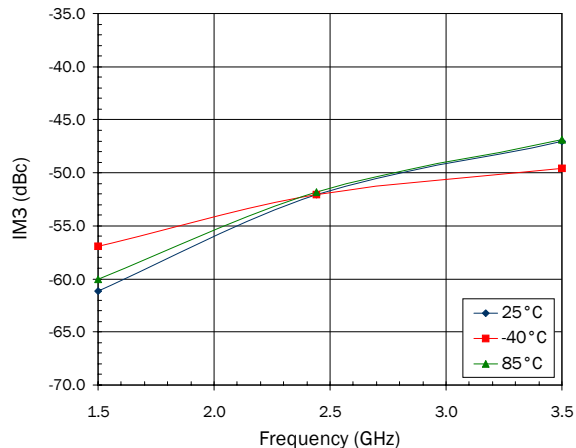

DCIV over Temperature

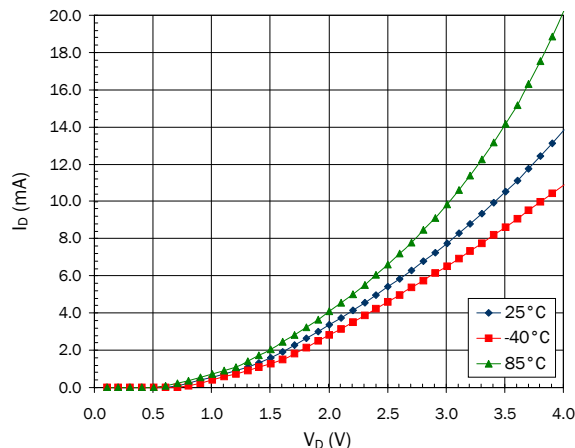

S22 versus Frequency

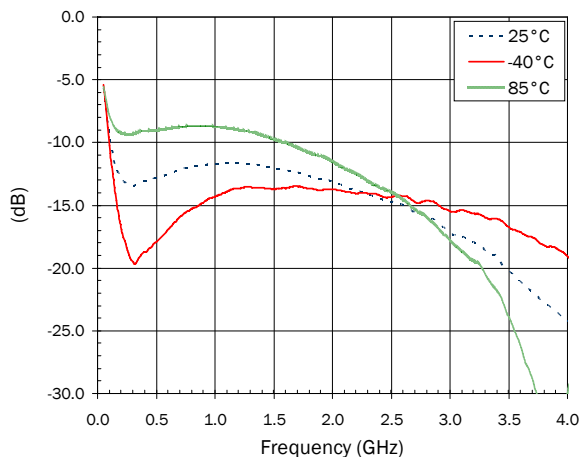

S21 versus Frequency

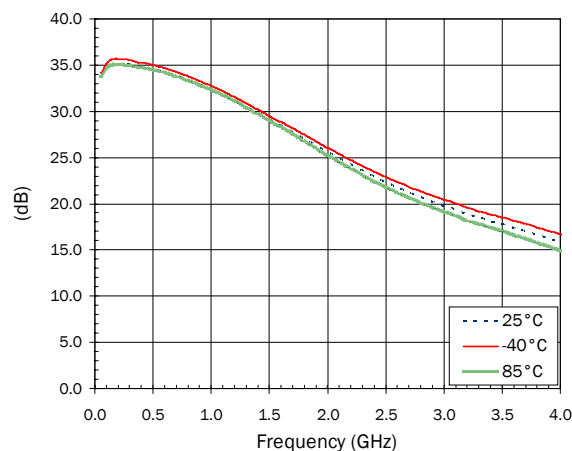

S12 versus Frequency

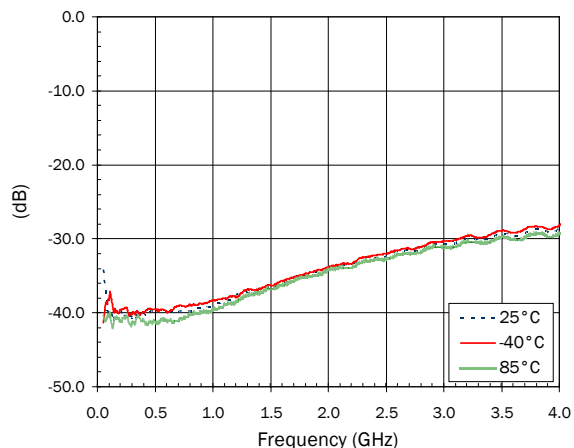

S22 versus Frequency

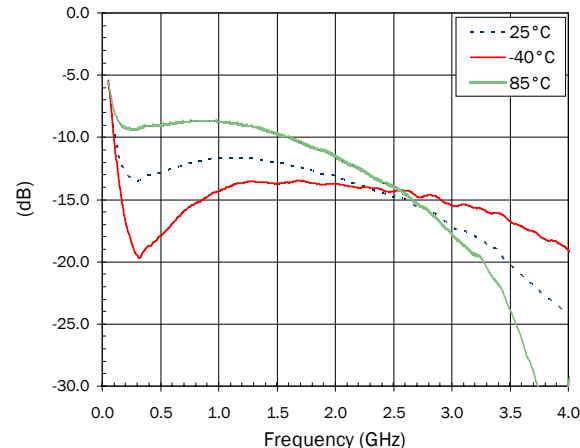

Pin	Function	Description
1	RF OUT/VD	RF output and bias pin. Bias should be supplied to this pin through an external RF choke. (See application circuit)
2	GND	Connect to ground per application circuit drawing.
3, 5, 6, 7, 8	N/A	Not Used
4	RF IN	RF input pin. This pin requires the use of an external DC blocking capacitor as shown in the application schematics.
EPAD	GND	Exposed area on the bottom side of the package needs to be soldered to the ground plane of the board for thermal and RF performance. Vias should be located under the EPAD as shown in the recommended land pattern.

Suggested Pad Layout

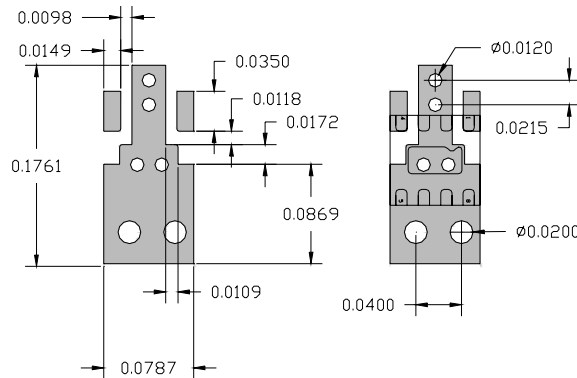

Nominal Package Dimensions

Dimensions in inches (millimeters)

Refer to drawing posted at www.rfmd.com for tolerances.

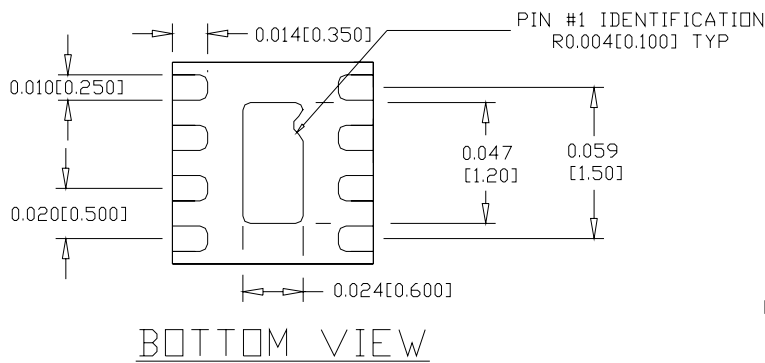

Package Type:
2 x 2 QFN

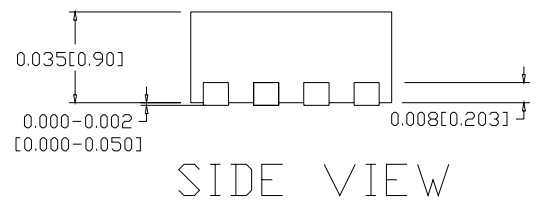

Part Identification

Pin 1 Dot
By Marking

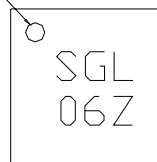

Application Schematic

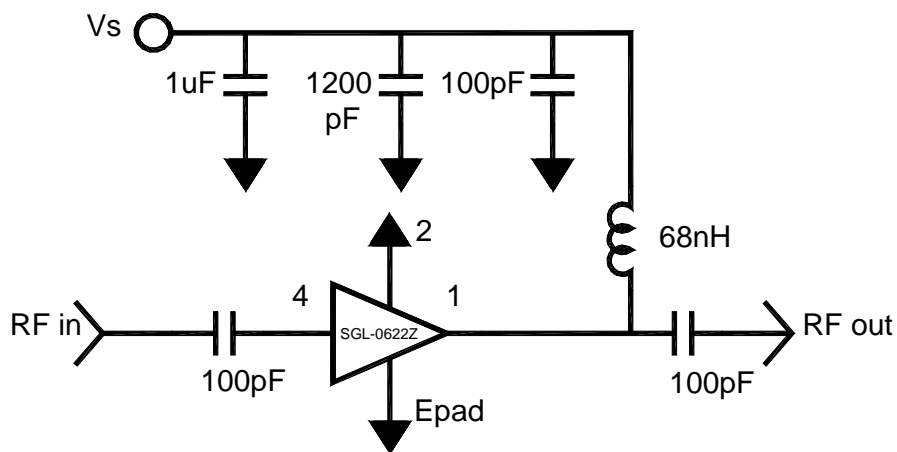

Evaluation Board Layout and Bill of Materials

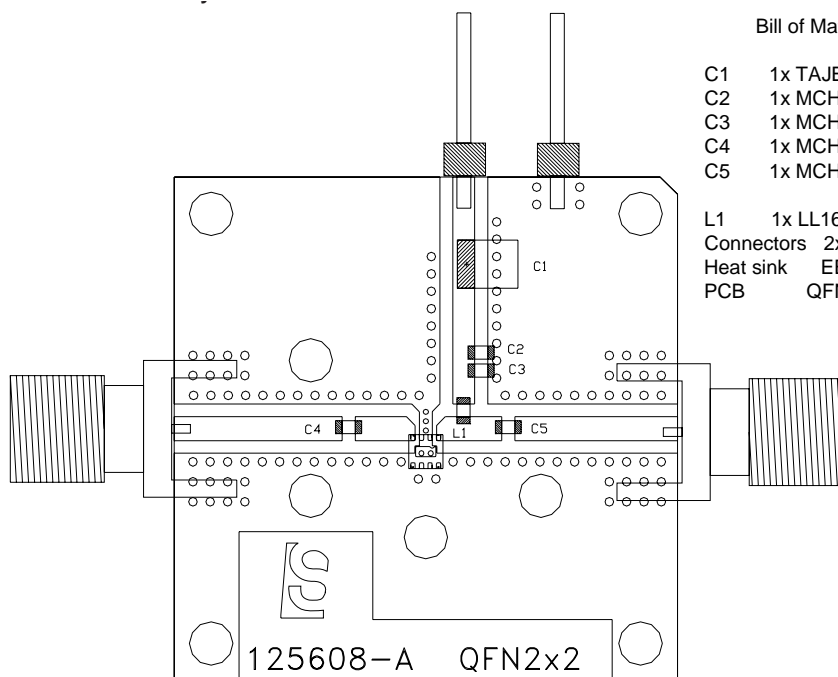

Bill of Materials

- C1 1x TAJB105KLRH Rohm 1.0uF
- C2 1x MCH185C122KK Rohm 1200pF
- C3 1x MCH185A101JK Rohm 100pF
- C4 1x MCH185A101JK Rohm 100pF
- C5 1x MCH185A101JK Rohm 100pF
- L1 1x LL1608-FS56NJ Toko 68nH
- Connectors 2x PSF-S01-1mm GigaLane Co.
- Heat sink EEF-102059
- PCB QFN2x2

Ordering Information

Part Number	Description	Reel Size	Devices/Reel
SGL-0622Z	Lead Free, RoHS Compliant	7"	3000
SGL-0622Z-EVB1	100-3500MHz	N/A	N/A