



RFMD Green, RoHS Compliant, Pb-Free (Z Part Number)
Package: SOT-86

Product Description

The SGA-6286 is a high performance SiGe HBT MMIC Amplifier. A Darlington configuration featuring one-micron emitters provides high F_T and excellent thermal performance. The heterojunction increases breakdown voltage and minimizes leakage current between junctions. Cancellation of emitter junction non-linearities results in higher suppression of intermodulation products. Only two DC-blocking capacitors, a bias resistor, and an optional RF choke are required for operation.

Features

- Broadband Operation: DC to 5500MHz
- Cascadable 50Ω
- Operates from Single Supply
- Low Thermal Resistance Package

Applications

- PA Driver Amplifier
- Cellular, PCS, GSM, UMTS
- IF Amplifier
- Wireless Data, Satellite

Optimum Technology Matching® Applied

- GaAs HBT
- GaAs MESFET
- InGaP HBT
- SiGe BiCMOS
- Si BiCMOS
- SiGe HBT
- GaAs pHEMT
- Si CMOS
- Si BJT
- GaN HEMT
- RF MEMS

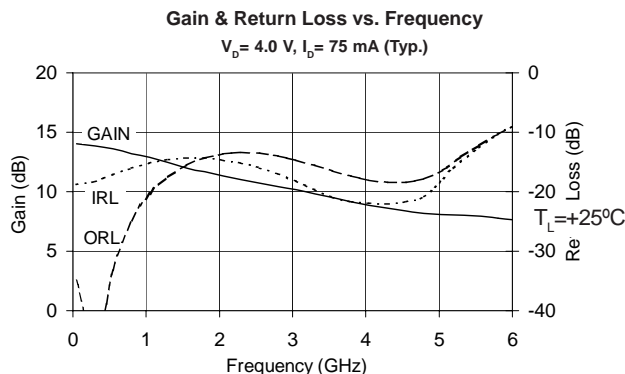

Parameter	Specification			Unit	Condition
	Min.	Typ.	Max.		
Small Signal Gain	12.5	13.6	15.2	dB	850MHz
		12.4		dB	1950MHz
		11.2		dB	2400MHz
Output Power at 1dB Compression		18.7		dBm	850MHz
		17.8		dBm	1950MHz
Output Third Intercept Point		35.0		dBm	850MHz
		33.0		dBm	1950MHz
Bandwidth Determined by Return Loss		5500		MHz	>10dB
Input Return Loss		14.6		dB	1950MHz
Output Return Loss		13.9		dB	1950MHz
Noise Figure		4.2		dB	1950MHz
Device Operating Voltage	3.6	4.0	4.4	V	
Device Operating Current	67	75	83	mA	
Thermal Resistance (Junction - Lead)		97		°C/W	

Test Conditions: $V_S=8V$, $I_D=75\text{ mA Typ.}$, OIP_3 Tone Spacing = 1MHz, P_{OUT} per tone = 0dBm, $R_{BIAS}=51\Omega$, $T_L=25^\circ\text{C}$, $Z_S=Z_L=50\Omega$

Absolute Maximum Ratings

Parameter	Rating	Unit
Max Device Current (I_D)	150	mA
Max Device Voltage (V_D)	6	V
Max RF Input Power	+18	dBm
Max Junction Temp (T_J)	+150	°C
Operating Temp Range (T_L)	-40 to +85	°C
Max Storage Temp	+150	°C



Caution! ESD sensitive device.

Exceeding any one or a combination of the Absolute Maximum Rating conditions may cause permanent damage to the device. Extended application of Absolute Maximum Rating conditions to the device may reduce device reliability. Specified typical performance or functional operation of the device under Absolute Maximum Rating conditions is not implied.

RoHS status based on EU Directive 2002/95/EC (at time of this document revision).

The information in this publication is believed to be accurate and reliable. However, no responsibility is assumed by RF Micro Devices, Inc. ("RFMD") for its use, nor for any infringement of patents, or other rights of third parties, resulting from its use. No license is granted by implication or otherwise under any patent or patent rights of RFMD. RFMD reserves the right to change component circuitry, recommended application circuitry and specifications at any time without prior notice.

Operation of this device beyond any one of these limits may cause permanent damage. For reliable continuous operation, the device voltage and current must not exceed the maximum operating values specified in the table on page one.

Bias Conditions should also satisfy the following expression:

$$I_D V_D < (T_J - T_L) / R_{TH, J-I}$$

Typical Performance at Key Operating Frequencies

Parameter	Unit	100 MHz	500 MHz	850 MHz	1950 MHz	2400 MHz	3500 MHz
Small Signal Gain	dB	14.0	13.9	13.6	12.4	11.2	9.6
Output Third Order Intercept Point	dBm	37.0	36.0	35.0	33.0	31.4	28.1
Output Power at 1dB Compression	dBm	18.7	19.0	18.7	17.8	16.8	15.2
Input Return Loss	dB	18.8	17.4	15.8	14.6	15.5	20.6
Output Return Loss	dB	35.7	36.3	23.8	13.9	13.4	16.4
Reverse Isolation	dB	18.4	18.6	18.8	18.8	18.5	17.0
Noise Figure	dB	4.0	3.9	3.9	4.2	4.4	4.8

Test Conditions: $V_S=8V$, $I_D=75\text{ mA Typ.}$, OIP_3 Tone Spacing=1MHz, P_{OUT} per tone=0dBm, $R_{BIAS}=51\Omega$, $T_L=25^\circ\text{C}$, $Z_S=Z_L=50\Omega$

OIP_3 vs. Frequency
 $V_D=4.0\text{ V}$, $I_D=75\text{ mA}$

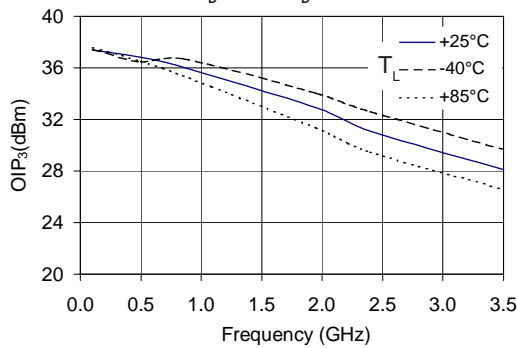

P_{1dB} vs. Frequency
 $V_D=4.0\text{ V}$, $I_D=75\text{ mA}$

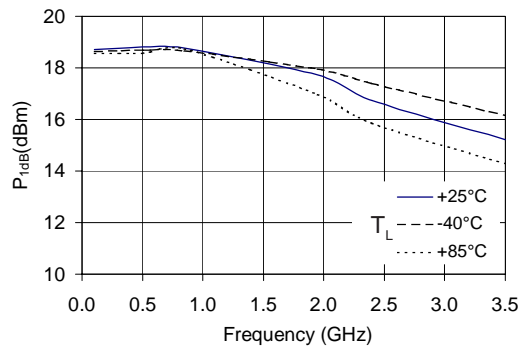

Noise Figure vs. Frequency
 $V_D=4.0\text{ V}$, $I_D=75\text{ mA}$

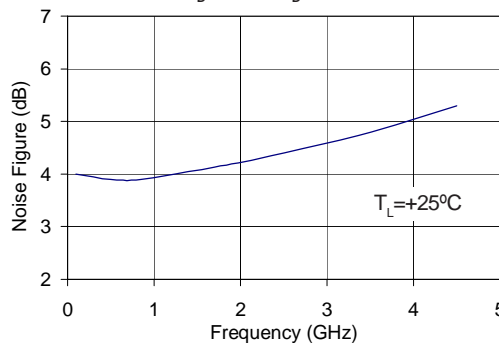

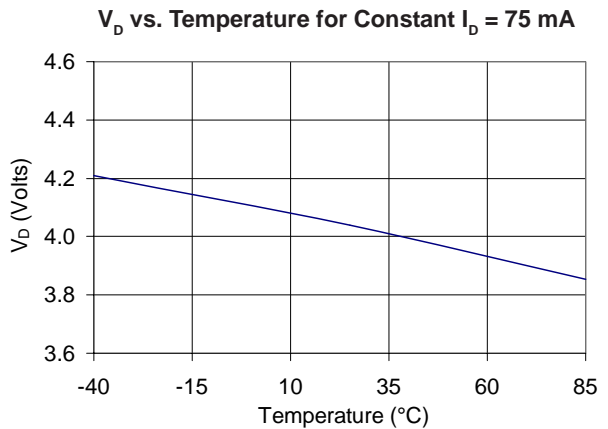
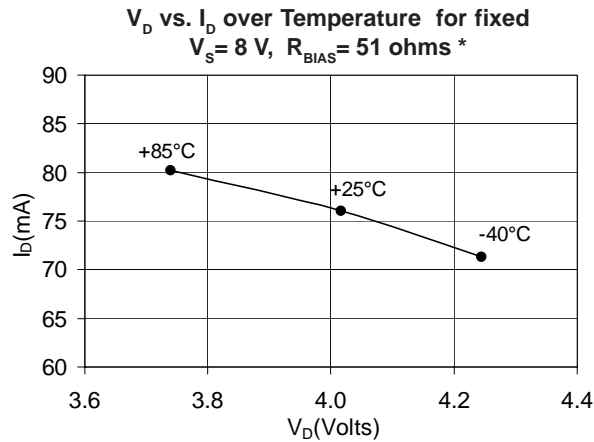
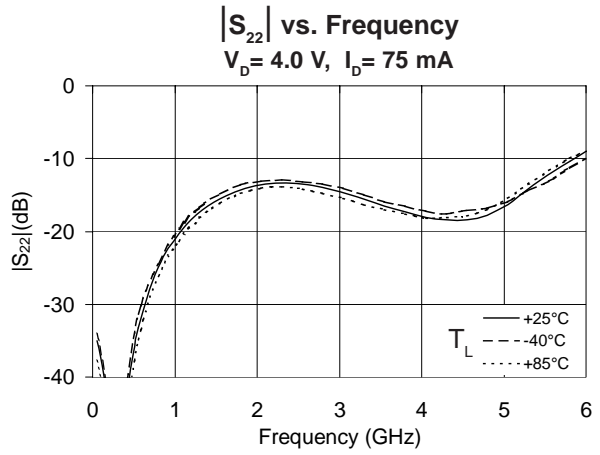
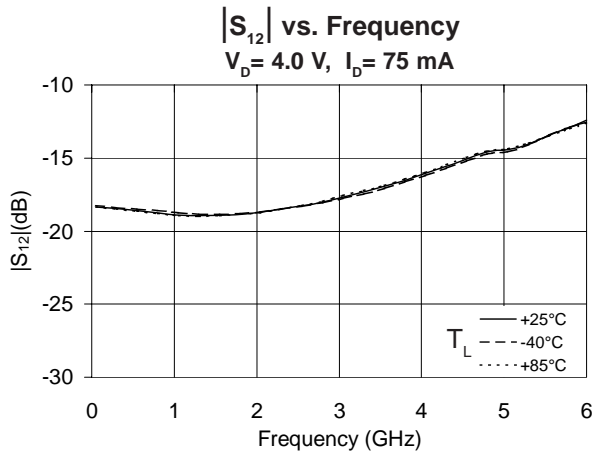
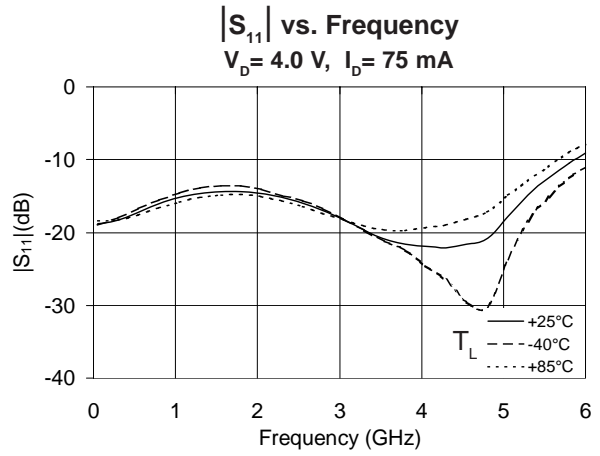
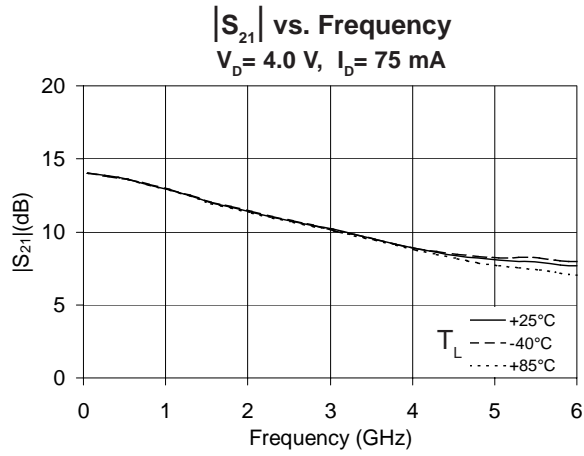

* Note: In the applications circuit on page 4, R_{BIAS} compensates for voltage and current variation over temperature.

Pin	Function	Description
1	RF IN	RF input pin. This pin requires the use of an external DC-blocking capacitor chosen for the frequency of operation.
2, 4	GND	Connection to ground. For optimum RF performance, use via holes as close to ground leads as possible to reduce lead inductance.
3	RF OUT/BIAS	RF output and bias pin. DC voltage is present on this pin, therefore a DC-blocking capacitor is necessary for proper operation.

Application Schematic

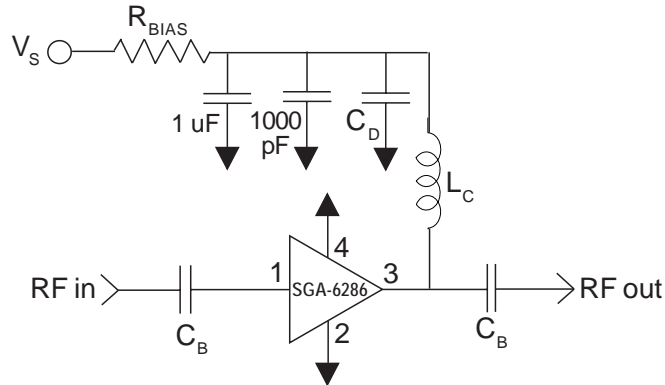

Reference Designator	Frequency (Mhz)				
	500	850	1950	2400	3500
C _B	220 pF	100 pF	68 pF	56 pF	39 pF
C _D	100 pF	68 pF	22 pF	22 pF	15 pF
L _C	68 nH	33 nH	22 nH	18 nH	15 nH

Recommended Bias Resistor Values for I _D =75mA				
$R_{BIAS} = (V_S - V_D) / I_D$				
Supply Voltage(V _S)	6 V	8 V	10 V	12 V
R _{BIAS}	27 Ω	51 Ω	82 Ω	110 Ω

Note: R_{BIAS} provides DC bias stability over temperature.

Evaluation Board Layout

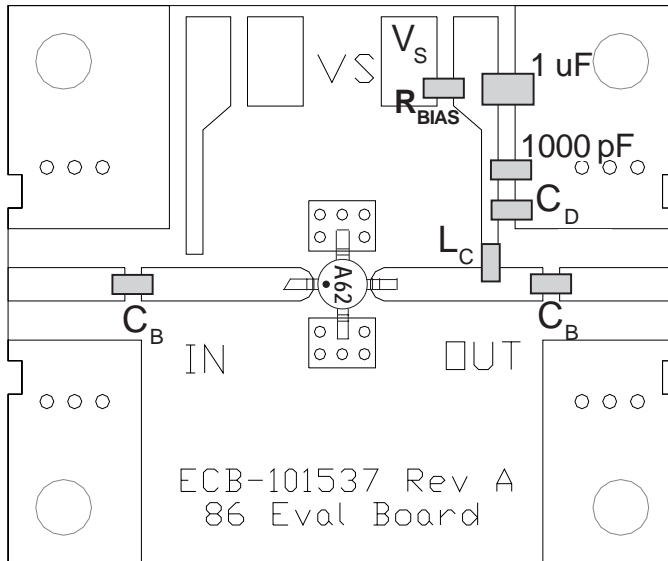

Mounting Instructions

1. Use a large ground pad area under device pins 2 and 4 with many plated through-holes as shown.
2. We recommend 1 or 2 ounce copper. Measurements for this data sheet were made on a 31 mil thick FR-4 board with 1 ounce copper on both sides.

Suggested Pad Layout

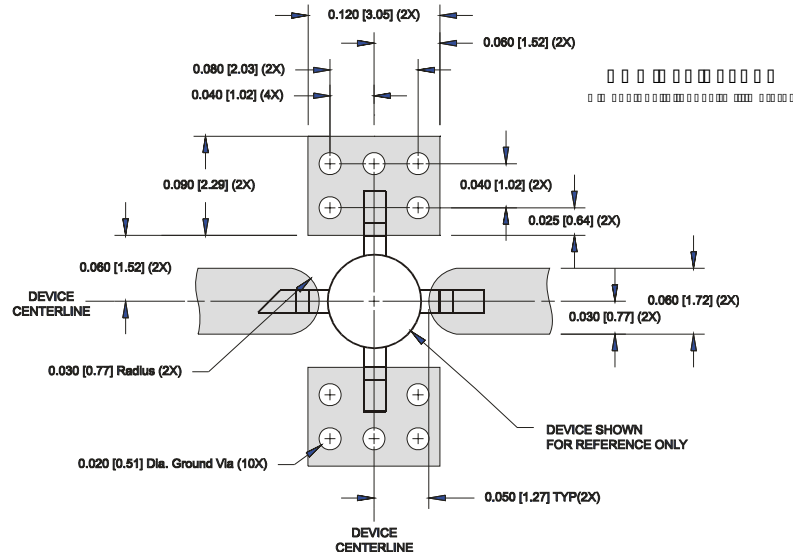

Package Drawing

Dimensions in inches (millimeters)
Refer to drawing posted at www.rfmd.com for tolerances.

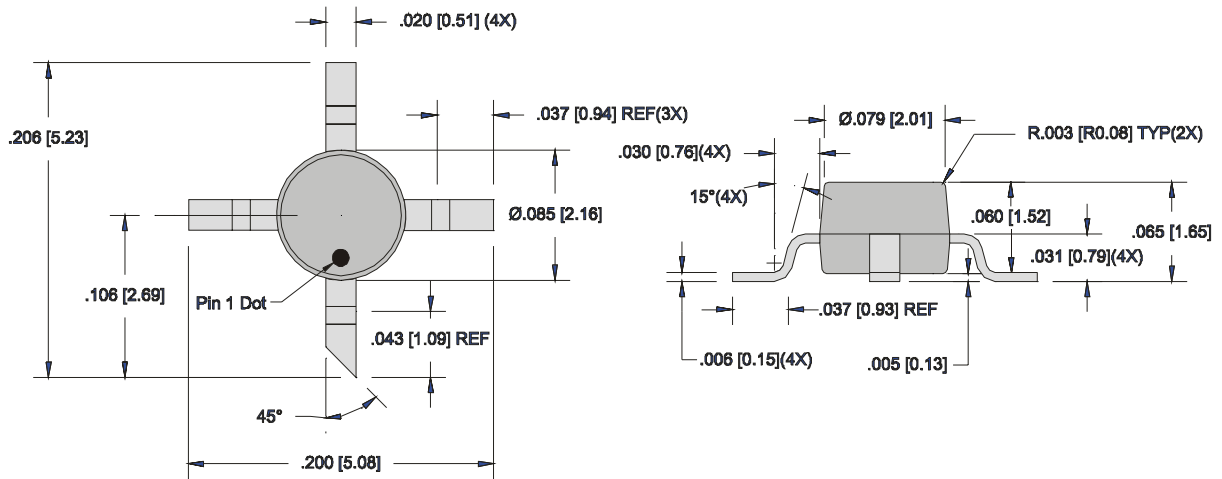

Part Identification

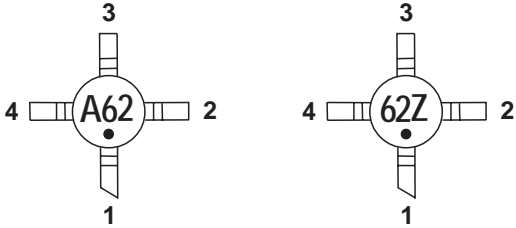

Ordering Information

Part Number	Reel Size	Devices/Reel
SGA-6286	13"	3000
SGA-6286Z	13"	3000