



Package: SOT-89



### Product Description

RFMD's SBF-5089(Z) is a high performance InGaP/GaAs Heterojunction Bipolar Transistor MMIC Amplifier. A Darlington configuration designed with InGaP process technology provides broadband performance up to 0.5GHz with excellent thermal performance. The heterojunction increases breakdown voltage and minimizes leakage current between junctions. Cancellation of emitter junction non-linearities results in higher suppression of intermodulation products. Only a single positive supply voltage, DC-blocking capacitors, a bias resistor, and an optional RF choke are required for operation.

#### Optimum Technology Matching® Applied

- GaAs HBT
- GaAs MESFET
- InGaP HBT
- SiGe BiCMOS
- Si BiCMOS
- SiGe HBT
- GaAs pHEMT
- Si CMOS
- Si BJT
- GaN HEMT
- InP HBT
- RF MEMS
- LDMOS

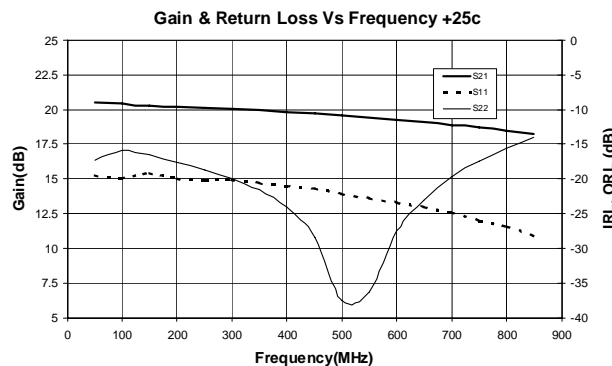

### Features

- Available in RoHS Compliant and Pb-Free (Z Part Number)
- $IP_3 = 41$  dBm at 240MHz
- Stable Gain Over Temperature
- Robust 1000V ESD, Class 1C
- Operates From Single Supply
- Low Thermal Resistance

### Applications

- Receiver IF Applications
- Cellular, PCS, GSM, UMTS
- IF Amplifier
- Wireless Data, Satellite Terminals

Parameter	Specification			Unit	Condition
	Min.	Typ.	Max.		
Small Signal Gain		20.5		dB	70MHz
	18.5	20.0	21.5	dB	240MHz
	18.0	19.5	21.0	dB	500MHz
Output Power at 1dB Compression		21		dBm	70MHz
		21		dBm	240MHz
	19.2	20.7		dBm	400MHz
Output Third Order Intercept Point		39.0		dBm	70MHz
		41.0		dBm	240MHz
	37.5	39.5		dBm	400MHz
Input Return Loss	14	18		dB	500MHz
Output Return Loss	12.0	16.0		dB	500MHz
Noise Figure		2.8	3.8	dB	500MHz
Device Operating Voltage	4.5	4.9	5.3	V	
Device Operating Current	82	90	98	mA	
Thermal Resistance		43		°C/W	junction to lead

Test Conditions:  $V_S = 8V$ ,  $I_D = 90mA$  Typ.,  $T_L = 25^\circ C$ .  $OIP_3$  Tone Spacing = 1MHz,  $P_{OUT}$  per tone = 0dBm,  $R_{BIAS} = 33\Omega$ . Data with Application Circuit.

## Absolute Maximum Ratings

Parameter	Rating	Unit
Device Current ( $I_D$ )	150	mA
Device Voltage ( $V_D$ )	6	V
RF Input Power	+19	dBm
Max Operating Dissipated Power	0.8	W
Junction Temp ( $T_J$ )	+150	°C
Operating Temp Range ( $T_L$ )	-40 to +85	°C
Storage Temp	+150	°C
ESD Rating - Human Body Model (HBM)	Class 1C	
Moisture Sensitivity Level	MSL 2	



**Caution!** ESD sensitive device.

Exceeding any one or a combination of the Absolute Maximum Rating conditions may cause permanent damage to the device. Extended application of Absolute Maximum Rating conditions to the device may reduce device reliability. Specified typical performance or functional operation of the device under Absolute Maximum Rating conditions is not implied.

RoHS status based on EU Directive 2002/95/EC (at time of this document revision).

The information in this publication is believed to be accurate and reliable. However, no responsibility is assumed by RF Micro Devices, Inc. ("RFMD") for its use, nor for any infringement of patents, or other rights of third parties, resulting from its use. No license is granted by implication or otherwise under any patent or patent rights of RFMD. RFMD reserves the right to change component circuitry, recommended application circuitry and specifications at any time without prior notice.

Operation of this device beyond any one of these limits may cause permanent damage. For reliable continuous operation, the device voltage and current must not exceed the maximum operating values specified in the table on page one.

Bias Conditions should also satisfy the following expression:

$$I_D V_D < (T_J - T_L) / R_{TH, J-I} \text{ and } T_L = T_{LEAD}$$

## Typical RF Performance at Key Operating Frequencies

Parameter	Unit	70MHz	100MHz	240MHz	400MHz	500MHz	850MHz
Small Signal Gain	dB	20.5	20.4	20.1	19.8	19.5	18.2
Output Third Order Intercept Point	dBm	39	39	41	39.5	39	34
Output Power at 1dB Compression	dBm	21.0	21.0	21.0	20.7	20.8	18.6
Input Return Loss	dB	19.4	19.9	20.1	20.9	22.0	26.8
Output Return Loss	dB	17.2	15.8	18.6	24.0	37.5	15.5
Reverse Isolation	dB	25.2	22.4	22.3	22.3	22.3	22.4
Noise Figure	dB	2.7	2.8	2.7	2.8	2.8	2.8

Test Conditions:  $V_S = 8V$ ,  $I_D = 90mA$  Typ., OIP<sub>3</sub> Tone Spacing = 1MHz, P<sub>OUT</sub> per tone = 0dBm.  $T_L = 25^\circ C$ , R<sub>BIAS</sub> = 33Ω, Z<sub>S</sub> = Z<sub>L</sub> = 50Ω, App circuit.

**P1dB vs Temp**

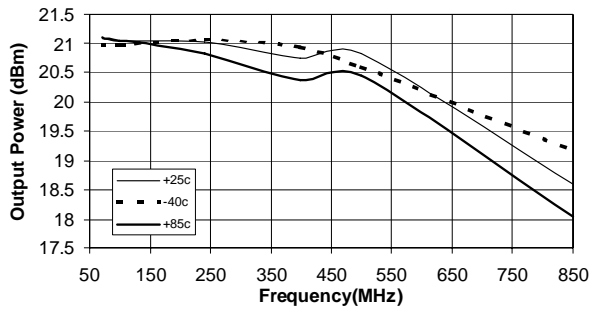

**TOIP vs Temp**

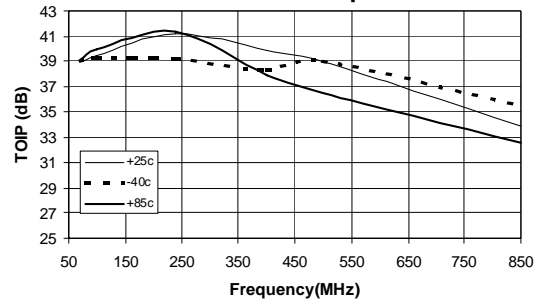

**Noise Figure vs Temp**

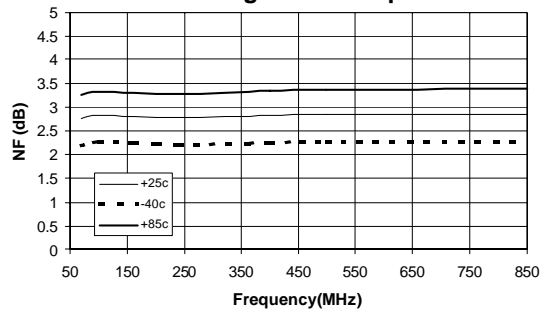

# SBF-5089(Z)



rfmd.com

Test Conditions:  $V_S=8V$ ,  $R_{BIAS}=33\Omega$ ,  $I_D=90mA$ ,  $T=+25^\circ C$ ,

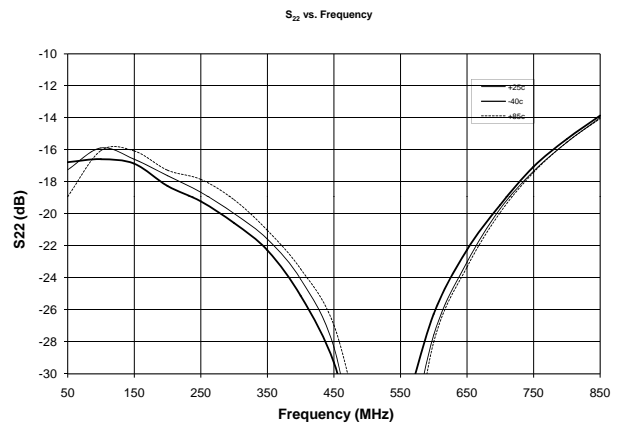
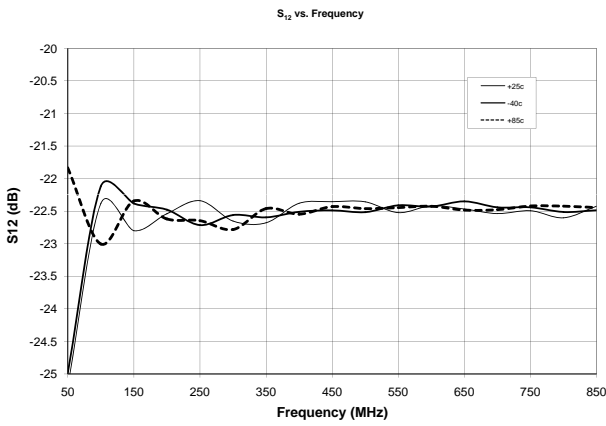
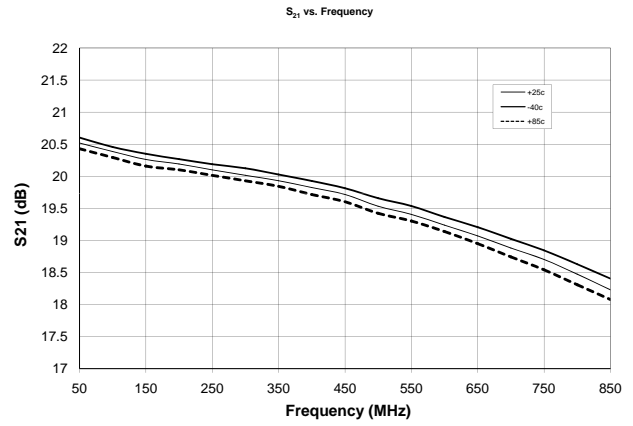
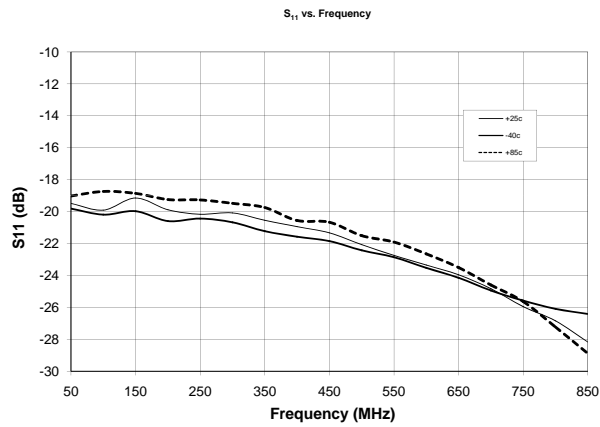

## Bias Sweep vs. Temperature

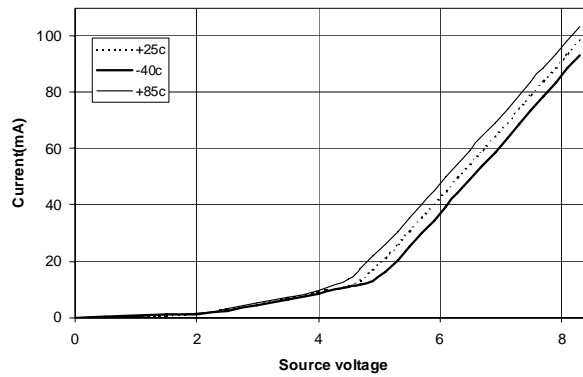

Note: Output Return Loss can be improved at low end of band with L1 selection.

**Application Circuit Schematic**

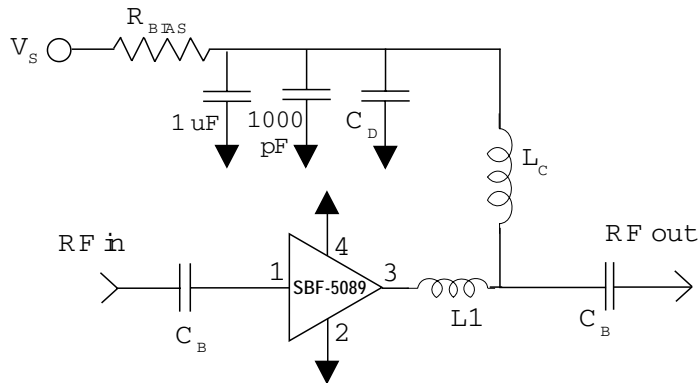

**Application Circuit Element Values**

Reference Designator	70MHz	100MHz	240MHz	500MHz	850MHz
C <sub>B</sub>	1uF	1000pF	1000pF	220pF	100pF
C <sub>D</sub>	1uF	100pF	100pF	100pF	68pF
L <sub>C</sub>	6.8uH	1.2uH	1.2uH	68nH	33nH
L1	6.8nH	6.8nH	6.8nH	6.8nH	6.8nH

**Recommended Bias Resistance for I<sub>D</sub>=90mA**

Supply Voltage (V <sub>S</sub> ) (Volts)	7.5	8	10	12
Bias Resistance (Ω)	27	33	55	77

Note = R<sub>BIAS</sub> provides DC bias stability over temperature.

## Evaluation Board Layout

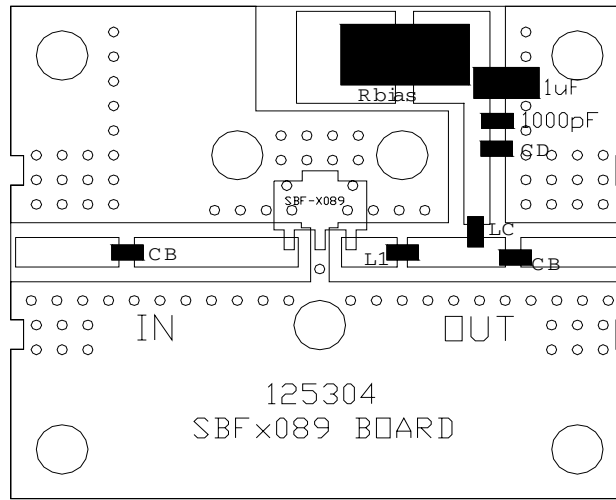

### Mounting Instructions

1. Note: For broadband RF unconditional stability do not put GND vias under the exposed backside GND paddle.
2. Solder the copper pad on the backside of the device package to the ground plane.
3. Use a large ground pad area with many plated through-holes as shown.
4. We recommend 1 or 2 ounce copper. Measurement for this data sheet were made on a 31mil thick FR-4 board with 1 ounce copper on both sides.

Pin	Function	Description
1	RF IN	RF input pin. This pin requires the use of an external DC-blocking capacitor chosen for the frequency of operation.
2, 4	GND	Connection to ground. Use via holes for best performance to reduce lead inductance as close to ground leads as possible.
3	RF OUT/BIAS	RF output and bias pin. DC voltage is present on this pin therefore a DC-blocking capacitor is necessary for proper operation.

**Suggested Pad Layout**

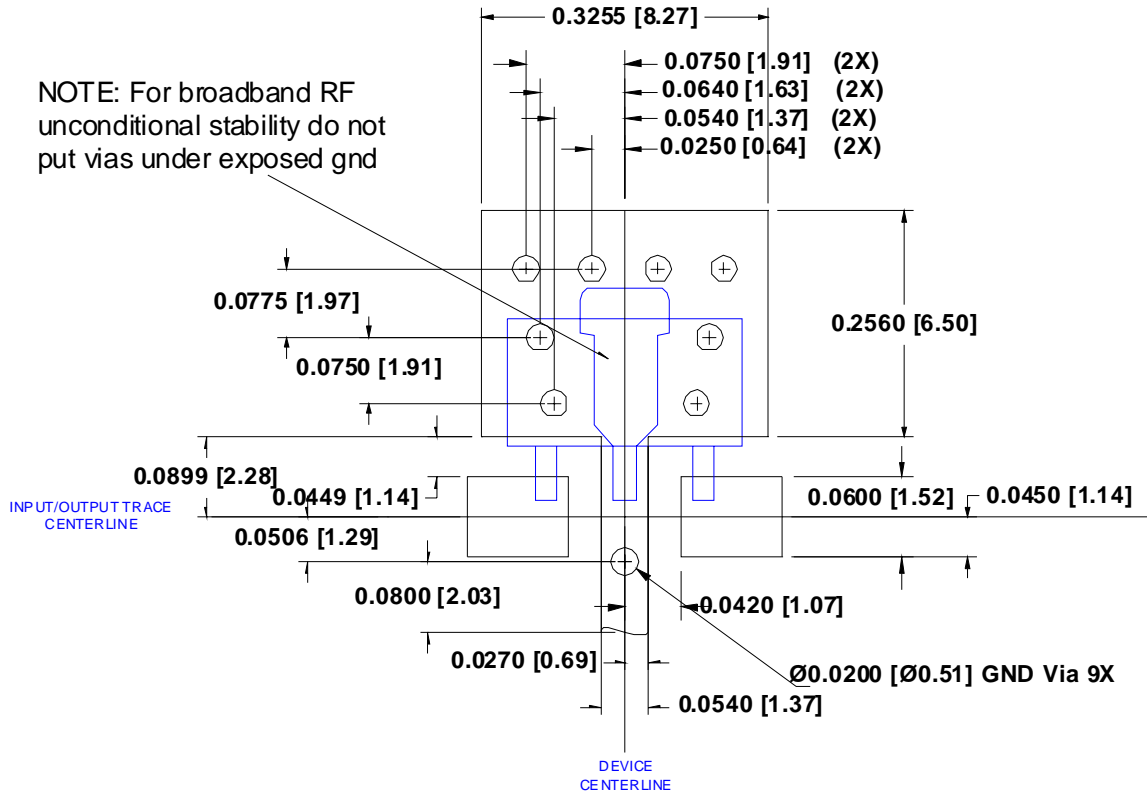

**Package Drawing**

Dimensions in inches (millimeters)

Refer to drawing posted at [www.rfmd.com](http://www.rfmd.com) for tolerances.

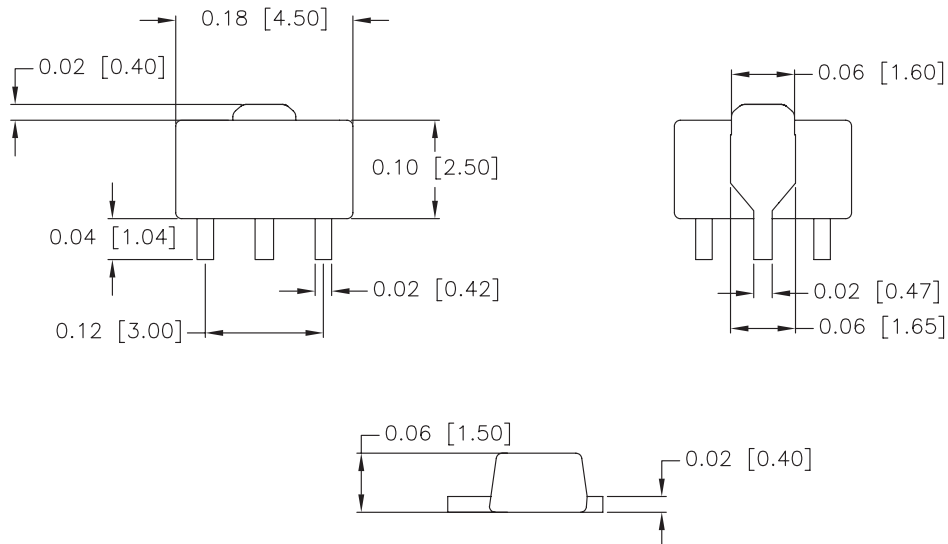

### Part Identification

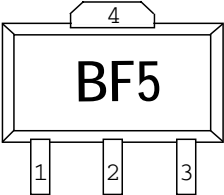

Tin-Lead

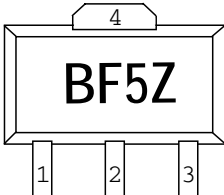

Lead Free

Alternate marking “SBF5089” or “SBF5089Z” on line one with Trace Code on line two.

### Ordering Information

Part Number	Reel Size	Devices/Reel
SBF-5089	7"	1000
SBF-5089Z	7"	1000