



### Product Description

RFMD's SBA4086Z is a high performance InGaP/GaAs Heterojunction Bipolar Transistor MMIC Amplifier. A Darlington configuration designed with InGaP process technology provides broadband performance up to 5GHz with excellent thermal performance. The heterojunction increases breakdown voltage and minimizes leakage current between junctions. Cancellation of emitter junction non-linearities results in higher suppression of intermodulation products. Only a single positive supply voltage, DC-blocking capacitors, a bias resistor, and an optional RF choke are required for operation.

**Optimum Technology Matching® Applied**

- GaAs HBT
- GaAs MESFET
- InGaP HBT
- SiGe BiCMOS
- Si BiCMOS
- SiGe HBT
- GaAs pHEMT
- Si CMOS
- Si BJT
- GaN HEMT
- InP HBT
- RF MEMS
- LDMOS

Gain and Return Loss vs Frequency

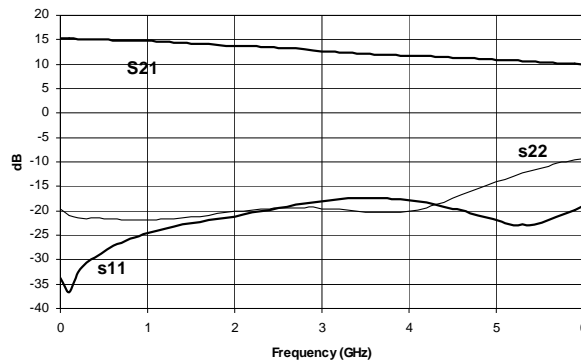

### Features

- IP<sub>3</sub> = 33.5 dBm at 1950 MHz
- P<sub>OUT</sub> = 12.3 dBm at -45 dBc ACP IS-95 1950 MHz
- Robust 1000V ESD, Class 1C
- Operates From Single Supply
- Patented Thermal Design

### Applications

- PA Driver Amplifier
- Cellular, PCS, GSM, UMTS
- IF Amplifier
- Wireless Data, Satellite Terminals

Parameter	Specification			Unit	Condition
	Min.	Typ.	Max.		
Small Signal Gain	13.3	14.8	16.3	dB	850 MHz
	12.7	14.2	15.7	dB	1950 MHz
Output Power at 1dB Compression	17.5	19.1		dBm	850 MHz
		19.0		dBm	1950 MHz
Output Third Order Intercept Point		36.5		dBm	850 MHz
	31.5	33.5		dBm	1950 MHz
Output Power		12.3		dBm	1950 MHz, -45 dBc ACP IS-95 9 Forward Channels
Bandwidth		5000		MHz	Return Loss > 10 dB
Input Return Loss	14.0	21.0		dB	1950 MHz
Output Return Loss	14.0	20.5		dB	1950 MHz
Noise Figure		4.8	5.8	dB	1950 MHz
Device Operating Voltage	4.6	5.0	5.4	V	
Device Operating Current	72	80	88	mA	
Thermal Resistance (junction to lead)		102		°C/W	

Test Conditions: V<sub>S</sub> = 8V, I<sub>D</sub> = 80 mA Typ., OIP<sub>3</sub> Tone Spacing = 1 MHz, P<sub>OUT</sub> per tone = 0 dBm, R<sub>BIAS</sub> = 39 Ω, T<sub>L</sub> = 25 °C, Z<sub>S</sub> = Z<sub>L</sub> = 50 Ω

## Absolute Maximum Ratings

Parameter	Rating	Unit
Device Current ( $I_D$ )	130	mA
Device Voltage ( $V_D$ )	6	V
RF Input Power	+17	dBm
Junction Temp ( $T_J$ )	+150	°C
Operating Temp Range ( $T_L$ )	-40 to +85	°C
Storage Temp	+150	°C
Operating Dissipated Power	0.65	W

Operation of this device beyond any one of these limits may cause permanent damage. For reliable continuous operation, the device voltage and current must not exceed the maximum operating values specified in the table on page one.

Bias Conditions should also satisfy the following expression:

$$I_D V_D < (T_J - T_L) / R_{TH, j-l} \text{ and } T_L = T_{LEAD}$$



**Caution!** ESD sensitive device.

Exceeding any one or a combination of the Absolute Maximum Rating conditions may cause permanent damage to the device. Extended application of Absolute Maximum Rating conditions to the device may reduce device reliability. Specified typical performance or functional operation of the device under Absolute Maximum Rating conditions is not implied.

The information in this publication is believed to be accurate and reliable. However, no responsibility is assumed by RF Micro Devices, Inc. ("RFMD") for its use, nor for any infringement of patents, or other rights of third parties, resulting from its use. No license is granted by implication or otherwise under any patent or patent rights of RFMD. RFMD reserves the right to change component circuitry, recommended application circuitry and specifications at any time without prior notice.



RFMD Green: RoHS compliant per EU Directive 2002/95/EC, halogen free per IEC 61249-2-21, < 1000ppm each of antimony trioxide in polymeric materials and red phosphorus as a flame retardant, and <2% antimony in solder.

## Typical Performance at Key Operating Frequencies

Parameter	Unit	100MHz	500MHz	850MHz	1950MHz	2400MHz	3500MHz
Small Signal Gain	dB	15.2	15.0	14.8	14.2	12.4	12.1
Output Third Order Intercept Point	dBm	37.1	36.3	36.5	33.5	32.7	29.7
Output Power at 1dB Compression	dBm	19.0	19.1	19.1	19.0	18.3	16.4
Input Return Loss	dB	36	28	25	21	19.7	17
Output Return Loss	dB	21	21	21.0	20.5	19.6	20.2
Reverse Isolation	dB	18	18	18	18	19	20
Noise Figure	dB	4.7	4.7	4.6	4.8	4.9	5.0

Test Conditions:  $V_S = 8V$ ,  $I_D = 80mA$  Typ.,  $OIP_3$  Tone Spacing = 1MHz,  $P_{OUT}$  per tone = 0dBm,  $R_{BIAS} = 39\Omega$ ,  $T_L = 25^\circ C$ ,  $Z_S = Z_L = 50\Omega$

NF vs Frequency

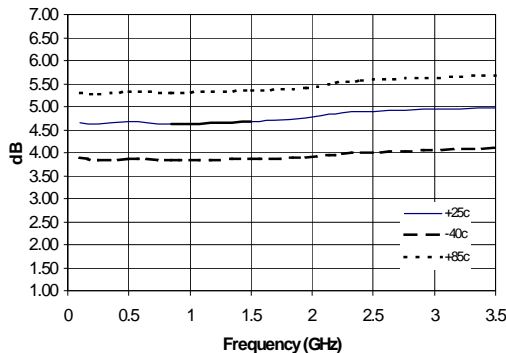

P1dB vs Frequency

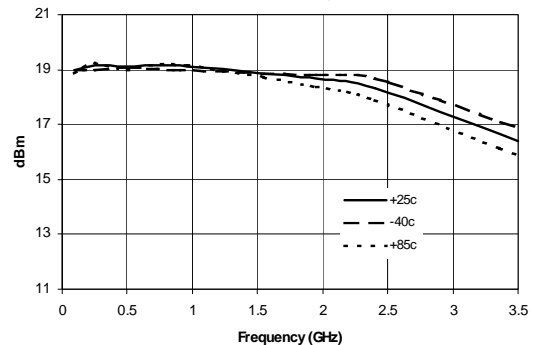

IP3 vs Frequency

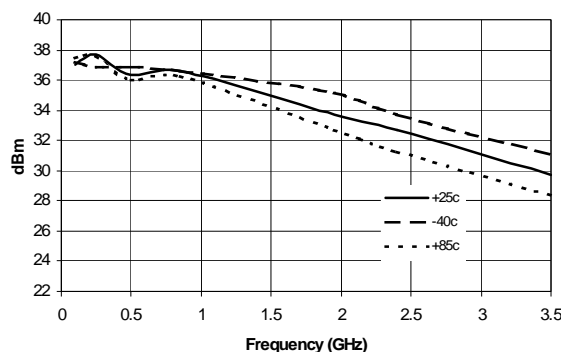

**$|S_{11}|$  vs. Frequency**

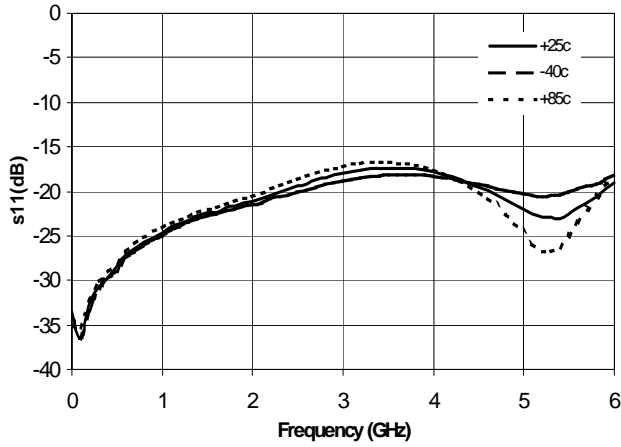

**$|S_{21}|$  vs. Frequency**

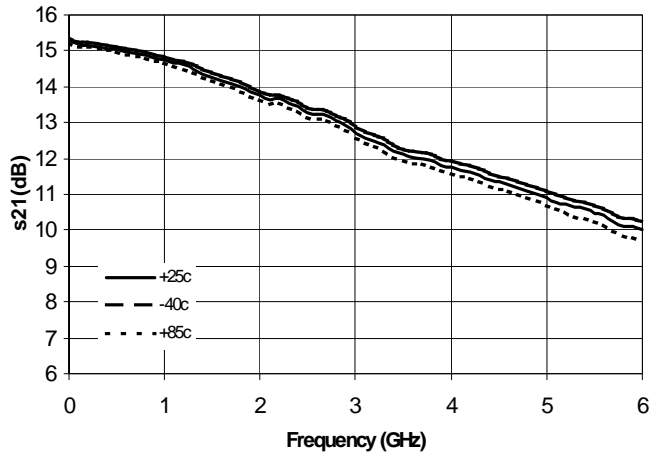

**$|S_{12}|$  vs. Frequency**

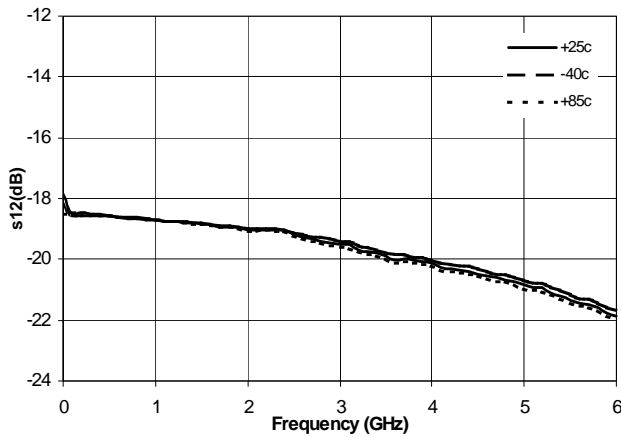

**$|S_{22}|$  vs. Frequency**

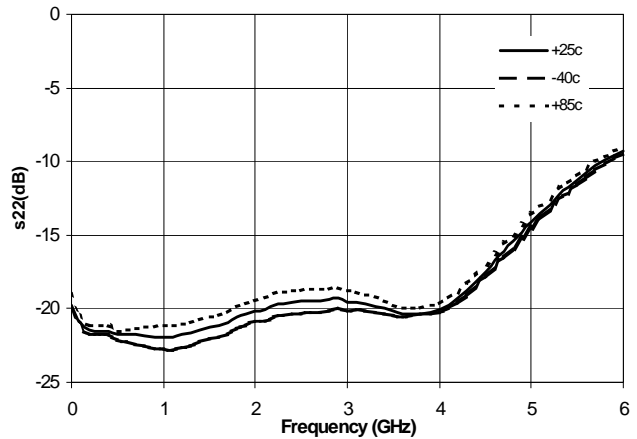

**SBA4086Z IS-95 @ 850MHz  
Adj. Channel Pwr. Vs. Channel Output Pwr.**

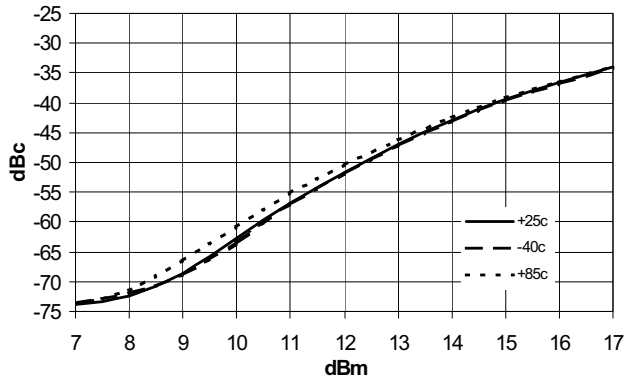

**SBA4086Z IS-95 @ 1950MHz  
Adj. Channel Pwr. Vs. Channel Output Pwr.**

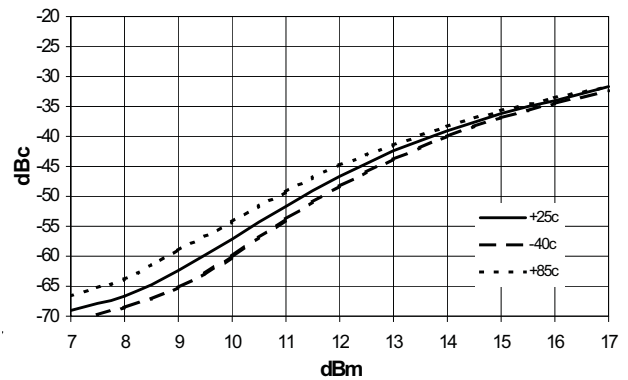

## Basic Application Circuit

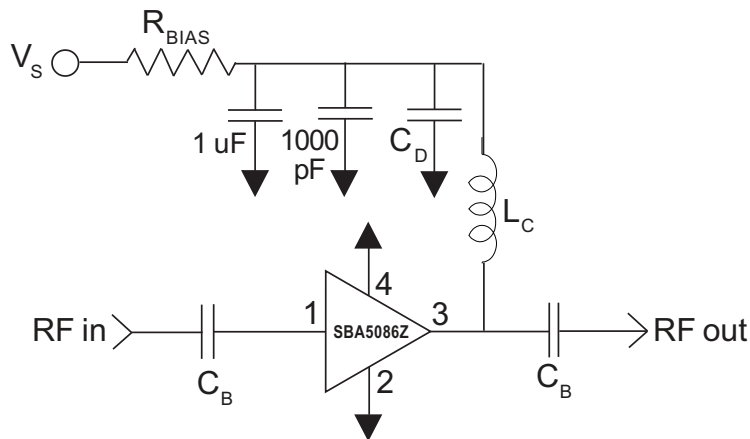

## Evaluation Board Layout

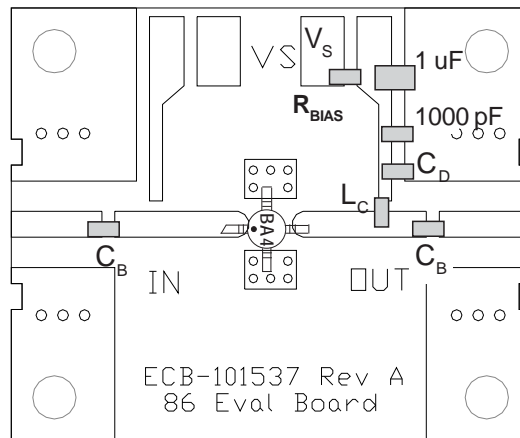

### Mounting Instructions:

1. Use a large ground pad area under device pins 2 and 4 with many plated through-holes as shown.
2. We recommend 1 or 2 ounce copper. Measurements for this data sheet were made on a 31mil thick FR-4 board with 1 ounce copper on both sides.

### Application Circuit Element Values

Reference Designator	500 MHz	850 MHz	1950 MHz	2400 MHz	3500 MHz
$C_B$	220 pF	100 pF	68 pF	56 pF	39 pF
$C_D$	100 pF	68 pF	22 pF	22 pF	15 pF
$L_C$	68 nH	33 nH	22 nH	18 nH	15 nH

### Recommended Bias Resistor Values for $I_D = 80 \text{ mA}$ , $R_{BIAS} = (V_S - V_D) / I_D$

Supply Voltage ( $V_S$ )	7.5V	8V	10V	12V
$R_{BIAS}$	33 $\Omega$	39 $\Omega$	68 $\Omega$	91 $\Omega$

Note:  $R_{BIAS}$  provides DC bias stability over temperature.

Pin	Function	Description
1	RF IN	RF input pin. This pin requires the use of an external DC-blocking capacitor chosen for the frequency of operation.
2, 4	GND	Connection to ground. Use via holes for best performance to reduce lead inductance as close to ground leads as possible.
3	RF OUT/BIAS	RF output and bias pin. DC voltage is present on this pin, therefore a DC-blocking capacitor is necessary for proper operation.

**PCB Pad Layout**

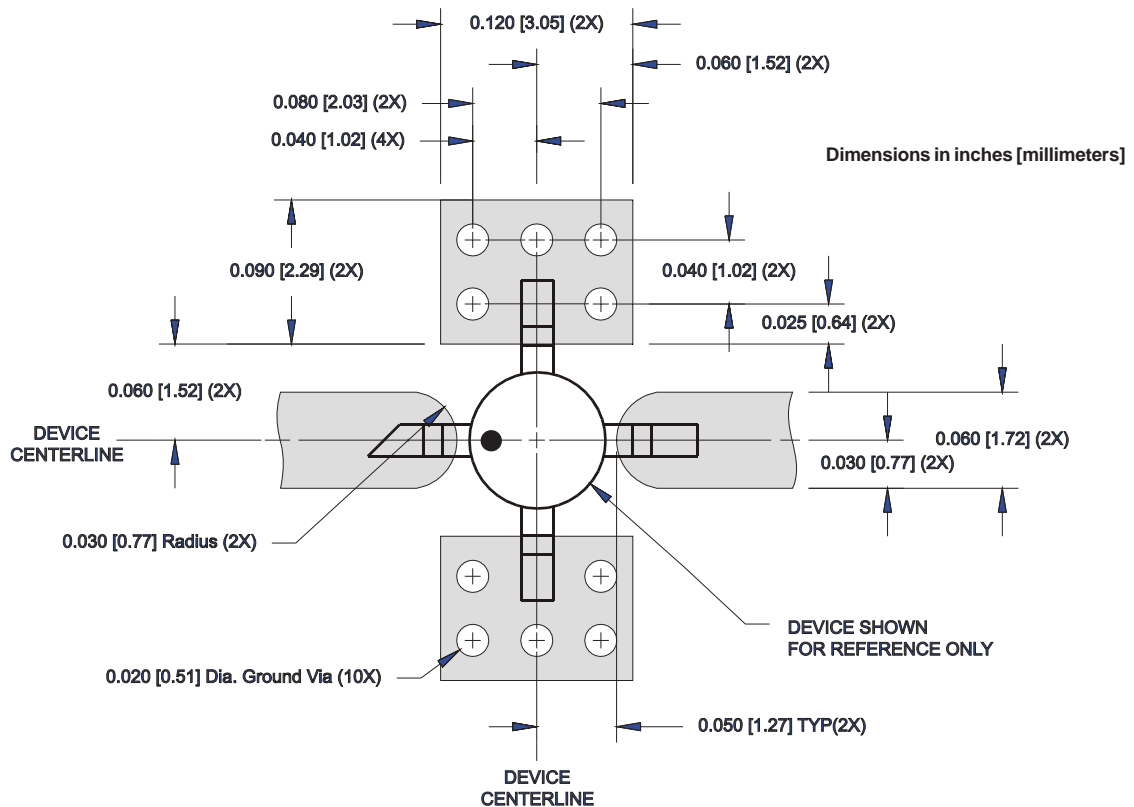

## Package Drawing

Dimensions in inches (millimeters)

Refer to drawing posted at [www.rfmd.com](http://www.rfmd.com) for tolerances.

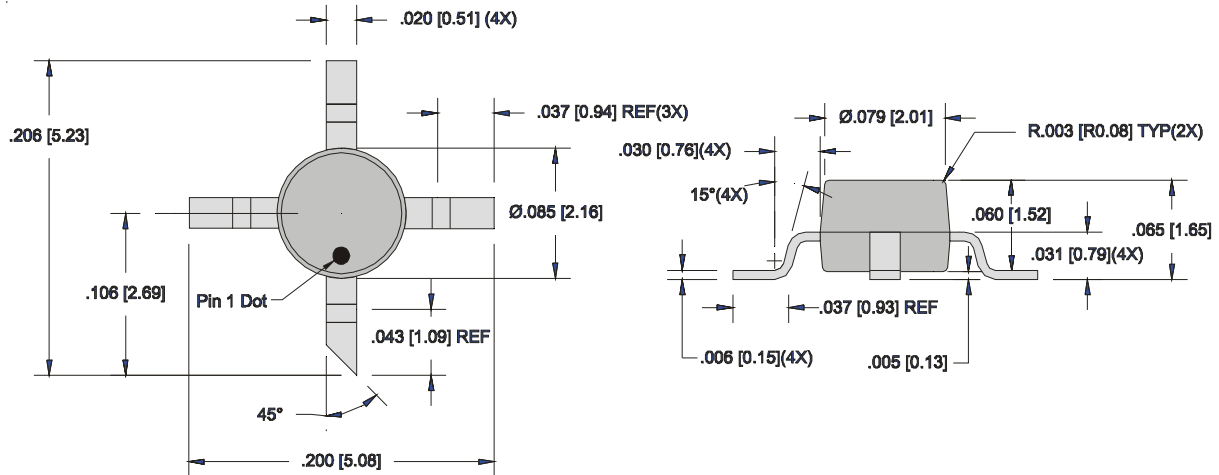

## Part Identification

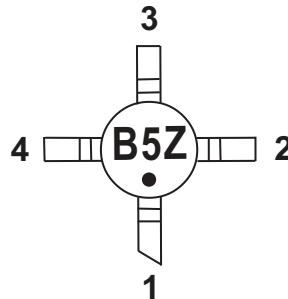

The part will be marked with "B4Z" designator on the top surface of the package.

## Ordering Information

Ordering Code	Description
SBA4086Z	7" Reel with 1000 pieces
SBA4086ZSQ	Sample bag with 25 pieces
SBA4086ZSR	7" Sample reel with 100 pieces
SBA4086ZPCK1	850MHz, 8V Operation PCBA with 5-piece sample bag