

RF3833

25W GaN Wide-Band Power Amplifier 30MHz to 2000MHz

The RF3833 is a wideband Power Amplifier designed for CW and pulsed applications such as wireless infrastructure, RADAR, two way radios, and general purpose amplification. Using an advanced high power density Gallium Nitride (GaN) semiconductor process, these high-performance amplifiers achieve high efficiency, flat gain, and large instantaneous bandwidth in a single amplifier design. The RF3833 is an input matched GaN transistor packaged in an air cavity copper package which provides excellent thermal stability through the use of advanced heat-sink and power dissipation technologies. Ease of integration is accomplished through the incorporation of optimized input matching network within the package that provides wideband gain and power performance in a single amplifier. An external output match offers the flexibility of further optimizing power and efficiency for any sub-band within the overall bandwidth.

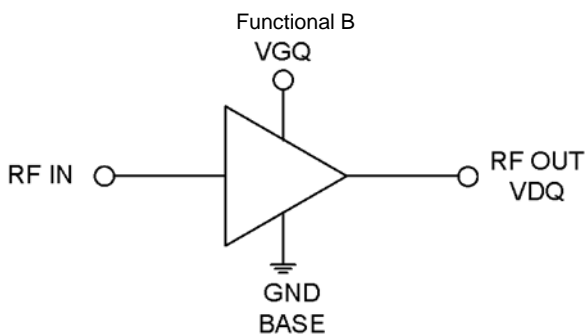

Functional Block Diagram

Ordering Information

RF3833S2	Sample bag with 2 pieces
RF3833SB	Bag with 5 pieces
RF3833SQ	Bag with 25 pieces
RF3833SR	Short Reel with 100 pieces
RF3833TR7	7" Reel with 750 pieces
RF3833PCBA-410	Evaluation Board: 30MHz to 2000MHz; 48V operation



Package: Air-Cavity Cu

Features

- Advanced GaN HEMT Technology
- Output Power of 25W
- Advanced Heat-Sink Technology
- 30MHz to 2000MHz Instantaneous Bandwidth
- Input Internally Matched to 50Ω
- 48V Operation Typical Performance
 - P_{OUT} 44.5dBm
 - Gain 11.5dB
 - Power Added Efficiency 50% (30MHz to 2000MHz)
- -40°C to 85°C Operating Temperature
- Large Signal Models Available
- EAR99 Export Control

Applications

- Class AB Operation for Public Mobile Radio
- Power Amplifier Stage for Commercial Wireless Infrastructure
- General Purpose Tx Amplification
- Test and Instrumentation
- Civilian and Military Radar

Absolute Maximum Ratings

Parameter	Rating	Unit
Drain Voltage (V_D)	150	V
Gate Voltage (V_G)	-8 to +2	V
Operational Voltage	50	V
RF - Input Power	36	dBm
Ruggedness (VSWR)	10:1	
Storage Temperature Range	-55 to +125	°C
Operating Temperature Range (T_o)	-40 to +85	°C
Operating Junction Temperature (T_J)	200	°C
Human Body Model	Class 1A	
MTTF ($T_J < 200$ °C, 95% Confidence Limits)*	3E + 06	Hours
Thermal Resistance, R_{TH} (junction to case) measured at $T_C = 85$ °C, DC bias only	5.2	°C/W



Caution! ESD sensitive device.



RoHS (Restriction of Hazardous Substances): Compliant per EU Directive 2011/65/EU.

Exceeding any one or a combination of the Absolute Maximum Rating conditions may cause permanent damage to the device. Extended application of Absolute Maximum Rating conditions to the device may reduce device reliability. Specified typical performance or functional operation of the device under Absolute Maximum Rating conditions is not implied.

* MTTF – median time to failure for wear-out failure mode (30% I_{DSS} degradation) which is determined by the technology process reliability. Refer to product qualification report for FIT (random) failure rate.

Operation of this device beyond any one of these limits may cause permanent damage. For reliable continuous operation, the device voltage and current must not exceed the maximum operating values specified in the table on page two.

Bias Conditions should also satisfy the following expression: $P_{DISS} < (T_J - T_C) / R_{TH J - C}$ and $T_C = T_{CASE}$

Nominal Operating Parameters

Parameter	Specification			Unit	Condition
	Min	Typ	Max		
Recommended Operating Conditions					
Drain Voltage (V_{DSQ})		48		V	Can also be operated at 28V with reduced P_{OUT}
Gate Voltage (V_{GSQ})			-2.5	V	
Drain Bias Current		88		mA	
RF Input Power (P_{IN})			35	dBm	
Input Source VSWR			10:1		
Maximum Gate Current (I_G)			15.25	mA	P3dB, CW
RF Performance Characteristics					
Frequency Range	30		2000	MHz	Small signal 3dB bandwidth
Linear Gain		14.8		dB	$P_{IN} = 0$ dBm, 30MHz to 2000MHz
Power Gain		11.6		dB	$P_{IN} = 33$ dBm, 30MHz to 2000MHz
Gain Variation with Temperature		-0.02		dB/°C	
Input Return Loss (S11)		-10		dB	
Output Power (P3dB)		44		dBm	30MHz to 2000MHz
Power Added Efficiency (PAE)		45		%	30MHz to 2000MHz

Parameter	Specification			Unit	Condition
	Min	Typ	Max		
RF Functional Tests					Test Conditions: VDSQ = 48V, IDQ = 88mA, CW, f = 2000MHz, T = 25°C, Performance in a standard tuned test fixture
V _{GSQ}		-3.1		V	
Power Gain		10.3		dB	P _{IN} = 33dBm
Input Return Loss		-9		dB	P _{IN} = 33dBm
Output Power		43.3		dBm	P _{IN} = 33dBm
Power Added Efficiency (PAE)		48		%	P _{IN} = 33dBm

Typical Performance in standard fixed tuned test fixture matched for 30MHz to 2000MHz
(T = 25°C, unless noted)

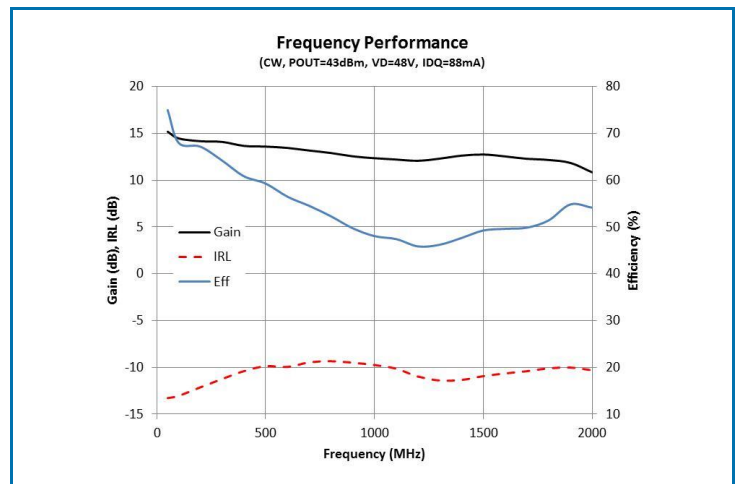
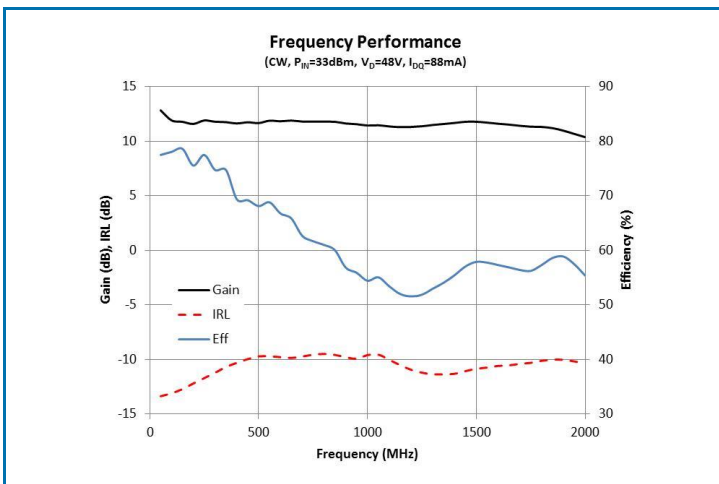
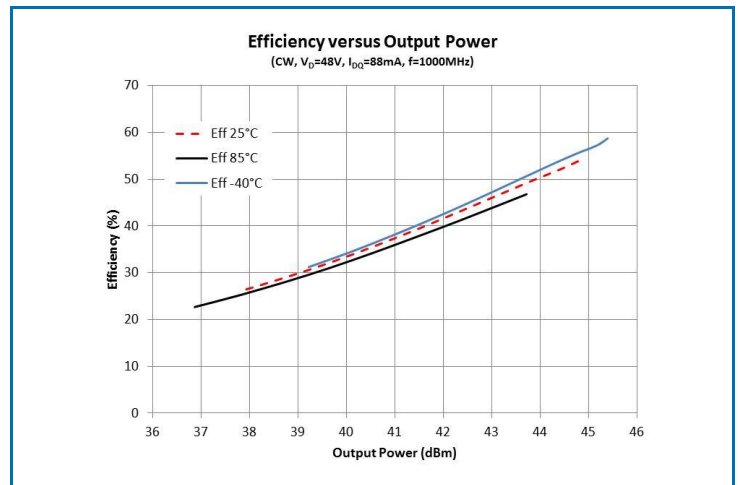
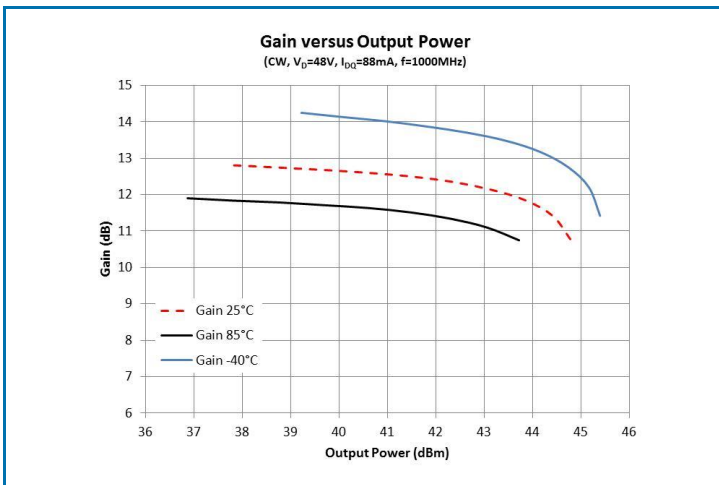
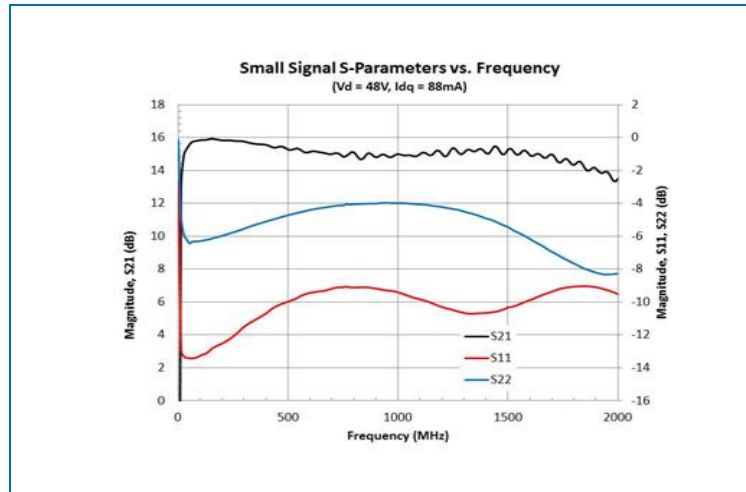

Typical Performance in standard fixed tuned test fixture matched for 30MHz to 2000MHz
(T = 25°C, unless noted) (continued)

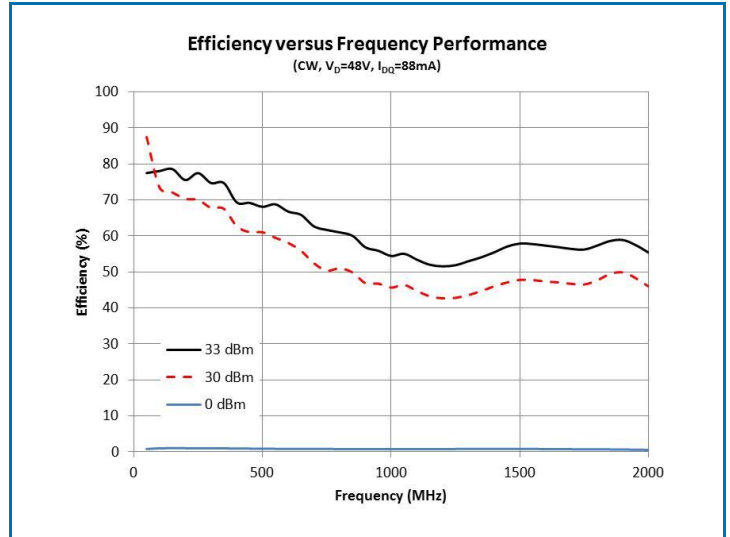
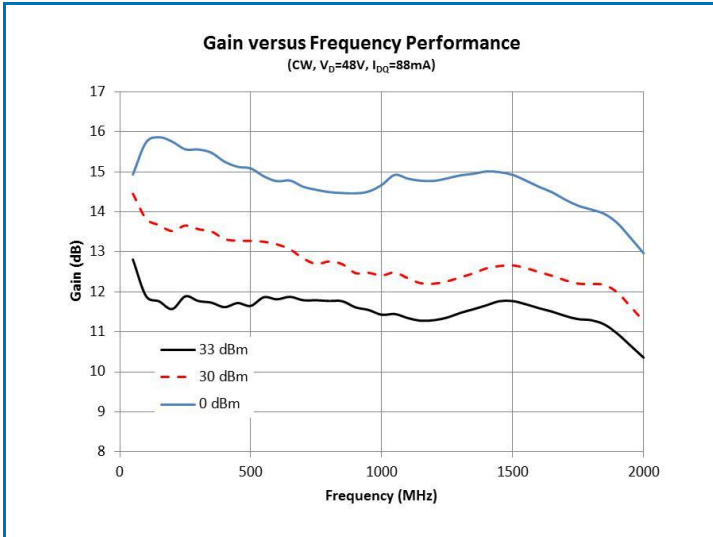
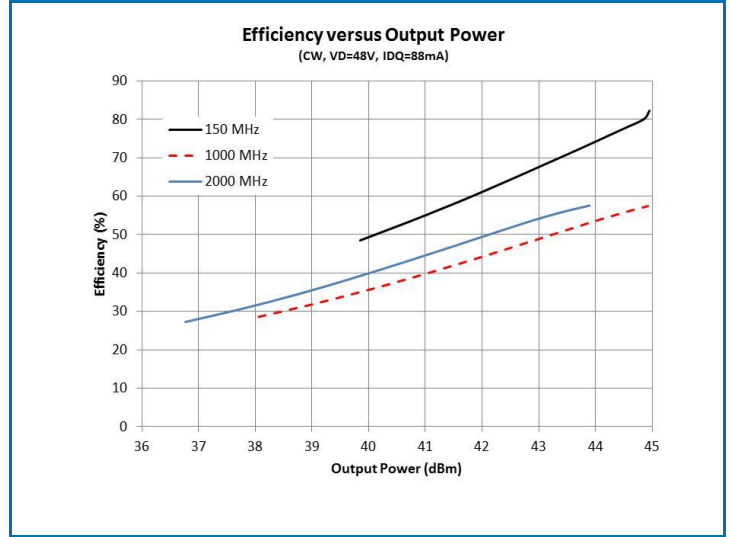
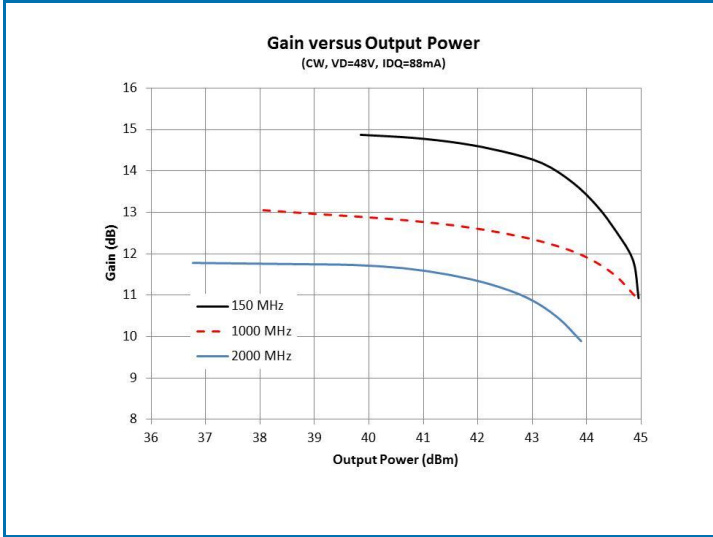

Evaluation Board Schematic

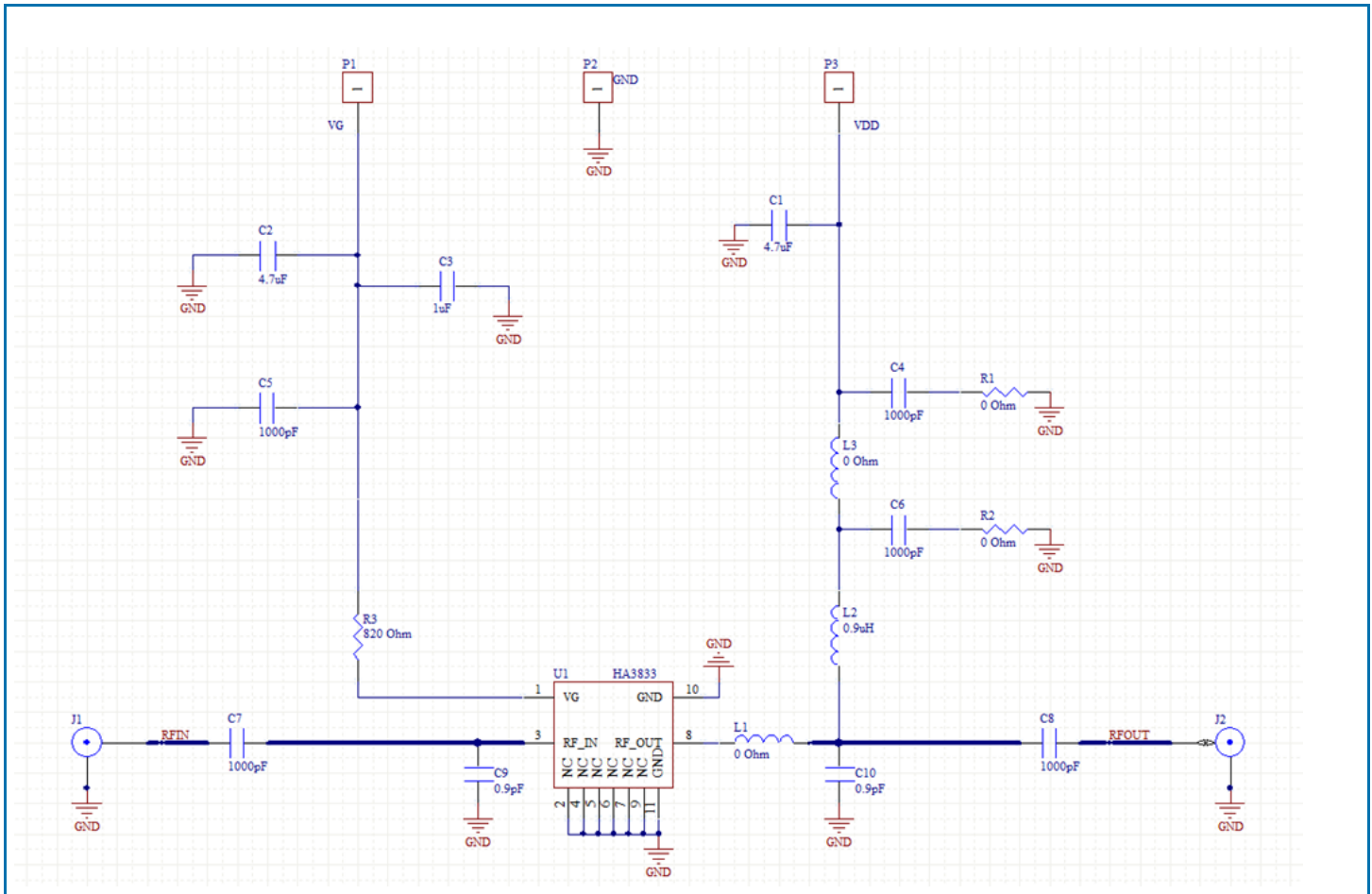

Evaluation Board Bill of Materials (BOM)*

Item	Value	Manufacturer	Manufacturer's P/N
C1, C2	4.7 μ F	Murata	GRM55ER72A47KA01L
C3	1.0 μ F	AVX Corp	12101C104KAZ2A
C4, C5, C6	1000pF	TDK Corp	C2012X7R2A102K085A
C7, C8	1000pF	DLI	C08BL102X-12N-X0T
C9, C10	0.9pF	ATC	800A0R9BT250X
R3	820 Ω	Panasonic	ERJ-3GEYJ821
L1, R1, R2	0 Ω	Panasonic	ERJ-3GSY0R00V
L2	0.9 μ H	Coilcraft	1008AF-901XJLB
L3	0 Ω	Kamaya	RMC1/10JPTP

*30MHz to 2000MHz RF3833PCBA-410

Package Drawing (Dimensions in millimeters)

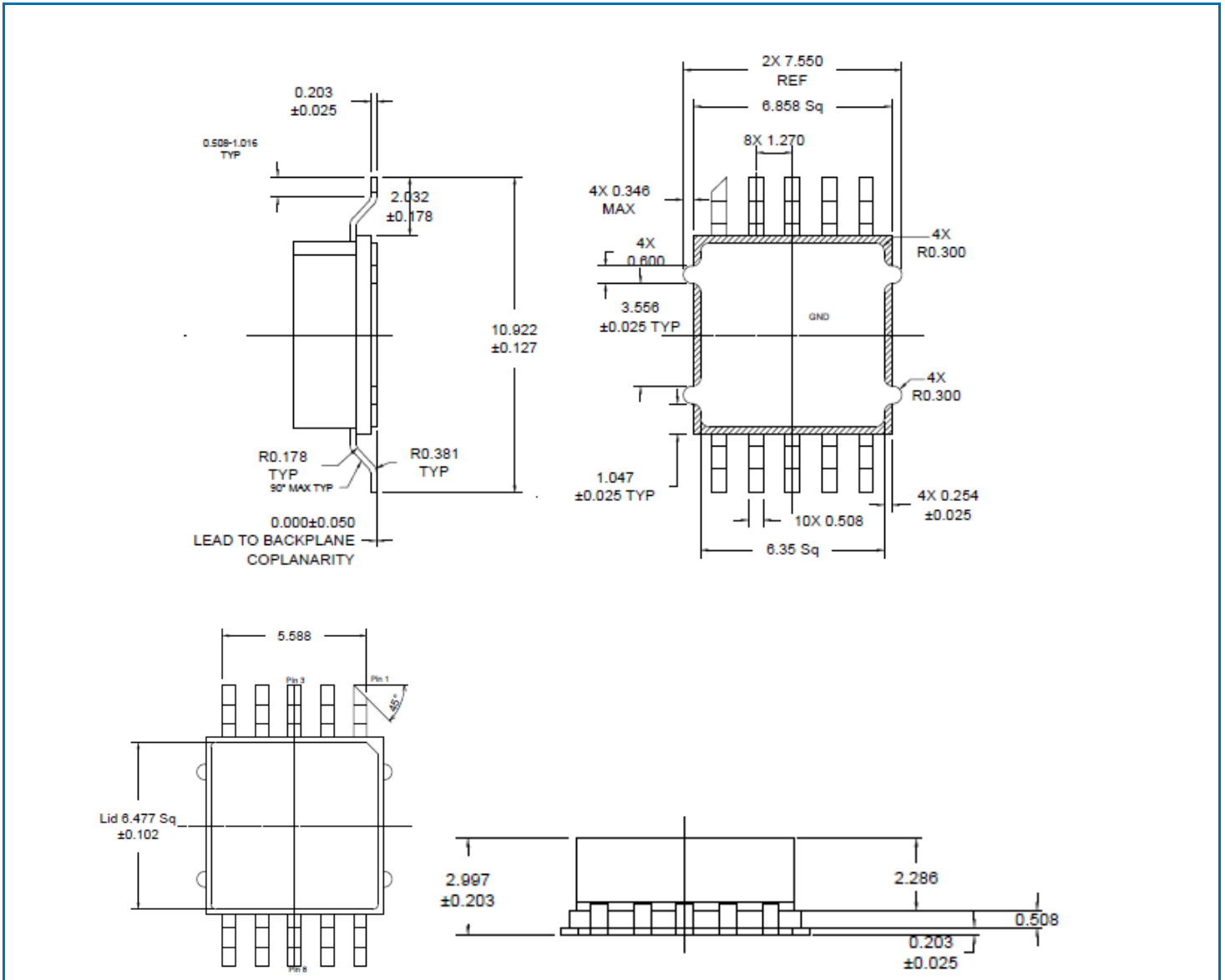

Pin Names and Descriptions

Pin	Name	Description
1	VGS	Gate DC Bias pin
2	N/C	No Internal Connection
3	RFIN	RF Input
4-7	N/C	No Internal Connection
8	RFOUT/VDS	RF Output/Drain DC Bias pin
9-10	N/C	No Internal Connection
Backside	GND	Ground

Bias Instruction for RF3833 Evaluation Board

- ESD Sensitive Material. Please use proper ESD precautions when handling devices of evaluation board.
 - Evaluation board requires additional external fan cooling.
 - Connect all supplies before powering evaluation board.
1. Connection RF cables at RFIN and RFOUT.
 2. Connect ground to the ground supply terminal, and ensure that both the VG and VD grounds are also connected to this ground terminal.
 3. Apply -5V to VG2.
 4. Apply 48V to VD2.
 5. Increase V_{G2} until drain current reaches 88mA or desired bias point.
 6. Turn on the RF input.
- Typical test data provided is measured to SMA connector reference plane, and include evaluation board/broadband bias network mismatch and losses

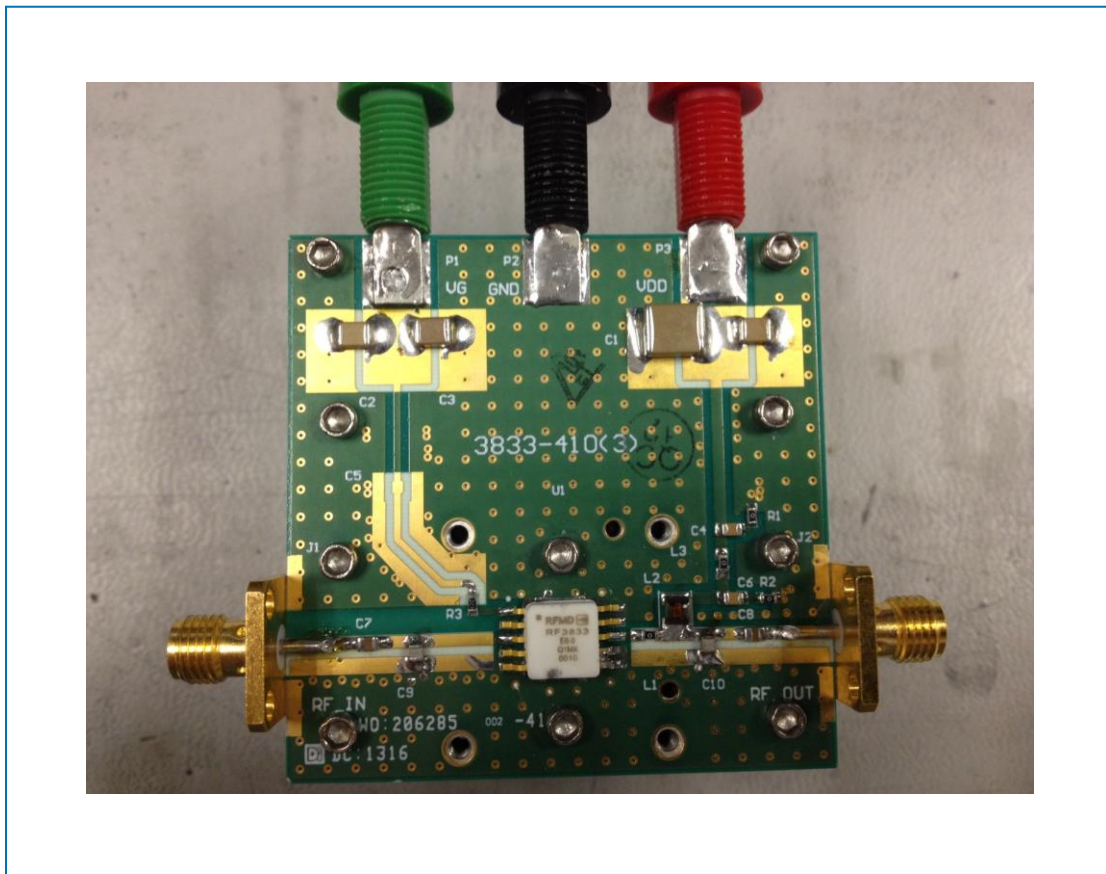

Evaluation Board Layout

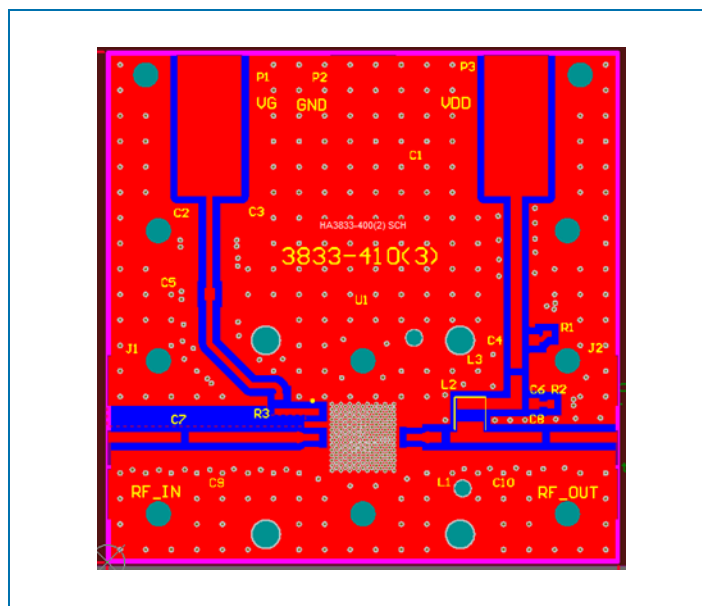

Device Impedances*

Frequency	RF3833PCBA-410 (30MHz to 2000MHz)	
	Z Source (Ω)	Z Load (Ω)
30MHz	50.19 – j2.98	48.43 + j6.33
200MHz	48.56 – j4.78	48.72 – j2.79
500MHz	42.59 – j7.54	41.82 – j7.06
800MHz	36.23 – j5.85	34.86 – j4.75
1000MHz	32.65 – j2.96	31.06 – j1.06
1200MHz	30.40 + j1.15	29.00 + j3.71
1500MHz	28.85 + j8.24	27.88 + j11.95
1800MHz	29.72 + j16.00	29.60 + j21.15
2000MHz	31.70 + j21.40	32.41 + j27.86

* Device impedances reported are the measured evaluation board impedances chosen for a tradeoff of efficiency and peak power performance across the entire frequency bandwidth.

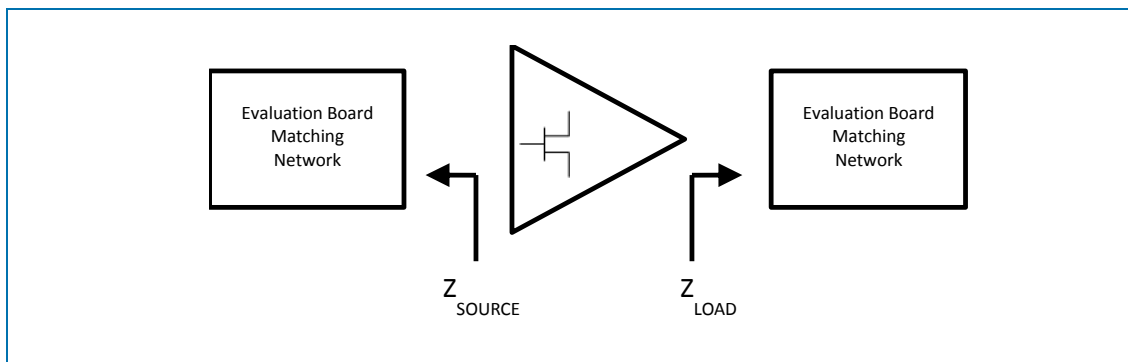

Device Handling/Environmental Conditions

RFMD does not recommend operating this device with typical drain voltage applied and the gate pinched off in a high humidity, high temperature environment.

GaN HEMT devices are ESD sensitive materials. Please use proper ESD precautions when handling devices or evaluation boards.

DC Bias

The GaN HEMT device is a depletion mode high electron mobility transistor (HEMT). At zero volts V_{GS} the drain of the device is saturated and uncontrolled drain current will destroy the transistor. The gate voltage must be taken to a potential lower than the source voltage to pinch off the device prior to applying the drain voltage, taking care not to exceed the gate voltage maximum limits. RFMD recommends applying $V_{GS} = -5V$ before applying any V_{DS} .

RF Power transistor performance capabilities are determined by the applied quiescent drain current. This drain current can be adjusted to trade off power, linearity, and efficiency characteristics of the device. The recommended quiescent drain current (I_{DQ}) shown in the RF typical performance table is chosen to best represent the operational characteristics for this device, considering manufacturing variations and expected performance. The user may choose alternate conditions for biasing this device based on performance tradeoffs.

Mounting and Thermal Considerations

The thermal resistance provided as R_{TH} (junction to case) represents only the packaged device thermal characteristics. This is measured using IR microscopy capturing the device under test temperature at the hottest spot of the die. At the same time, the package temperature is measured using a thermocouple touching the backside of the die embedded in the device heat-sink but sized to prevent the measurement system from impacting the results. Knowing the dissipated power at the time of the measurement, the thermal resistance is calculated.

In order to achieve the advertised MTTF, proper heat removal must be considered to maintain the junction at or below the maximum of 200°C. Proper thermal design includes consideration of ambient temperature and the thermal resistance from ambient to the back of the package including heat-sinking systems and air flow mechanisms. Incorporating the dissipated DC power, it is possible to calculate the junction temperature of the device.