

RoHS Compliant & Pb-Free Product  
Package Style: SOT 5-Lead

**Features**

- 150MHz to 2500MHz Operation
- 2.7V to 6.0V Single Supply
- +18dBm Output IP<sub>3</sub> at 5V
- 14dB Gain at 900MHz
- 8.6dB Gain at 1900MHz
- Low Current Consumption of 5mA at 3V

**Applications**

- Broadband Gain Blocks
- Final PA for Low-Power Applications
- IF or RF Buffer Amplifiers
- Driver Stage for Power Amplifiers
- Oscillator Loop Amplifiers

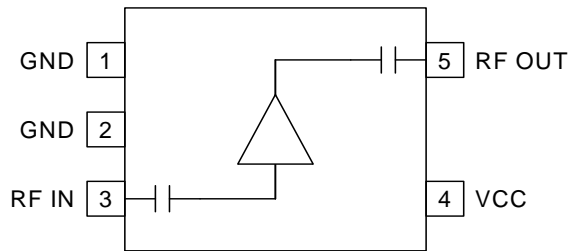

Functional Block Diagram

**Product Description**

The RF2314 is a general purpose, low-cost, high performance amplifier designed for operation from a 2.7V to 6V supply with low current consumption. The circuit configuration with resistive feedback allows for broadband cascadable amplification. Feedback with capacitive compensation extends the bandwidth of the amplifier, and is designed for optimized noise figure. The device is unconditionally stable and internally matched to 50Ω. **No external components** are required. The RF2314 is available in a very small industry-standard SOT 5-lead surface mount package, enabling compact designs which conserve board space.

**Ordering Information**

RF2314                      General Purpose Low Noise Amplifier  
RF2314PCBA-41X        Fully Assembled Evaluation Board

**Optimum Technology Matching® Applied**

- |  |                                      |                                     |                                   |
|--|--------------------------------------|-------------------------------------|-----------------------------------|
| <input checked="" type="checkbox"/> GaAs HBT | <input type="checkbox"/> SiGe BiCMOS | <input type="checkbox"/> GaAs pHEMT | <input type="checkbox"/> GaN HEMT |
| <input type="checkbox"/> GaAs MESFET         | <input type="checkbox"/> Si BiCMOS   | <input type="checkbox"/> Si CMOS    | <input type="checkbox"/> RF MEMS  |
| <input type="checkbox"/> InGaP HBT           | <input type="checkbox"/> SiGe HBT    | <input type="checkbox"/> Si BJT     |                                   |

RF MICRO DEVICES®, RFMD®, Optimum Technology Matching®, Enabling Wireless Connectivity™, PowerStar®, POLARIS™ TOTAL RADIO™ and UltimateBlue™ are trademarks of RFMD, LLC. BLUETOOTH is a trademark owned by Bluetooth SIG, Inc., U.S.A. and licensed for use by RFMD. All other trade names, trademarks and registered trademarks are the property of their respective owners. ©2006, RF Micro Devices, Inc.

## Absolute Maximum Ratings

Parameter	Rating	Unit
Supply Voltage	8.0	V
Supply Current	32	mA
Storage Temperature	-40 to +150	°C



**Caution!** ESD sensitive device.

Exceeding any one or a combination of the Absolute Maximum Rating conditions may cause permanent damage to the device. Extended application of Absolute Maximum Rating conditions to the device may reduce device reliability. Specified typical performance or functional operation of the device under Absolute Maximum Rating conditions is not implied.

RoHS status based on EU Directive 2002/95/EC (at time of this document revision).

The information in this publication is believed to be accurate and reliable. However, no responsibility is assumed by RF Micro Devices, Inc. ("RFMD") for its use, nor for any infringement of patents, or other rights of third parties, resulting from its use. No license is granted by implication or otherwise under any patent or patent rights of RFMD. RFMD reserves the right to change component circuitry, recommended application circuitry and specifications at any time without prior notice.

Parameter	Specification			Unit	Condition
	Min.	Typ.	Max.		
<b>Operating Range</b>					
Overall Frequency Range	150		2500	MHz	
Supply Voltage	2.7		6.0	V	
Operating Current (I <sub>CC</sub> )	2	5.7	9	mA	V <sub>CC</sub> =3V, Temp=27°C
	9	12.5	16	mA	V <sub>CC</sub> =5V, Temp=27°C
Operating Ambient Temperature	-40		+85	°C	
<b>3.0V Performance</b>					
Gain		16.6		dB	Freq=150MHz, V <sub>CC</sub> =3V, Temp=27°C
Gain	11	12.9	14	dB	Freq=900MHz, V <sub>CC</sub> =3V, Temp=27°C
Noise Figure		1.4		dB	
OIP3	+3	+9		dBm	
OP1dB	-4	-1	+1	dBm	
Input Return Loss		10		dB	
Output Return Loss		17		dB	
Isolation		20		dB	
Gain	6.5	7.9	9	dB	Freq=1900MHz, V <sub>CC</sub> =3V, Temp=27°C
OIP3	+9	+12.5		dBm	
OP1dB	-2	-0.5	+1	dBm	
Gain	4	5.2	7	dB	Freq=2400MHz, V <sub>CC</sub> =3V, Temp=27°C
OIP3	+11	+15.3		dBm	
OP1dB	-1	+1.1	+3	dBm	

NOT FOR NEW DESIGN

Parameter	Specification			Unit	Condition
	Min.	Typ.	Max.		
<b>5.0V Performance</b>					
Gain		19.1		dB	Freq = 150MHz, V <sub>CC</sub> = 5V, Temp = 27°C
Gain	12	14.2	16	dB	Freq = 900MHz, V <sub>CC</sub> = 5V, Temp = 27°C
Noise Figure		1.5		dB	
OIP3	+14	+18		dBm	
OP1dB	+3	+8	+11	dBm	
Input Return Loss		13		dB	
Output Return Loss		28		dB	
Isolation		20		dB	
Gain	6	8.2	10	dB	Freq = 1900MHz, V <sub>CC</sub> = 5V, Temp = 27°C
OIP3	+18	+22		dBm	
OP1dB	+5	+6.7	+9	dBm	
Gain	3.5	5.1	7	dB	Freq = 2400MHz, V <sub>CC</sub> = 5V, Temp = 27°C
OIP3	+19	+23		dB	
OP1dB	+6	+7.9	+10	dB	

NOT FOR NEW DESIGNS

Pin	Function	Description	Interface Schematic
1	GND	Ground connection. For best performance, keep traces physically short and connect immediately to ground plane.	
2	GND	Same as pin 1.	
3	RF IN	RF input pin. This pin is internally DC-blocked and thus does not require an external blocking capacitor. The input impedance of this pin is internally matched to 50Ω using resistive feedback.	
4	VCC	Supply connection. Generally, there is no need for an external bypass capacitor.	See pin 3 schematic.
5	RF OUT	RF output pin. The output impedance of this pin is internally matched to 50Ω using resistive feedback.	See pin 3 schematic.

## Package Drawing

Package Style: SOT 5-Lead

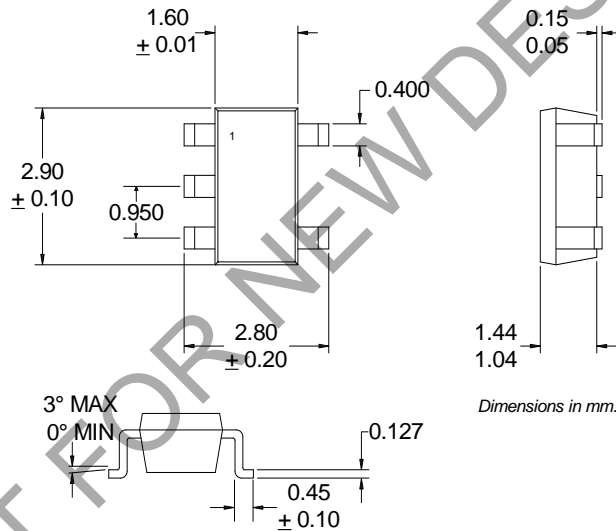

## Application Schematic

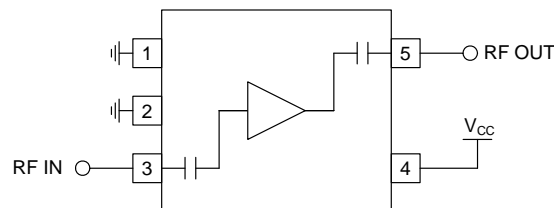

Evaluation Board Schematic

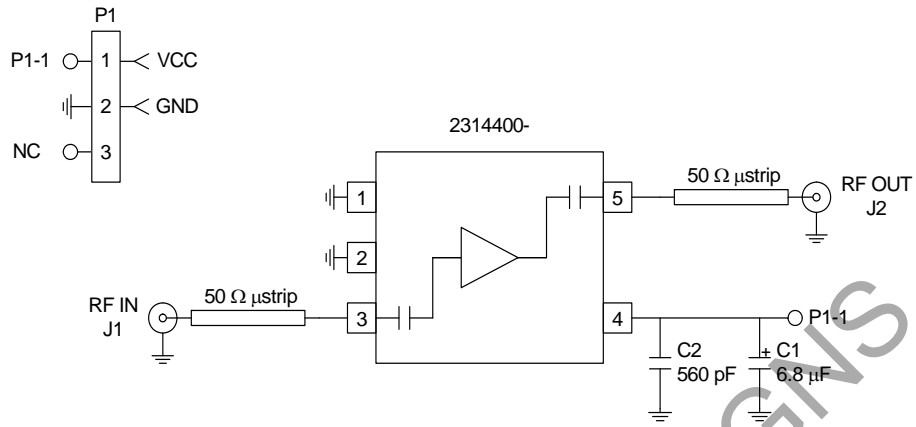

NOT FOR NEW DESIGNS

## Evaluation Board Layout Board Size 1.0" x 1.0" Board Thickness 0.031", Board Material FR-4

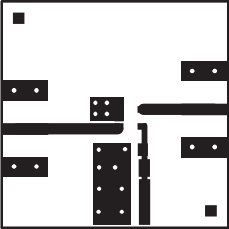
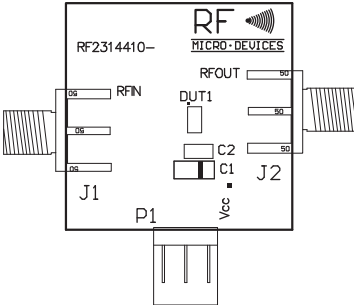

NOT FOR NEW DESIGNS

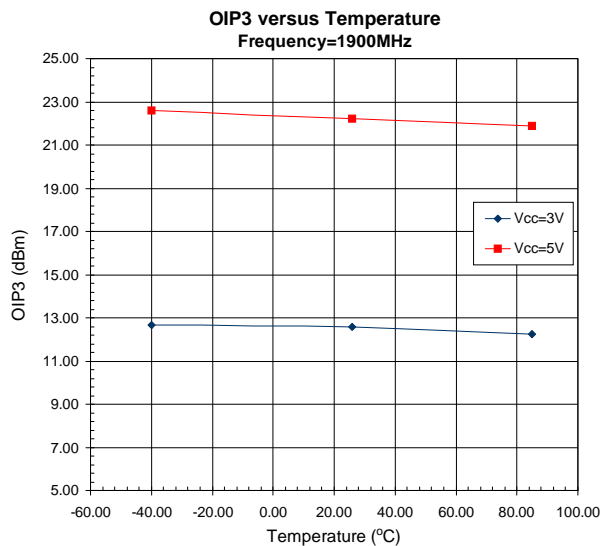
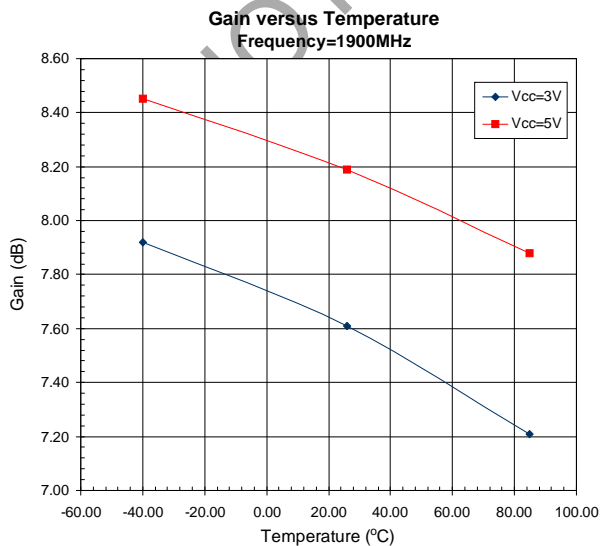
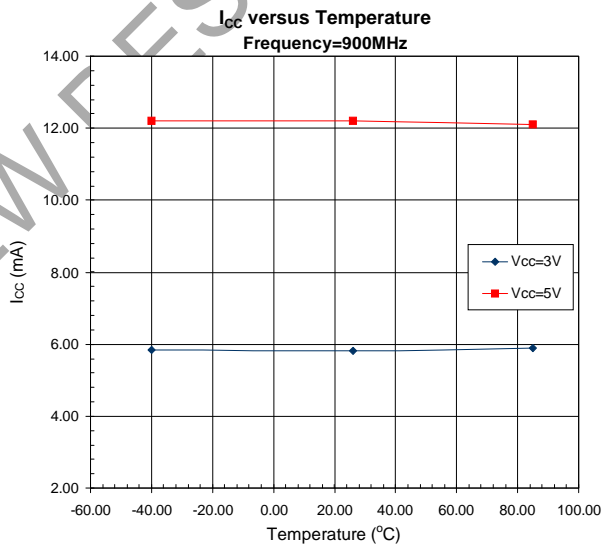
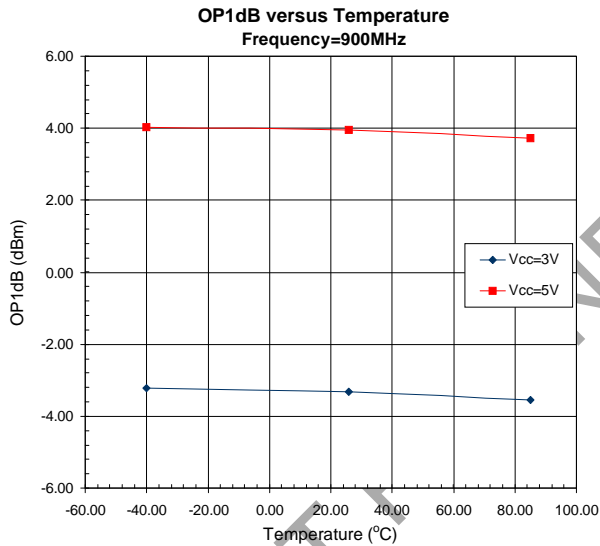
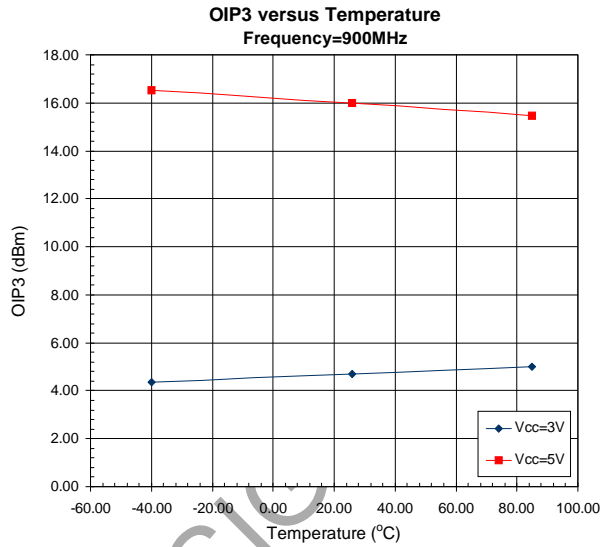
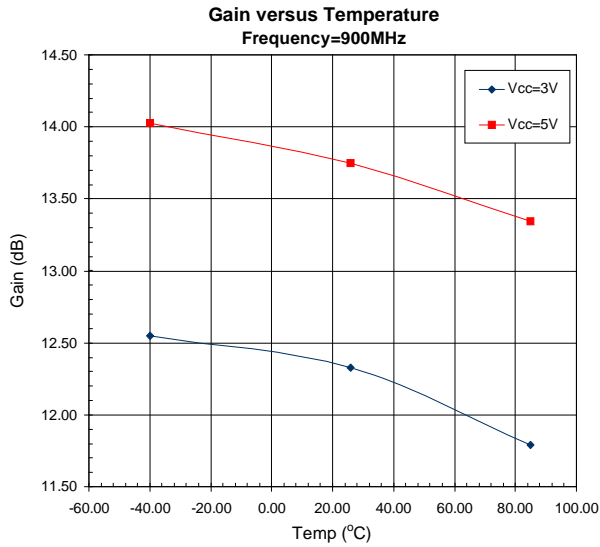

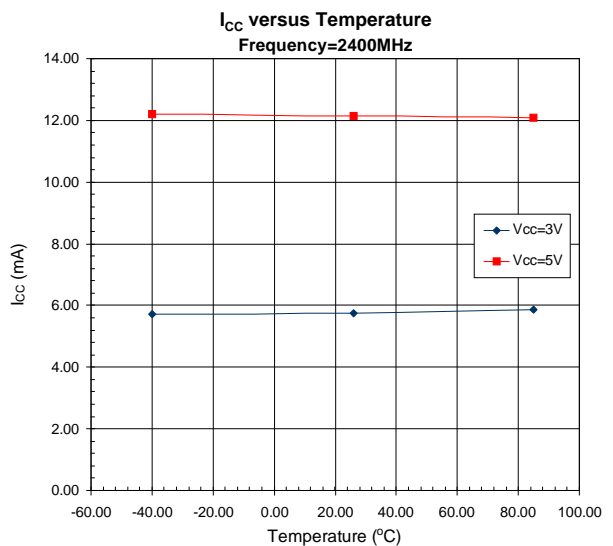
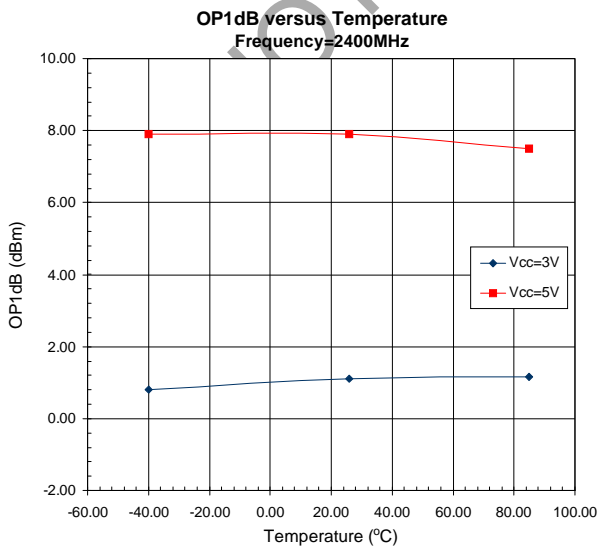
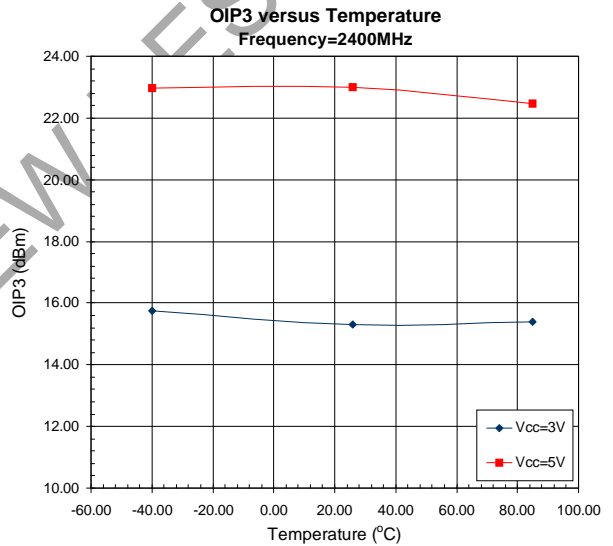
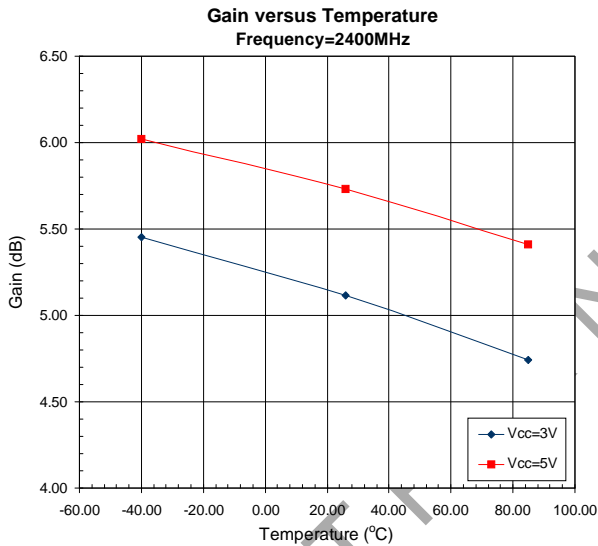
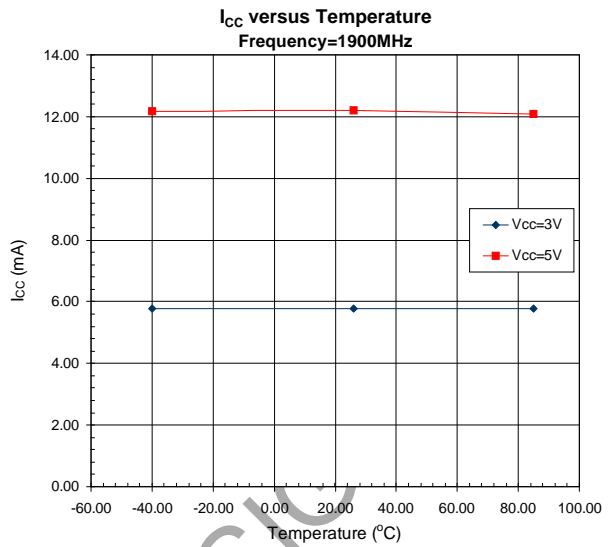
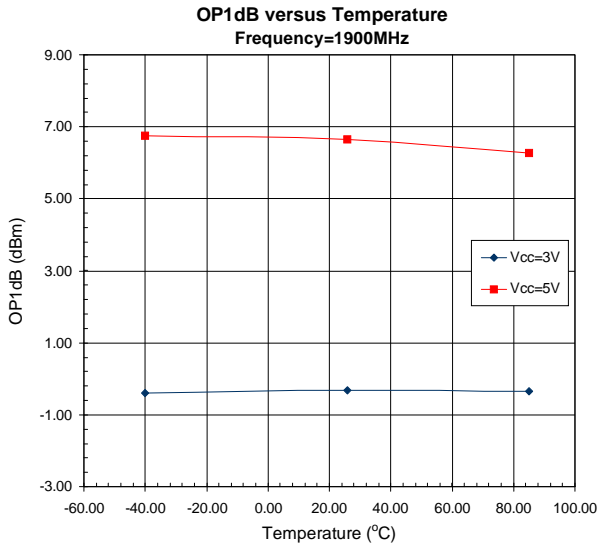



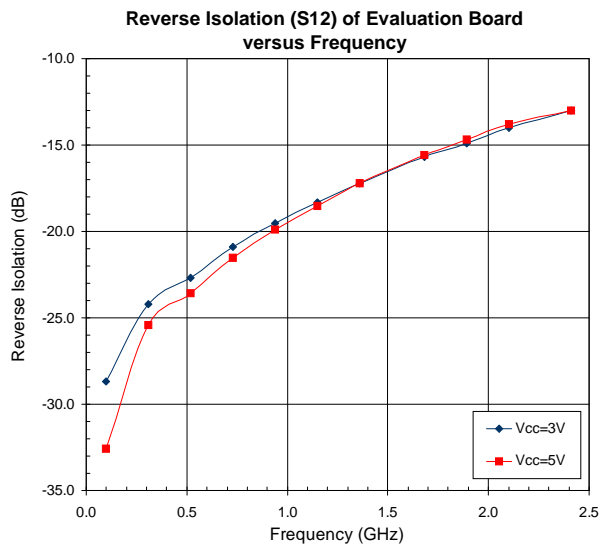
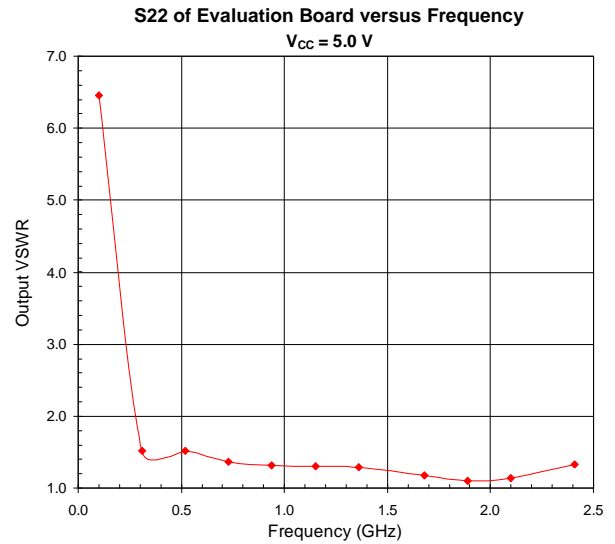
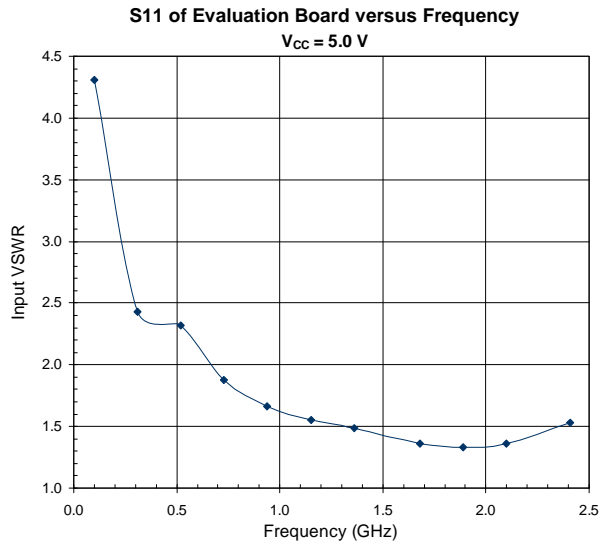
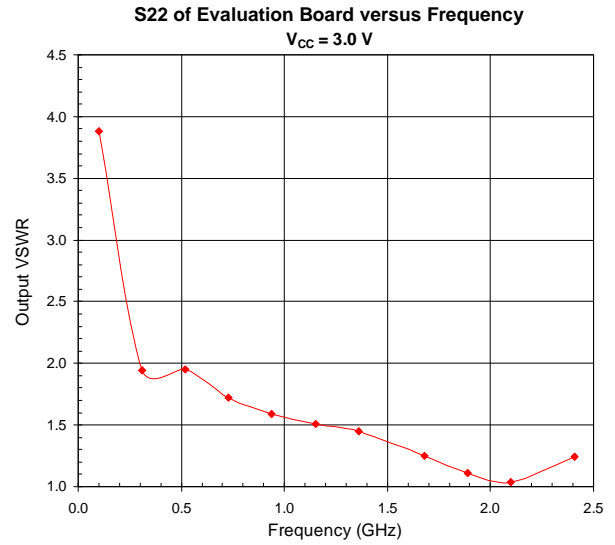
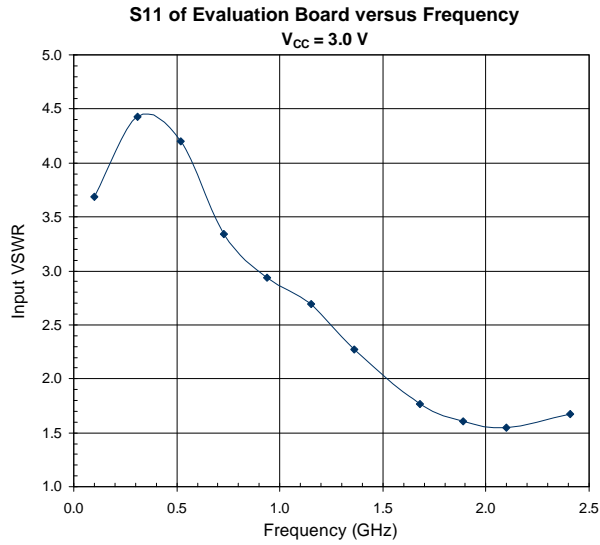

### S11 Plot, $V_{CC} = 3V$

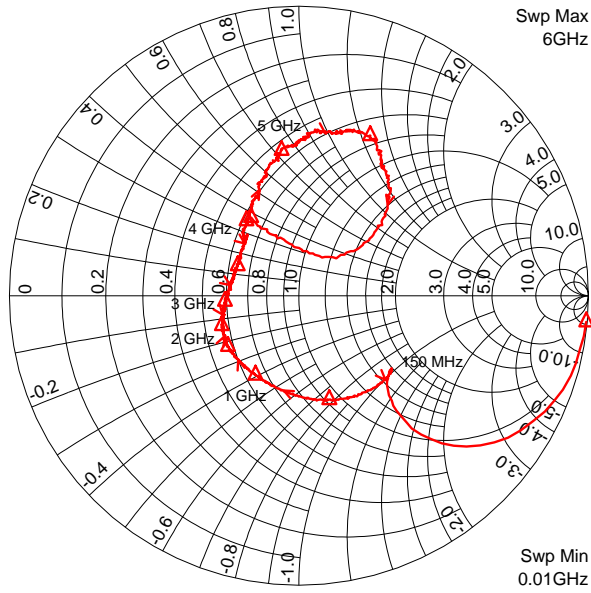

### S22 Plot, $V_{CC} = 3V$

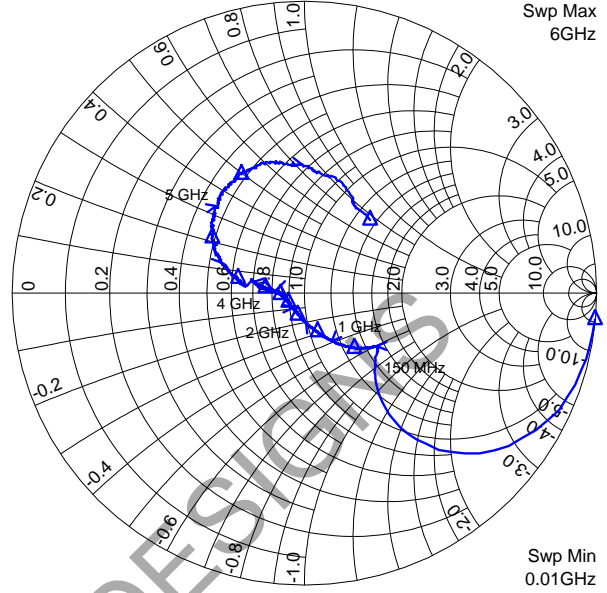

### S11 Plot, $V_{CC} = 5V$

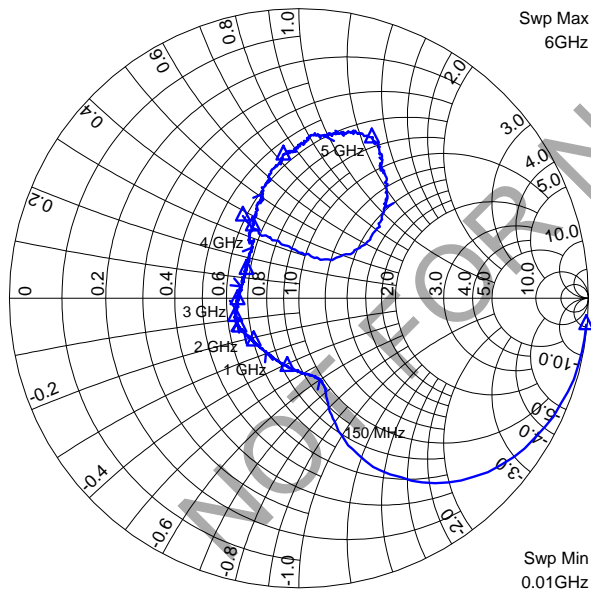

### S22 Plot, $V_{CC} = 5V$

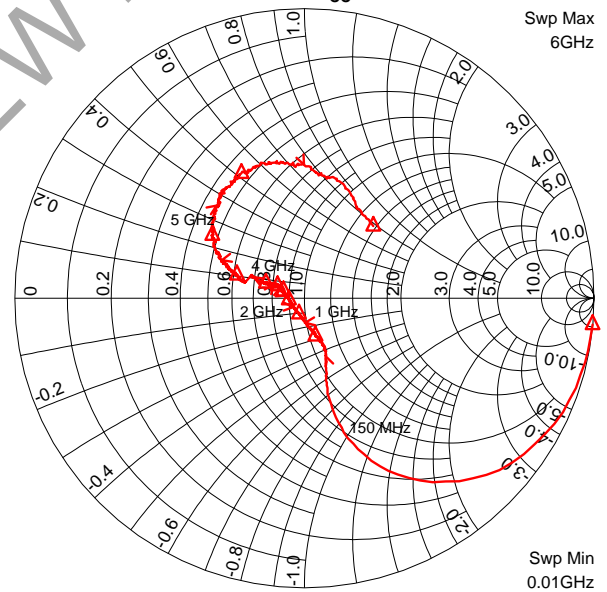

## PCB Design Requirements

### PCB Surface Finish

The PCB surface finish used for RFMD's qualification process is Electroless Nickel, immersion Gold. Typical thickness is 3µinch to 8µinch Gold over 180µinch Nickel.

### PCB Land Pattern Recommendation

PCB land patterns are based on IPC-SM-782 standards when possible. The pad pattern shown has been developed and tested for optimized assembly at RFMD; however, it may require some modifications to address company specific assembly processes. The PCB land pattern has been developed to accommodate lead and package tolerances.

### PCB Metal Land Pattern

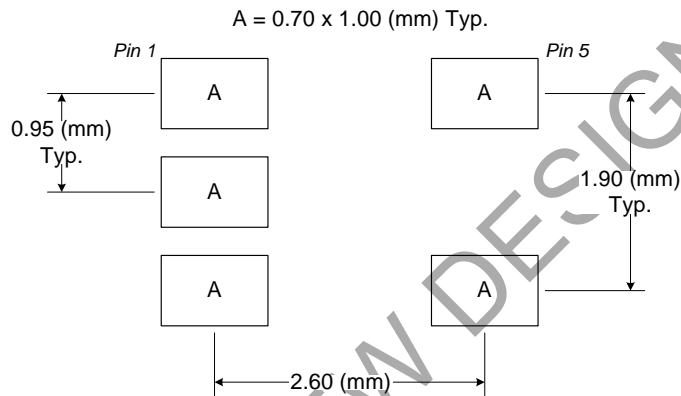

Figure 1. PCB Metal Land Pattern (Top View)

### PCB Solder Mask Pattern

Liquid Photo-Imageable (LPI) solder mask is recommended. The solder mask footprint will match what is shown for the PCB metal land pattern with a 3mil expansion to accommodate solder mask registration clearance around all pads. The center-grounding pad shall also have a solder mask clearance. Expansion of the pads to create solder mask clearance can be provided in the master data or requested from the PCB fabrication supplier.

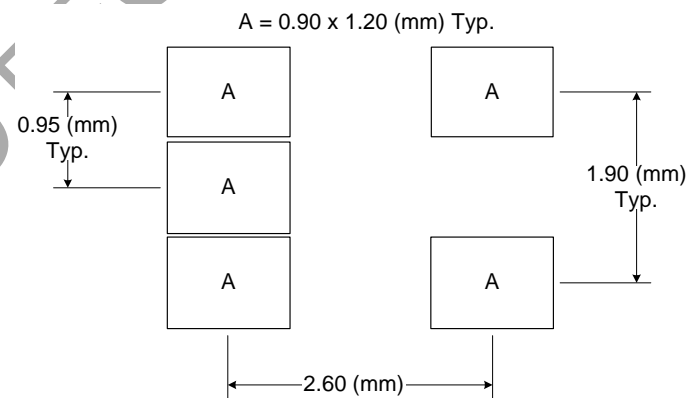

Figure 2. PCB Solder Mask Pattern (Top View)

## RoHS\* Banned Material Content

RoHS Compliant: Yes  
 Package total weight in grams (g): 0.014  
 Compliance Date Code: 0521  
 Bill of Materials Revision: -  
 Pb Free Category: e3

Bill of Materials	Parts Per Million (PPM)					
	Pb	Cd	Hg	Cr VI	PBB	PBDE
Die	0	0	0	0	0	0
Molding Compound	0	0	0	0	0	0
Lead Frame	0	0	0	0	0	0
Die Attach Epoxy	0	0	0	0	0	0
Wire	0	0	0	0	0	0
Solder Plating	0	0	0	0	0	0

This RoHS banned material content declaration was prepared solely on information, including analytical data, provided to RFMD by its suppliers, and applies to the Bill of Materials (BOM) revision noted

\* DIRECTIVE 2002/95/EC OF THE EUROPEAN PARLIAMENT AND OF THE COUNCIL of 27 January 2003 on the restriction of the use of certain hazardous substances in electrical and electronic equipment

**Please contact  
 RFMD Technical Support  
 at (336) 678-5570  
 for more information.**

NOT FOR NEW DESIGNS