

ZL9006MEVAL1Z, ZL9010MEVAL1Z
6A and 10A Evaluation Board Setup Procedure

AN1828
Rev 0.00
March 19, 2013

The ZL9006M, ZL9010M is a variable output, step-down PMBus-compliant digital power supply. Included in the module is a high-performance digital PWM controller, power MOSFETs, an inductor, and all the passive components required for a highly integrated DC/DC power solution. This power module has built-in auto-compensation algorithms, which eliminate the need for manual compensation design work. The ZL9006M, ZL9010M operates over a wide input voltage range and supports an output voltage range of 0.6V to 3.6V, which can be set by external resistors or via PMBus. Only bulk input and output capacitors are needed to finish the design. The output voltage can be precisely regulated to as low as 0.6V with $\pm 1\%$ output voltage regulation over line, load, and temperature variations.

The ZL9006M, ZL9010M functions as a switch mode power supply with added benefits of auto compensation, programmable power management features, parametric monitoring, and status reporting capabilities.

The ZL9006M, ZL9010M is packaged in a thermally enhanced, compact (17.2mmx11.45mm) and low profile (2.5mm) over-molded high-density array (HDA) package module suitable for automated assembly by standard surface mount equipment. The ZL9006M, ZL9010M is Pb-free and RoHS compliant.

Figure 1 represents a typical implementation of the ZL9006M, ZL9010M. For PMBus operation, it is recommended to tie the Enable pin (EN) to "disable" mode.

Recommended Equipment

- 0V to 15V power supply with at least 5A source current capability
- Electronic load capable of sinking current up to 10A
- Digital multimeters (DMMs)
- 100MHz quad-trace oscilloscope

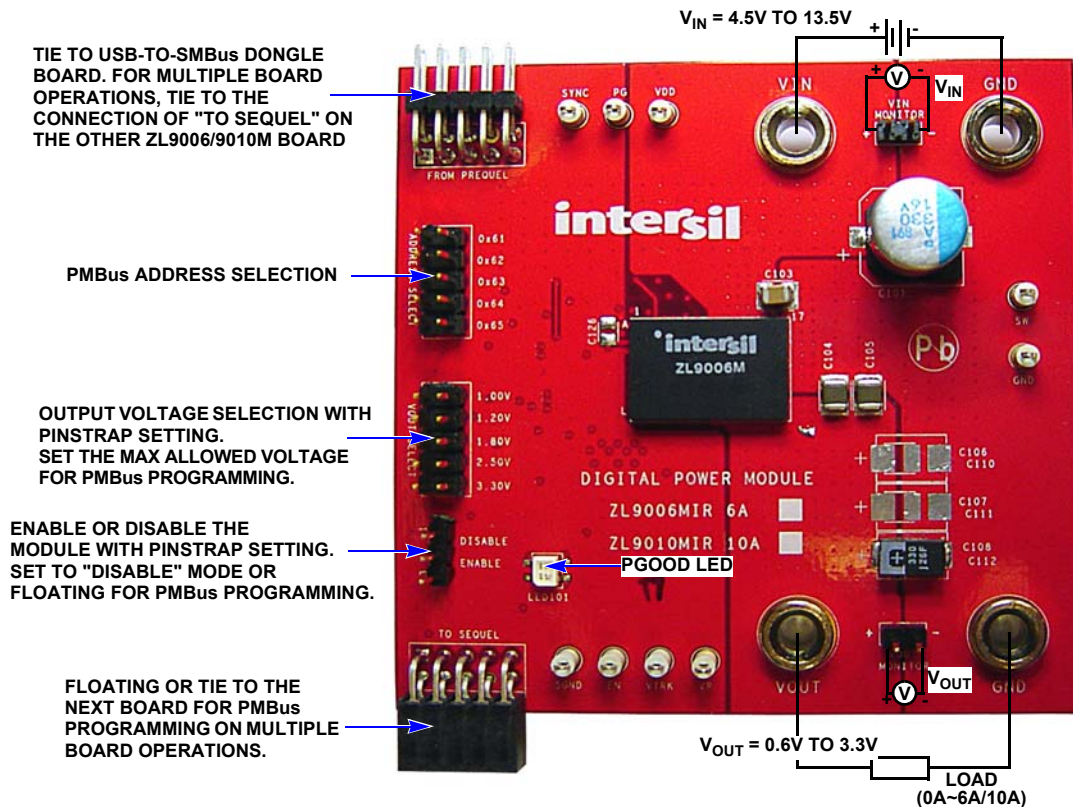

FIGURE 1. ZL9006M, ZL9010M BOARD IMAGE

Quick Start

The inputs are P2A (VIN) and P2B (GND). The outputs are P1A (VOUT) and P1B (GND). Refer to Figure 1 for connections. There are two ways to evaluate this evaluation board: I²C/PMBus programming (Steps 1 through 4) and quick pinstrap power-up (Step 6).

1. Install the PowerNavigator™ software using the CD included in the ZL9006M, ZL9010M kit. For PMBus operation, connect the USB-to-PMBus dongle board to J7 of the ZL9006M, ZL9010M board and connect the USB cable from the computer to the dongle board.
2. Connect a power supply capable of sourcing at least 5A to the input (VIN P2A & GND P2B) of the ZL9006M, ZL9010M evaluation board, with a voltage between 4.5V to 13.5V. Connect an electronic load or the device to be powered to the output (VOUT P1A & GND P1B) of the board. All connections, the low voltage and high current V_{OUT} lines should be able to carry the desired load current and should be made as short as possible.
3. Check the connections of "VOUT select" and "address select". Make sure that the selections are correct. When changing the output voltage through the I²C/PMBus, the voltage pinstrap sets the maximum allowed voltage. Thus, check the pinstrap setting on J5 before programming to a higher output voltage. For single board operations, the "address select" connection can be floating or any address listed on the board. But for multiple board operations, each board should have a unique address.
4. Move the ENABLE switch to "DISABLE" and turn on the power to program the power module using powerNavigator evaluation software. It allows modification of all ZL9006/9010M PMBus parameters. See Application Note [AN2033](#) for PMBus command details. Use the mouse-over pop-ups for PowerNavigator help.
5. After programming, the ENABLE switch can then be moved to "ENABLE" and the ZL9006M, ZL9010M can be tested. Alternately, the PMBus ONOFF, CONFIG, and OPERATION commands can be used.
6. Pinstrap power-up option: if no I²C/PMBus device is available to program the power module, the pinstrap option can allow users to power up the device to check the electrical functions without I²C/PMBus connections. Simply follow Step 2 to connect the wires, then turn on the ENABLE switch. There are two pinstrap functions to be configured: Voltage and PMBus address. Ensure that input power is turned off, and then set the address and voltage pinstraps using J4 and J5. If no voltage is selected on J5, the default output voltage is 1.5V.

For different input and output voltages, the switching frequency will need to be adjusted, as shown in Table 1. The default frequency is 615kHz.

TABLE 1. RECOMMENDED FREQUENCY FOR DIFFERENT INPUT AND OUTPUT VOLTAGES

V _{OUT} -V _{IN}	3.3V	5.0V	12.0V
0.6 - 1.5	300kHz	400kHz	400kHz
1.5 - 2.5	300kHz	615kHz	615kHz
2.5 - 3.6	300kHz	471kHz	800kHz

Evaluation Board Information

The evaluation board size is 3 inches x 3 inches. It is a 4-layer board, containing 2-ounce copper on the top and bottom layers and 1-ounce copper on all internal layers. The board can be used as a 6A/10A reference design. Refer to the "Layout" section beginning on page 4. The board is made up of FR4 material and all components including the solder attachment are lead-free.

Thermal Considerations and Current Derating

Board layout is very critical in order to make the module operate safely and deliver maximum allowable power. To work in the high temperature environments and carry large currents, the board layout needs to be carefully designed to maximize thermal performance. To achieve this, select enough trace width, copper weight and the proper connectors.

This evaluation board is designed for running 6A/10A at room temperature without additional cooling systems needed. However, if the output voltage is increased or the board is operated at elevated temperatures, then the available current is derated. Refer to the derated current curves in the datasheets ([FN8422](#) and [FN7959](#)) to determine the output current available.

For layout of designs using the ZL9006M, ZL9010M, the thermal performance can be improved by adhering to the following design tips:

1. Use the top and bottom layers to carry the large current. VOUT, SW, PGND and VIN should have large, solid planes. Place enough thermal vias to connect the power planes in different layers under and around the module.
2. SW pad is switching node that generate switching noise. Keep the pad under the module. For noise-sensitive applications, it is recommended to keep SW pads only on the top and inner layers of the PCB; do not place SW pads exposed to the outside on the bottom layer of the PCB. To improve the thermal performance, the SW pads can be extended in the inner layer, as shown in SW pad on layer 3 (Figure 6). Make sure that layer 2 and layer 4 have the GND layers to cover the extended areas of phase pads at layer 3 to avoid noise coupling.
3. If the ambient temperature is high or the board space is limited, airflow is needed to dissipate more heat from the modules. A heat sink can also be applied to the top side of the module to further improve the thermal performance (heat sink recommendation: Aavid Thermalloy, part number 375224B00032G, www.aavid.com). Place the heat sink on the module's top surface on the power side that has the VIN and VOUT pads underneath.

ZL9006M, ZL9010M Board Schematic

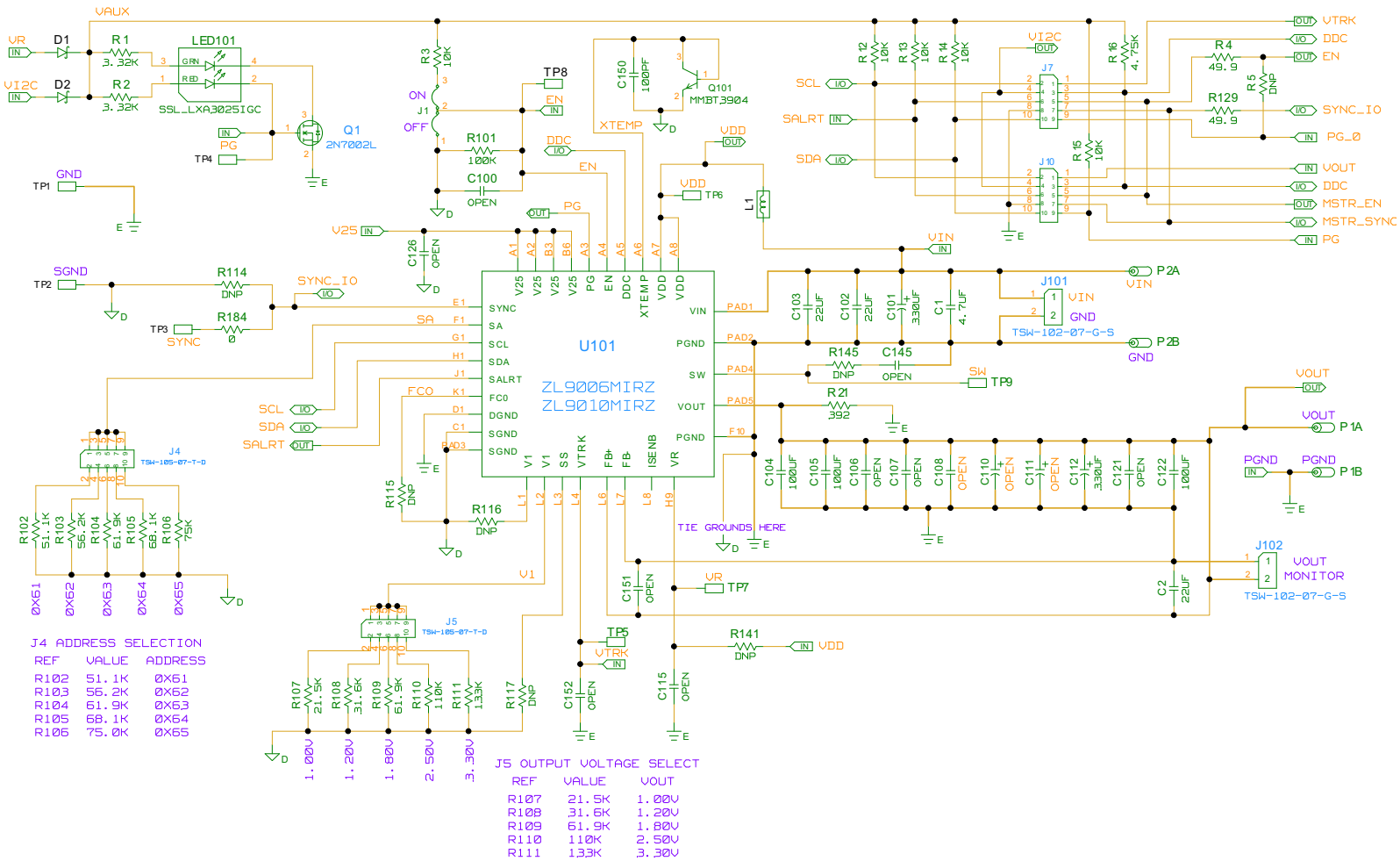

FIGURE 2. ZL9006M, ZL9010M BOARD SCHEMATIC

Layout

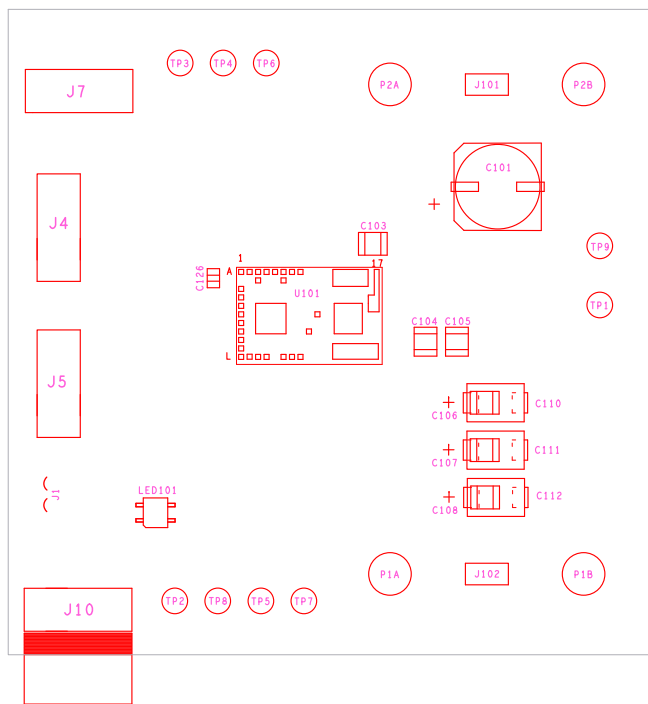

FIGURE 3. ASSEMBLY TOP

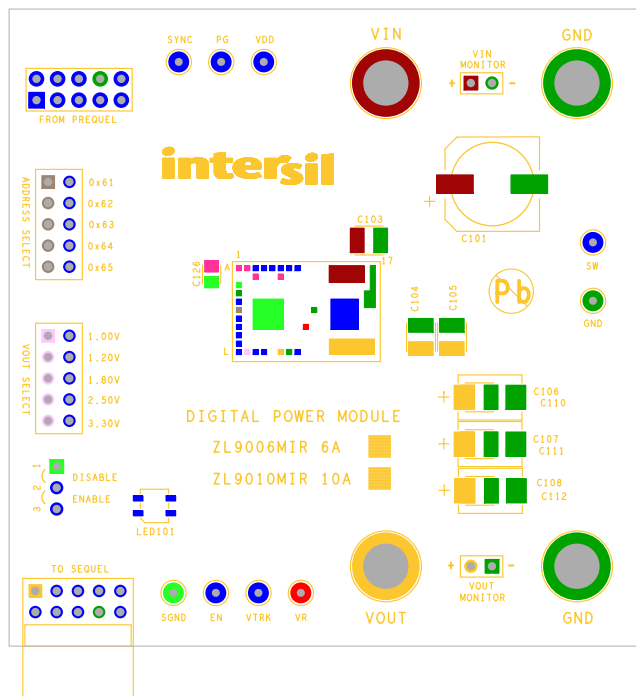

FIGURE 4. SILK SCREEN TOP

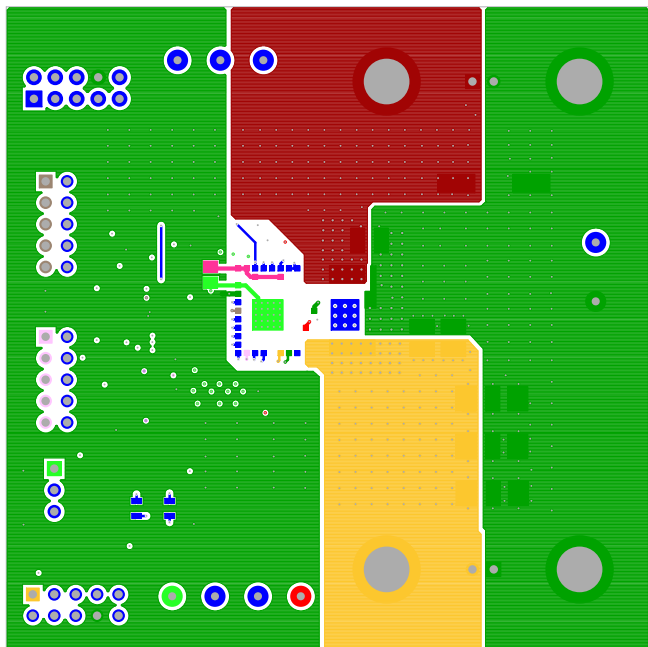

FIGURE 5. TOP LAYER COMPONENT SIDE

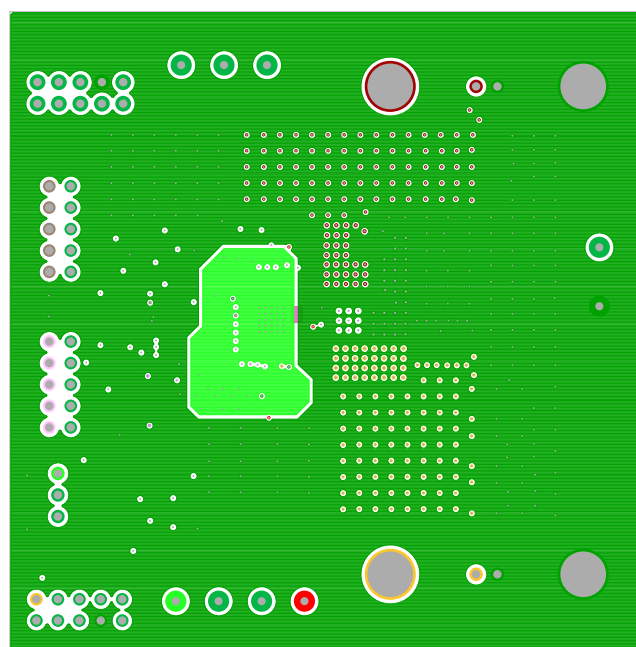

FIGURE 6. LAYER 2

Layout (Continued)

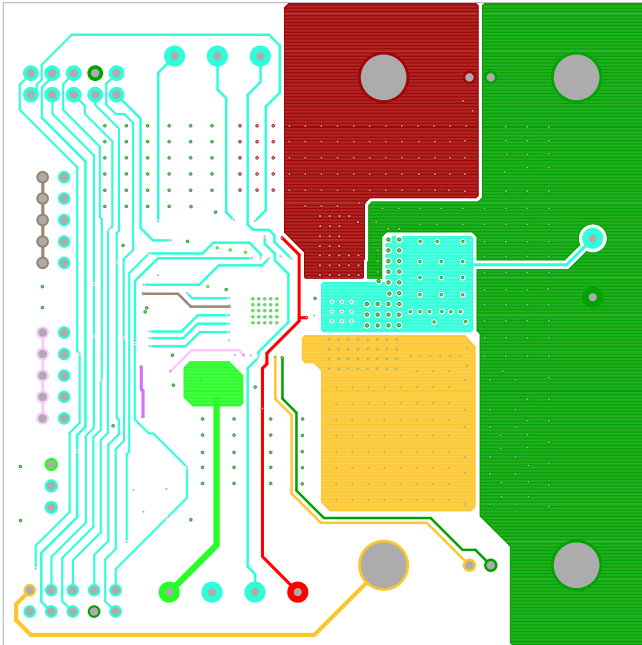

FIGURE 7. LAYER 3

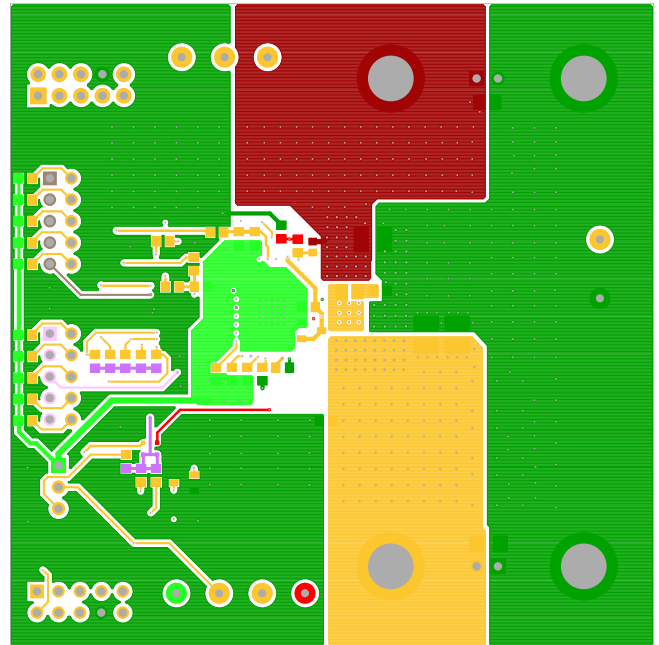

FIGURE 8. BOTTOM LAYER SOLDER SIDE

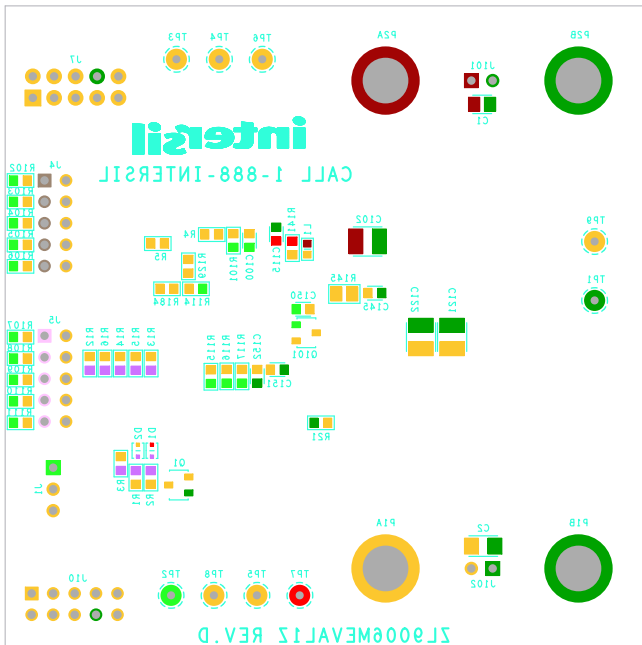

FIGURE 9. SILK SCREEN BOTTOM

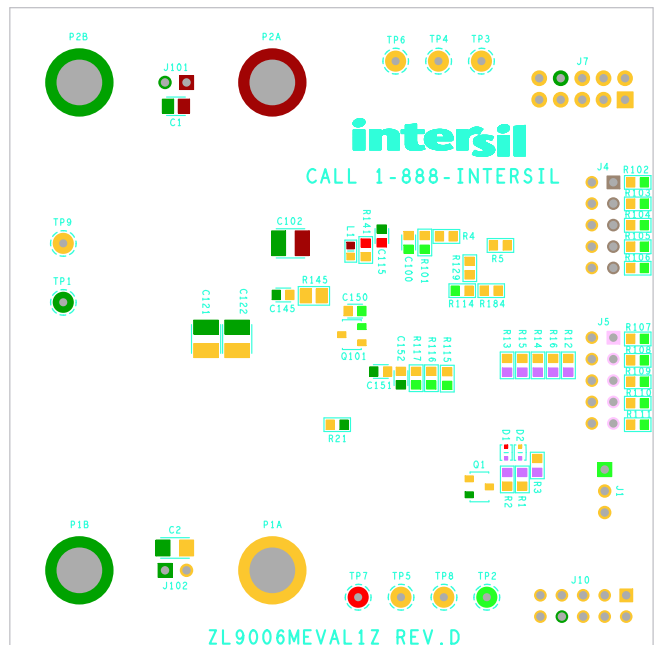

FIGURE 10. SILK SCREEN BOTTOM (MIRRORED)

Layout (Continued)

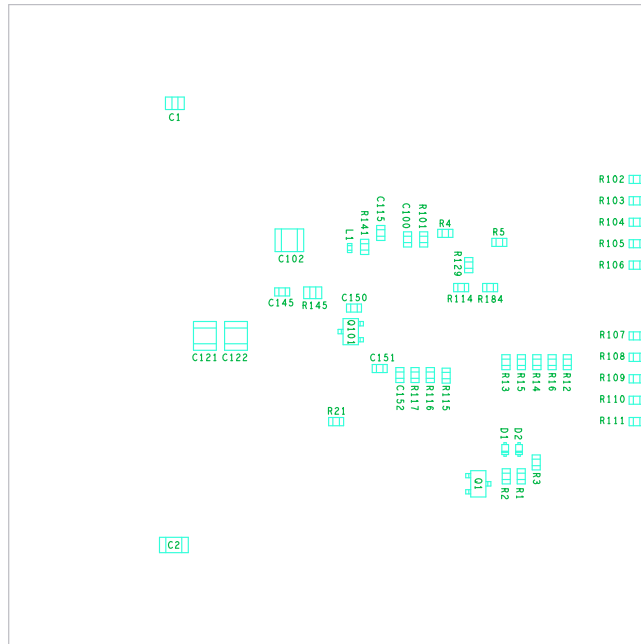

FIGURE 11. ASSEMBLY BOTTOM

Bill of Materials

PART NUMBER	QTY	REF DES	MANUFACTURER	DESCRIPTION
12066C226KAT2A	1	C2	AVX	Ceramic Capacitor
2N7002L	1	Q1	On Semi	N-Channel 60V 115mA MOSFET
5002	9	TP1-TP9	Keystone	Miniature White Test Point 0.100 Pad 0.040 Thole
575-4	4	P1A, P1B, P2A, P2B	Keystone	Solder Mount Banana Plug
6TPF330M9L	1	C112	Sanyo-Poscap	TPF Series Low Esr Products Capacitor
APXA160ARA331MJCOG	1	C101	Nippon	AL Polymer PXA Series Capacitor (RoHS Comp.)
BAT54XV2T1	2	D1, D2	On-semi	30V 200mW Schottky Barrier Diode
BLM15BD102SN1D	1	L1	Murata	Chip Ferrite Bead
GRM21BR71C475KA73L	1	C1	Murata	Ceramic Capacitor
GRM32ER61E226KE15L	2	C102, C103	Murata	Ceramic Chip Capacitor
H1045-00101-50V5	1	C150	Generic	Multilayer Capacitor
H1045-OPEN	5	C100, C115, C145, C151, C152	Generic	Multilayer Capacitor
H1046-OPEN	1	C126	Generic	Multilayer Capacitor
H1082-00107-6R3V20	4	C104, C105, C108, C122	Generic	Ceramic Chip Capacitor
H1082-OPEN	3	C106, C107, C121	Generic	Ceramic Chip Capacitor
H2505-DNP-DNP-1	6	R5, R114-R117, R141	Generic	Metal Film Chip Resistor (Do Not Populate)
H2506-DNP-DNP-1	1	R145	Generic	Metal Film Chip Resistor (Do Not Populate)
H2511-00R00-1/16W1	1	R184	Generic	Thick Film Chip Resistor
H2511-01002-1/16W1	5	R3, R12-R15	Generic	Thick Film Chip Resistor
H2511-01003-1/16W1	1	R101	Generic	Thick Film Chip Resistor
H2511-01103-1/16W1	1	R110	Generic	Thick Film Chip Resistor
H2511-01333-1/16W1	1	R111	Generic	Thick Film Chip Resistor
H2511-02152-1/16W1	1	R107	Generic	Thick Film Chip Resistor
H2511-03162-1/16W1	1	R108	Generic	Thick Film Chip Resistor
H2511-03321-1/16W1	2	R1, R2	Generic	Thick Film Chip Resistor
H2511-03920-1/16W1	1	R21	Generic	Thick Film Chip Resistor
H2511-04751-1/16W1	1	R16	Generic	Thick Film Chip Resistor
H2511-049R9-1/16W1	2	R4, R129	Generic	Thick Film Chip Resistor
H2511-05112-1/16W1	1	R102	Generic	Thick Film Chip Resistor

Bill of Materials (Continued)

PART NUMBER	QTY	REF DES	MANUFACTURER	DESCRIPTION
H2511-05622-1/16W1	1	R103	Generic	Thick Film Chip Resistor
H2511-06192-1/16W1	2	R104, R109	Generic	Thick Film Chip Resistor
H2511-06812-1/16W1	1	R105	Generic	Thick Film Chip Resistor
H2511-07502-1/16W1	1	R106	Generic	Thick Film Chip Resistor
JUMPER-3-100	1	J1	Generic	Three Pin Jumper
MMBT3904	1	Q101	Micro Commercial Components	NPN General Purpose Amplifier
SSL-LXA3025IGC	1	LED101	Lumex	3mm x 2.5mm Surface Mount Red/Green LED
SSQ-105-02-T-D-RA	1	J10	Samtec	10 Pin Socket 2.54mm x 2.54mm (0.100) Right Angle
TSW-102-07-G-S	2	J101, J102	Samtec	2 Pin Header 2.54mm (0.100) Pitch
TSW-105-07-T-D	2	J4, J5	Samtec	10 Pin Header 2.54mm x 2.54mm (0.100)
TSW-136-10	1	J7	Samtec	10 Pin Header 2.54mm x 2.54mm (0.100)
ZL9006MIRZ or ZL9010MIRZ	1	U101	Intersil	Digital DC/DC PMBus 6A/10A Power Module

ZL9006M, ZL9010M Efficiency Curves

Test conditions: room temperature and no air flow.

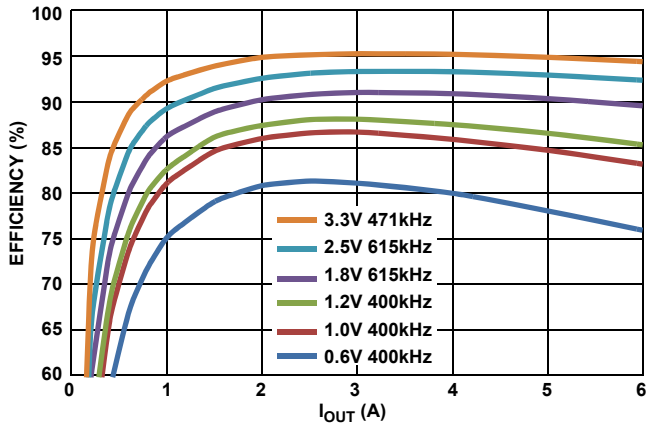

FIGURE 12. ZL9006M EFFICIENCY, $V_{IN} = 5V$

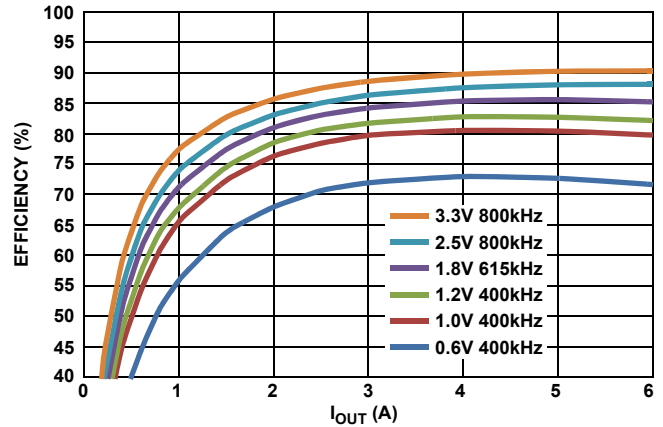

FIGURE 13. ZL9006M EFFICIENCY, $V_{IN} = 12V$

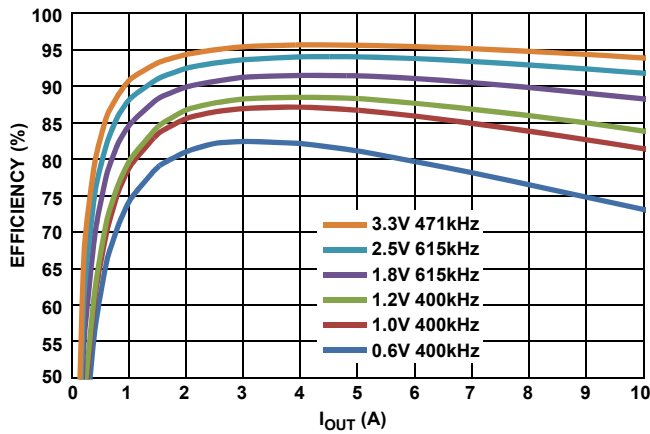

FIGURE 14. ZL9010M EFFICIENCY, $V_{IN} = 5V$

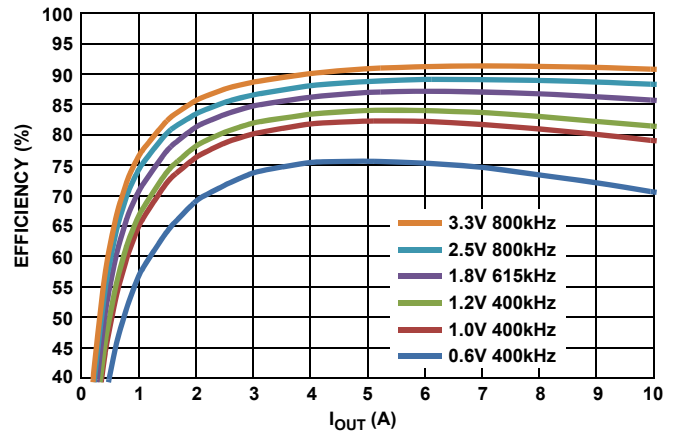

FIGURE 15. ZL9010M EFFICIENCY, $V_{IN} = 12V$

Notice

1. Descriptions of circuits, software and other related information in this document are provided only to illustrate the operation of semiconductor products and application examples. You are fully responsible for the incorporation or any other use of the circuits, software, and information in the design of your product or system. Renesas Electronics disclaims any and all liability for any losses and damages incurred by you or third parties arising from the use of these circuits, software, or information.
2. Renesas Electronics hereby expressly disclaims any warranties against and liability for infringement or any other claims involving patents, copyrights, or other intellectual property rights of third parties, by or arising from the use of Renesas Electronics products or technical information described in this document, including but not limited to, the product data, drawings, charts, programs, algorithms, and application examples.
3. No license, express, implied or otherwise, is granted hereby under any patents, copyrights or other intellectual property rights of Renesas Electronics or others.
4. You shall not alter, modify, copy, or reverse engineer any Renesas Electronics product, whether in whole or in part. Renesas Electronics disclaims any and all liability for any losses or damages incurred by you or third parties arising from such alteration, modification, copying or reverse engineering.
5. Renesas Electronics products are classified according to the following two quality grades: "Standard" and "High Quality". The intended applications for each Renesas Electronics product depends on the product's quality grade, as indicated below.
"Standard": Computers; office equipment; communications equipment; test and measurement equipment; audio and visual equipment; home electronic appliances; machine tools; personal electronic equipment; industrial robots; etc.
"High Quality": Transportation equipment (automobiles, trains, ships, etc.); traffic control (traffic lights); large-scale communication equipment; key financial terminal systems; safety control equipment; etc.
Unless expressly designated as a high reliability product or a product for harsh environments in a Renesas Electronics data sheet or other Renesas Electronics document, Renesas Electronics products are not intended or authorized for use in products or systems that may pose a direct threat to human life or bodily injury (artificial life support devices or systems; surgical implantations; etc.), or may cause serious property damage (space system; undersea repeaters; nuclear power control systems; aircraft control systems; key plant systems; military equipment; etc.). Renesas Electronics disclaims any and all liability for any damages or losses incurred by you or any third parties arising from the use of any Renesas Electronics product that is inconsistent with any Renesas Electronics data sheet, user's manual or other Renesas Electronics document.
6. When using Renesas Electronics products, refer to the latest product information (data sheets, user's manuals, application notes, "General Notes for Handling and Using Semiconductor Devices" in the reliability handbook, etc.), and ensure that usage conditions are within the ranges specified by Renesas Electronics with respect to maximum ratings, operating power supply voltage range, heat dissipation characteristics, installation, etc. Renesas Electronics disclaims any and all liability for any malfunctions, failure or accident arising out of the use of Renesas Electronics products outside of such specified ranges.
7. Although Renesas Electronics endeavors to improve the quality and reliability of Renesas Electronics products, semiconductor products have specific characteristics, such as the occurrence of failure at a certain rate and malfunctions under certain use conditions. Unless designated as a high reliability product or a product for harsh environments in a Renesas Electronics data sheet or other Renesas Electronics document, Renesas Electronics products are not subject to radiation resistance design. You are responsible for implementing safety measures to guard against the possibility of bodily injury, injury or damage caused by fire, and/or danger to the public in the event of a failure or malfunction of Renesas Electronics products, such as safety design for hardware and software, including but not limited to redundancy, fire control and malfunction prevention, appropriate treatment for aging degradation or any other appropriate measures. Because the evaluation of microcomputer software alone is very difficult and impractical, you are responsible for evaluating the safety of the final products or systems manufactured by you.
8. Please contact a Renesas Electronics sales office for details as to environmental matters such as the environmental compatibility of each Renesas Electronics product. You are responsible for carefully and sufficiently investigating applicable laws and regulations that regulate the inclusion or use of controlled substances, including without limitation, the EU RoHS Directive, and using Renesas Electronics products in compliance with all these applicable laws and regulations. Renesas Electronics disclaims any and all liability for damages or losses occurring as a result of your noncompliance with applicable laws and regulations.
9. Renesas Electronics products and technologies shall not be used for or incorporated into any products or systems whose manufacture, use, or sale is prohibited under any applicable domestic or foreign laws or regulations. You shall comply with any applicable export control laws and regulations promulgated and administered by the governments of any countries asserting jurisdiction over the parties or transactions.
10. It is the responsibility of the buyer or distributor of Renesas Electronics products, or any other party who distributes, disposes of, or otherwise sells or transfers the product to a third party, to notify such third party in advance of the contents and conditions set forth in this document.
11. This document shall not be reprinted, reproduced or duplicated in any form, in whole or in part, without prior written consent of Renesas Electronics.
12. Please contact a Renesas Electronics sales office if you have any questions regarding the information contained in this document or Renesas Electronics products.
(Note 1) "Renesas Electronics" as used in this document means Renesas Electronics Corporation and also includes its directly or indirectly controlled subsidiaries.
(Note 2) "Renesas Electronics product(s)" means any product developed or manufactured by or for Renesas Electronics.

(Rev.4.0-1 November 2017)



SALES OFFICES

Renesas Electronics Corporation

<http://www.renesas.com>

Refer to "<http://www.renesas.com/>" for the latest and detailed information.

Renesas Electronics America Inc.
1001 Murphy Ranch Road, Milpitas, CA 95035, U.S.A.
Tel: +1-408-432-8888, Fax: +1-408-434-5351

Renesas Electronics Canada Limited
9251 Yonge Street, Suite 8309 Richmond Hill, Ontario Canada L4C 9T3
Tel: +1-905-237-2004

Renesas Electronics Europe Limited
Dukes Meadow, Millboard Road, Bourne End, Buckinghamshire, SL8 5FH, U.K
Tel: +44-1628-651-700, Fax: +44-1628-651-804

Renesas Electronics Europe GmbH
Arcadiastrasse 10, 40472 Düsseldorf, Germany
Tel: +49-211-6503-0, Fax: +49-211-6503-1327

Renesas Electronics (China) Co., Ltd.
Room 1709 Quantum Plaza, No.27 ZhichunLu, Haidian District, Beijing, 100191 P. R. China
Tel: +86-10-8235-1155, Fax: +86-10-8235-7679

Renesas Electronics (Shanghai) Co., Ltd.
Unit 301, Tower A, Central Towers, 555 Langao Road, Putuo District, Shanghai, 200333 P. R. China
Tel: +86-21-2226-0888, Fax: +86-21-2226-0999

Renesas Electronics Hong Kong Limited
Unit 1601-1611, 16/F., Tower 2, Grand Century Place, 193 Prince Edward Road West, Mongkok, Kowloon, Hong Kong
Tel: +852-2265-6688, Fax: +852-2886-9022

Renesas Electronics Taiwan Co., Ltd.
13F, No. 363, Fu Shing North Road, Taipei 10543, Taiwan
Tel: +886-2-8175-9600, Fax: +886-2-8175-9670

Renesas Electronics Singapore Pte. Ltd.
80 Bendemeer Road, Unit #06-02 Hyflux Innovation Centre, Singapore 339949
Tel: +65-6213-0200, Fax: +65-6213-0300

Renesas Electronics Malaysia Sdn.Bhd.
Unit 1207, Block B, Menara Amcorp, Amcorp Trade Centre, No. 18, Jln Persiaran Barat, 46050 Petaling Jaya, Selangor Darul Ehsan, Malaysia
Tel: +60-3-7955-9390, Fax: +60-3-7955-9510

Renesas Electronics India Pvt. Ltd.
No.777C, 100 Feet Road, HAL 2nd Stage, Indiranagar, Bangalore 560 038, India
Tel: +91-80-67208700, Fax: +91-80-67208777

Renesas Electronics Korea Co., Ltd.
17F, KAMCO Yangjae Tower, 262, Gangnam-daero, Gangnam-gu, Seoul, 06265 Korea
Tel: +82-2-558-3737, Fax: +82-2-558-5338