

## ZL8801-2PH-DEMO1Z

### Demonstration Board User Guide

UG005  
Rev 0.00  
September 25, 2014

The ZL8801 is a digital power conversion and management IC that combines an efficient step-down DC/DC converter with key power and thermal management functions in a single package. The ZL8801 incorporates a fully digital, compensation-free, ChargeMode™ control to achieve single-cycle transient response.

The ZL8801-2PH-DEMO1Z demonstration board is a 6-layer board demonstrating a 2-phase 80A synchronous buck converter. Sequencing, margining, plus other features can be evaluated using this demonstration board.

An USB-to-PMBus™ adapter board (ZLUSBEVAL3Z, included with the demonstration kit) is used to connect the demonstration board to a PC. Intersil's PowerNavigator™ evaluation software can then be used to evaluate the full PMBus functionality of the part using a PC running Microsoft Windows XP, 7 or 8.

## Key Features

- 2-phase 80A synchronous buck converter with compensation-free ChargeMode control
- Designed to be easy to use and modify. Optimized for small circuit footprint and dynamic response
- Configurable through PMBus
- $V_{IN}$  range of 4.5V to 14V,  $V_{OUT}$  adjustable from 0.54 to 2.0V (Device can be adjusted to 5.5V with 6.3V output capacitors)
- Enable switch and power-good indicator

## Specifications

- $V_{IN} = 12V$
- $V_{OUT} = 1.2V/80A$  max
- $f_{SW} = 500kHz$
- Efficiency: 91% at 40A
- Output ripple:  $\pm 1\%$
- Dynamic response:  $\pm 1\%$  (50% to 100% to 50% load step,  $di/dt = 10A/\mu s$ )
- Board temperature:  $+25^{\circ}C$

## References

[ZL8801](#) datasheet

[ISL99140](#) datasheet

[Digital Power Design Center](#)

[AN1900](#), "USB to PMBus™ Adapter"

## Ordering Information

PART NUMBER	DESCRIPTION
ZL8801-2PH-DEMO1Z	ZL8801 Demonstration Kit (Evaluation Board, USB Adapter, Cable)

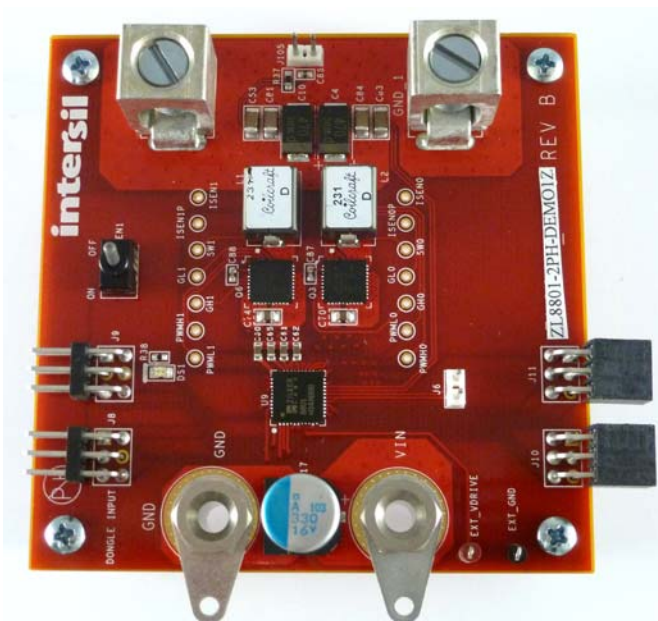

FIGURE 1. TOP VIEW

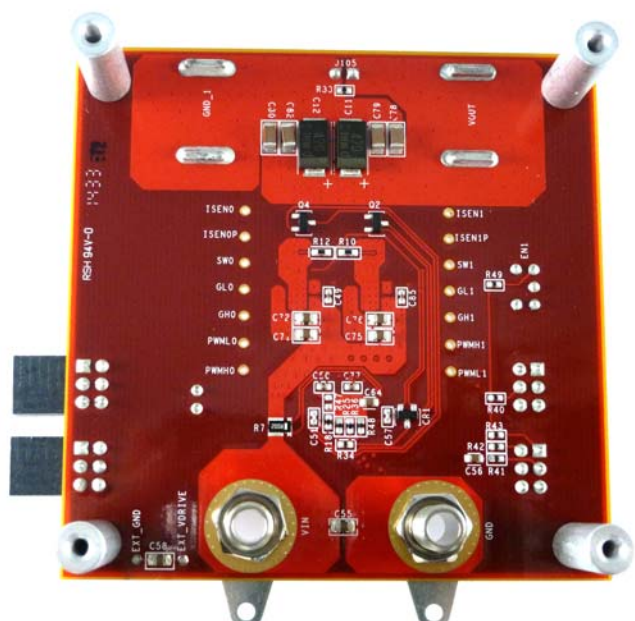

FIGURE 2. BOTTOM VIEW

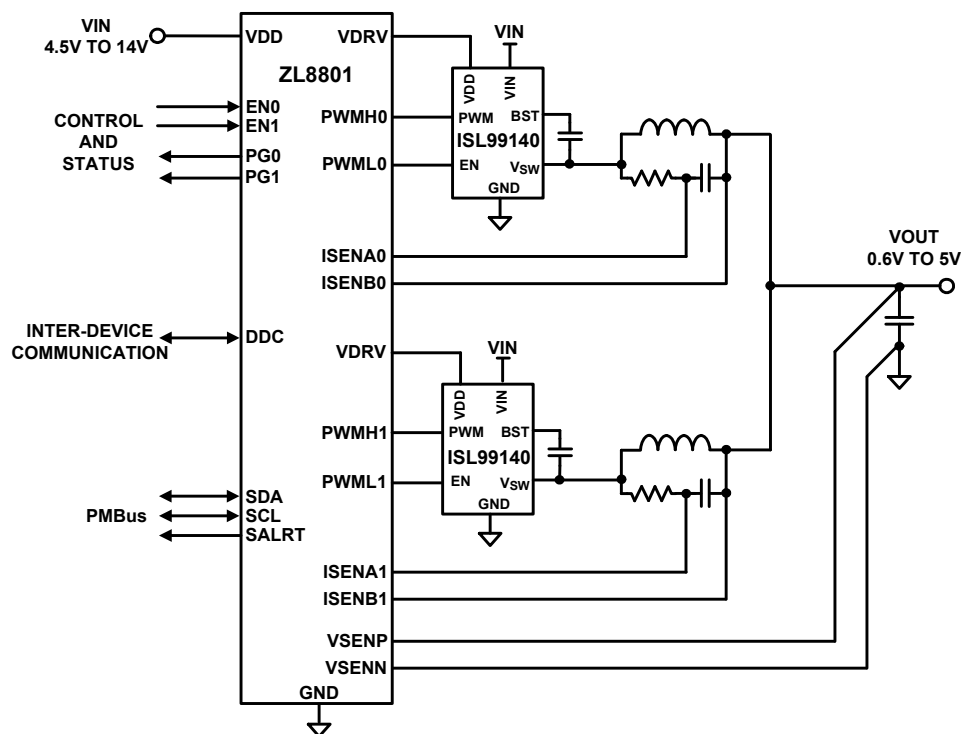

FIGURE 3. ZL8801-2PH-DEMO1Z SIMPLIFIED SCHEMATIC

## Functional Description

The ZL8801-2PH-DEMO1Z provides all circuitry required to demonstrate the features of the ZL8801. The ZL8801-2PH-DEMO1Z has a functionally-optimized ZL8801 circuit layout that allows efficient operation up to the maximum output current.

A majority of the features of the ZL8801, such as compensation-free ChargeMode control, soft-start delay and ramp times, supply sequencing, voltage tracking and voltage margining are available on this demonstration board. For voltage tracking and sequencing demonstration, the board can be connected to any other Intersil demonstration board that supports the Digital-DC™ (DDC) bus.

[Figure 3](#) shows a simplified schematic diagram of the ZL8801-2PH-DEMO1Z board.

The hardware enable function is controlled by a toggle switch on the ZL8801-2PH-DEMO1Z board. The power-good (PG) LEDs indicate the correct state of PG when external power is applied to the ZL8801-2PH-DEMO1Z board. The right angle headers at opposite ends of the board are for connecting a USB to PMBus adapter board or for daisy chaining multiple demonstration boards together to build multi-output configurations.

[“ZL8801-2PH-DEMO1Z Schematic”](#) on [page 4](#) shows the detailed demonstration circuit. [Figures 5](#) through [11](#) show typical performance data and [Figures 16](#) through [23](#) show the PCB board layout. The default configuration file is given on [page 6](#), and the Bill of Materials (BOM) is included for reference beginning on [page 5](#).

## Operation

### PMBus Operation

The ZL8801 utilizes the PMBus protocol. The PMBus functionality can be controlled via USB from a PC running the PowerNavigator evaluation software in Windows XP, 7 or 8 operating systems.

Install the evaluation software from the following Intersil website:

<http://www.intersil.com/powernavigator>

For board operation, connect the included USB-to-PMBus adapter board to J8 of the ZL8801-2PH-DEMO1Z board labeled “DONGLE”. Connect the desired load and an appropriate power supply to the input and connect the included USB cable to the PC running the PowerNavigator evaluation software. Place the ENABLE switches in “DISABLE” and turn on the power.

The evaluation software allows modification of all ZL8801 PMBus parameters. The ZL8801 device on the board has been pre-configured as described in this document, but the user may modify the operating parameters through the evaluation software or by loading a predefined set-up from a configuration file.

The ENABLE switch can then be moved to “ENABLE” and the ZL8801-2PH-DEMO1Z board can be tested. Alternately, the PMBus ON\_OFF\_CONFIG and OPERATION commands may be used from the PowerNavigator GUI.

## Quick Start Guide

### Stand Alone Operation

1. Set ENABLE switch to "DISABLE".
2. Apply load to VOUT0 and/or VOUT1.
3. Connect the USB to PMBus adapter board to J8 (labeled "DONGLE") of ZL8801-2PH-DEMO1Z.
4. Connect supplied USB cable from computer to USB to PMBus adapter board.
5. Connect power supply to VIN (supply turned off).
6. Turn power supply on.
7. Set ENABLE switch to "ENABLE".
8. Monitor ZL8801-2PH-DEMO1Z board operation using an oscilloscope.

### USB (PMBus) Operation

1. Set ENABLE switch to "DISABLE".
2. Apply load to VOUT and/or VOUT1.
3. Connect power supply to VIN (supply turned off).
4. Turn power supply on.
5. Connect USB to PMBus adapter board to J8 of ZL8801-2PH-DEMO1Z.
6. Connect supplied USB cable from computer to USB to PMBus adapter board.

Install the PowerNavigator evaluation software from the following Intersil website:

<http://www.intersil.com/powernavigator>

7. Set ENABLE switch to "ENABLE".
8. Monitor and configure the ZL8801-2PH-DEMO1Z board using PMBus commands in the evaluation software.
9. Test the ZL8801-2PH-DEMO1Z operation using an oscilloscope and the evaluation software.

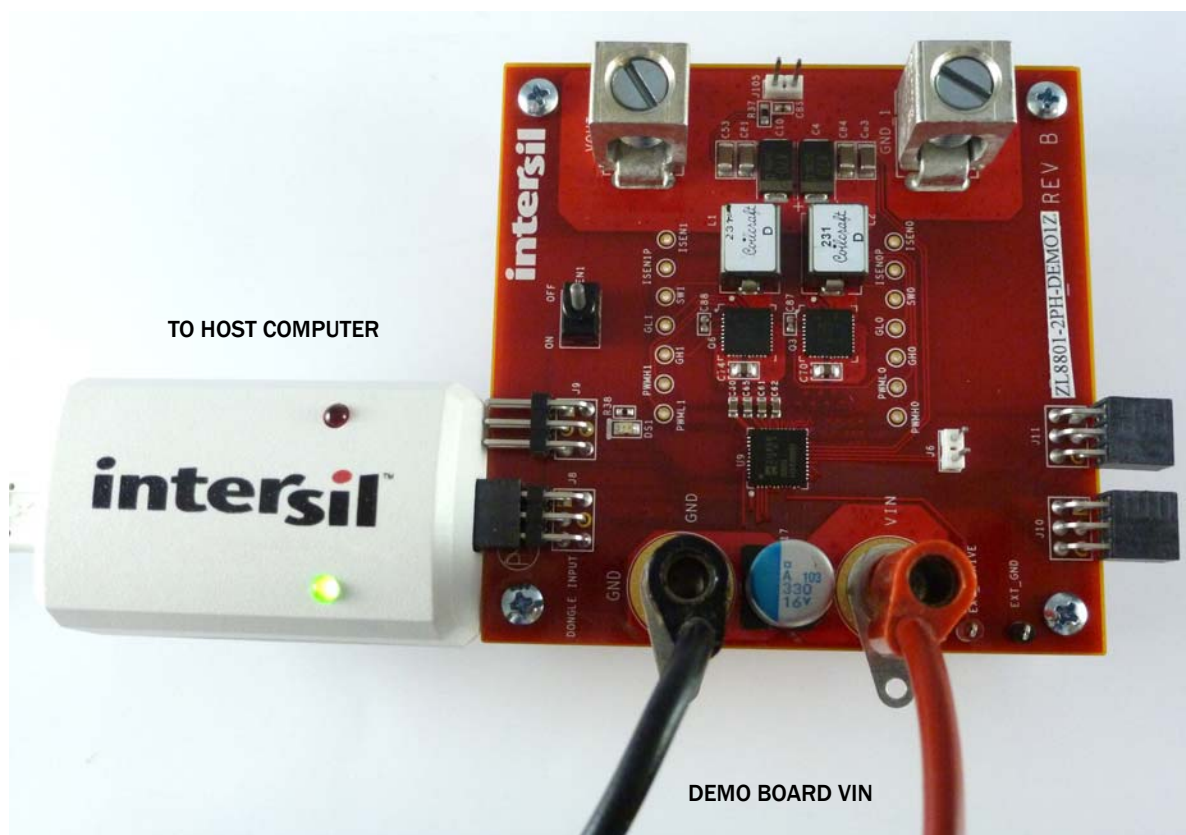
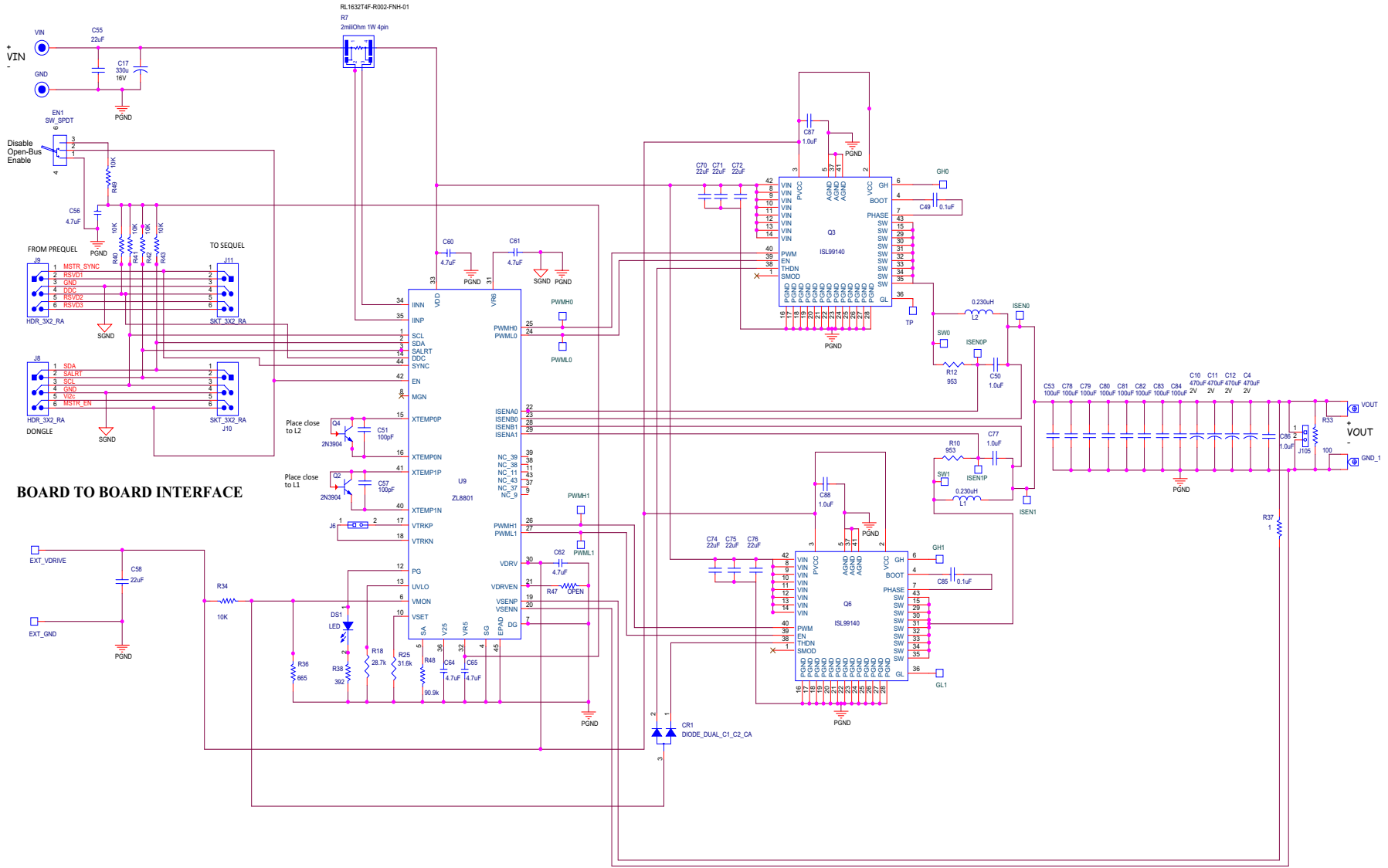

FIGURE 4. ZL8801 DEMONSTRATION KIT SET-UP

# ZL8801-2PH-DEMO1Z Schematic



## BOARD TO BOARD INTERFACE

## Bill of Materials

QTY	REFERENCE DESIGNATOR	DESCRIPTION	PCB FOOTPRINT	MANUFACTURER	PART NUMBER
1	U9	ZL8801	QFN44_275X275	Intersil	ZL8801
2	Q3, Q6	ISL99140	QFN40_236X236	Intersil	ISL99140
1	CR1	BAT54A-T	SOT23	NXP Semiconductor	BAT54A, 215
4	C4, C10, C11, C12	470µF/2V	CAP_7343	Panasonic	EEF-SX0D471E4
1	C17	330µF	CAPAE_315X244	United Chemi-Con	APXA160ARA331MJCOG
2	C49, C85	0.1µF/16V/X7R	sm0402	TDK	C1005X7R1C104K050BC
5	C50, C77, C86, C87, C88	1.0µF/6.3V/X5R	sm0402	TDK	C1005X7S1A105K050BC
2	C51, C57	100pF/50V/COG-NPO	sm0402	TDK	C1005C0G1H101K050BA
8	C53, C78, C79, C80, C81, C82, C83, C84	100µF/6.3V/X5R	sm1206	TDK	C3216X5R0J107M160AB
8	C55, C58, C70, C71, C72, C74, C75, C76	22µF/16V/X5R	sm0805	TDK	C2012X5R1C226M085AC
6	C56, C60, C61, C62, C64, C65	4.7µF/16V/X5R	CAP_0603	TDK	C1608X5R1C475K080AC
2	L1, L2	0.230µH	IND_PA0511	Coil Craft	SLC1175-231ME_
2	Q2, Q4	2N3904	SOT23	On Semiconductor	MMBT3904LT1G
1	R7	2mΩ 1W 4pin	RL1632T4F	Cyntec	RL1632T4F-R002-F NH-01
2	R10, R12	953	SM0603	Panasonic	ERJ-3EKF9530V
1	R18	28.7k	SM0402	Panasonic	ERJ-2RKF2872X
1	R25	31.6k	SM0402	Panasonic	ERJ-2RKF3162X
1	R33	100	SM0402	Panasonic	ERJ-2RKF1000X
1	R36	665	SM0402	Panasonic	ERJ-2RKF6650X
1	R37	1	sm0603	Panasonic	ERJ-3RQF1R0V
1	R38	392	SM0402	Panasonic	ERJ-2RKF3920X
6	R40, R41, R42, R43, R49, R34	10k	SM0402	Panasonic	ERJ-2RKF1002X
0	R47	OPEN	SM0402	-	-
1	R48	90.9k	SM0402	Panasonic	ERJ-2RKF9092X
<b>DEMONSTRATION BOARD SPECIFIC AUXILIARY PARTS BILL OF MATERIALS</b>					
1	DS1	LED	sm0805	Chicago Miniature	CMD17-21VGC/TR8
1	EN1	SW_SPDT (3 position)	SW_GT13MCBE	C&K Components	GT13MCBE
1	EXT_VDRIVE	T POINT S RED	TP_41C60P	Keystone Electronics	5000
1	EXT_GND	T POINT S BLACK	TP_41C60P	Keystone Electronics	5001
2	VIN, GND	Banana_J	BAN-JACK	Emerson	108-0740-00
2	GND_1, VOUT	LUG	B2C-PCB	Lugs Direct	B2C-PCB
2	J6, J105	2 POS	CONN2	Samtec	TSW-102-07-L-S
2	J8, J9	HDR_3X2_RA	CONN6	Samtec	TSW-103-08-T-D-RA
2	J10, J11	SKT_3X2_RA	CONN6	Samtec	SSQ-103-02-T-D-RA

## Configuration File

The following text is loaded into the ZL8801 device on the ZL8801-2PH-DEMO1Z as default settings. Each PMBus command is loaded via the PowerNavigator software. The # symbol is used for a comment line.

```
# Initialize device to factory settings
```

```
RESTORE_FACTORY
STORE_DEFAULT_ALL
STORE_USER_ALL
```

```
### Begin Default Store
RESTORE_DEFAULT_ALL
```

```
ON_OFF_CONFIG      0x17
VOUT_MAX           0x4000      # 2 V
VOUT_COMMAND       0x2000      # 1 V
VOUT_MARGIN_HIGH   0x219a      # 1.05 V
VOUT_MARGIN_LOW    0x1e66      # 0.95 V
FREQUENCY_SWITCH   0xfbe8      # 500 kHz
VOUT_OV_FAULT_LIMIT 0x235c      # 1.105 V
VOUT_UV_FAULT_LIMIT 0x1ca4      # 0.895 V
IOUT_OC_FAULT_LIMIT 0xe320      # 50 A
IOUT_UC_FAULT_LIMIT 0xe4e0      # -50 A
POWER_GOOD_ON      0x1ccd      # 0.9 V
IOUT0_CAL_GAIN     0xb11e      # 0.279 mV/A
IOUT1_CAL_GAIN     0xb11e      # 0.279 mV/A
USER_CONFIG        0x2686
IIN_CAL_GAIN       0xc300      # 3 mV/A
DDC_CONFIG         0xa01
POWER_GOOD_DELAY   0xca00      # 4 ms
INDUCTOR           0xb0eb      # 0.229 uH
TEMPCO_CONFIG      0xa7
DEADTIME_CONFIG    0x8888
ASCR_CONFIG        0x015a0190
SEQUENCE           0x0
DDC_GROUP          0x2fc00000
IOUT_AVG_OC_FAULT_LIMIT 0xe230      # 35 A
IOUT_AVG_UC_FAULT_LIMIT 0xe5d0      # -35 A
MFR_VMON_OV_FAULT_LIMIT 0xcb00      # 6 V
```

```
STORE_DEFAULT_ALL
### End Default Store
```

## PCB Layout Guidelines

For best performance with the ZL8801, please use the following layout guidelines:

- SGND is the analog reference for VDD, VR6, VR5 and V25 and all pin-strap pins. It should connect to the system ground on internal PCB layers. The ZL8801 paddle should then connect to SGND with multiple vias for electrical and thermal relief.
- DGND is the digital GND return path for the controller. It should connect to the SGND shape using a single point, low impedance connection.
- The VDD pin is the input supply pin for the ZL8801, and is also used for  $V_{IN}$  telemetry. The VR6, VR5 and V25 pins are outputs of regulators used to bias internal circuitry. Ceramic decoupling capacitors on these pins should be placed close to their respective pin with a tight connection to SGND.
- The voltage sense lines should be routed differentially from the regulation point back to the ZL8801. Be sure to avoid any noisy areas when routing (such as the switch node) for best performance.
- The current sense traces used for DCR sensing need to connect to the inductor pads using a kelvin connection. This minimizes stray PCB resistance in the current sense network, maximizing current sense accuracy. The resistor in the RC current sense network can be placed by the output inductor, but the capacitor should be placed by the controller.
- The XTEMPxP and XTEMPxN signals should be routed as a differential pair from the external NPN sensor back to the controller, avoiding any noisy areas on the PCB. Up to a 100pF capacitor can be placed across these pins for noise filtering.
- Ceramic input caps for the power stage need to be placed close to the ISL99140 input pins, with a tight loop between the ISL99140 VIN and PGND connections. The ceramic decoupling capacitor for the ISL99140 VCC and PVCC pins should be placed close to those pins.
- Please see the ZL8801 datasheet for guidance on component selection, including input capacitors, output capacitors, and the output inductor.

## Measured Data

The following data was acquired using a ZL8801-2PH-DEMO1Z demonstration board.

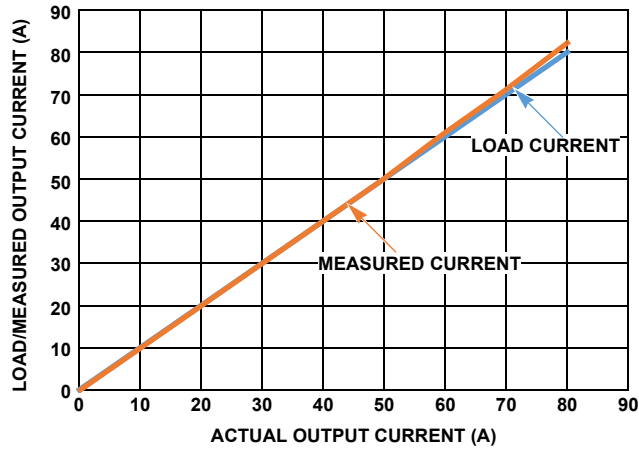

FIGURE 5. OUTPUT CURRENT MEASUREMENT ACCURACY (SINGLE-PHASE)

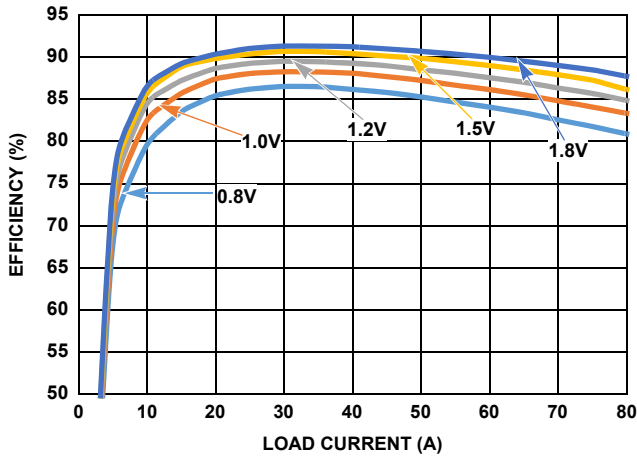

FIGURE 6. EFFICIENCY,  $V_{IN} = 12V$ ,  $f_{SW} = 300kHz$

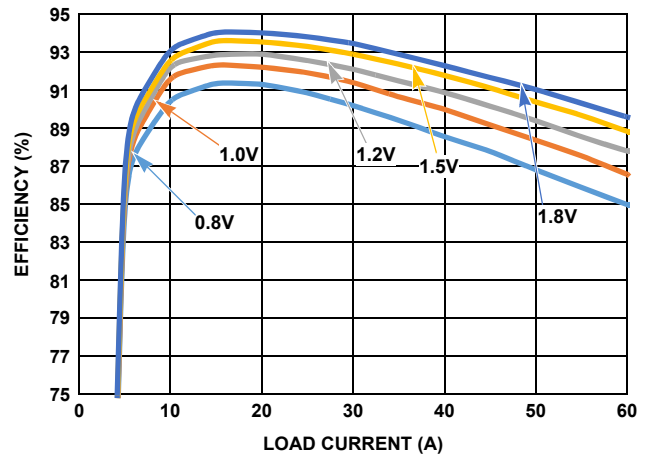

FIGURE 7. EFFICIENCY,  $V_{IN} = 5V$ ,  $f_{SW} = 300kHz$

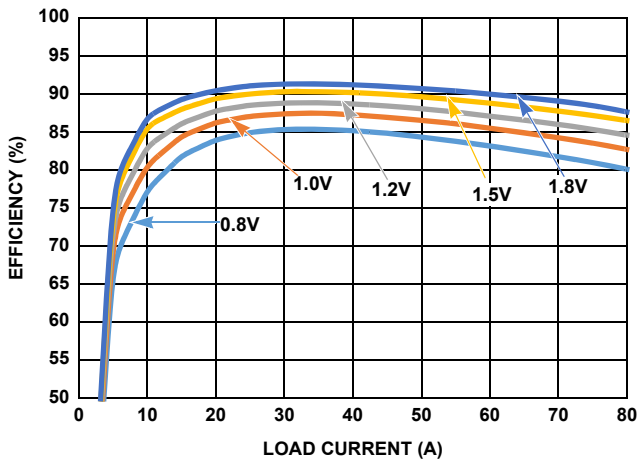

FIGURE 8. EFFICIENCY,  $V_{IN} = 12V$ ,  $f_{SW} = 400kHz$

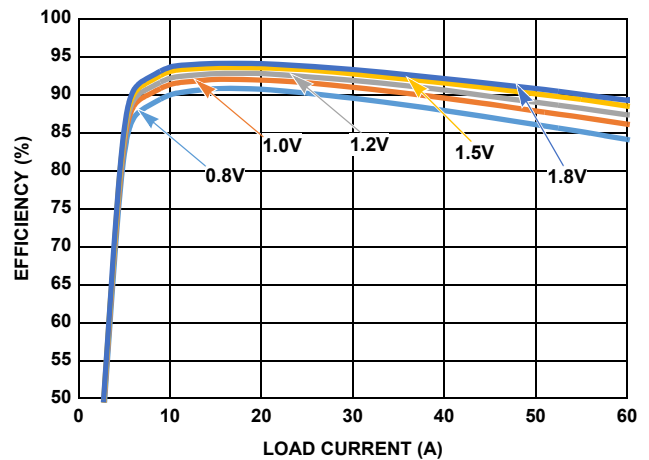

FIGURE 9. EFFICIENCY,  $V_{IN} = 5V$ ,  $f_{SW} = 400kHz$

**Measured Data** The following data was acquired using a ZL8801-2PH-DEMO1Z demonstration board. (Continued)

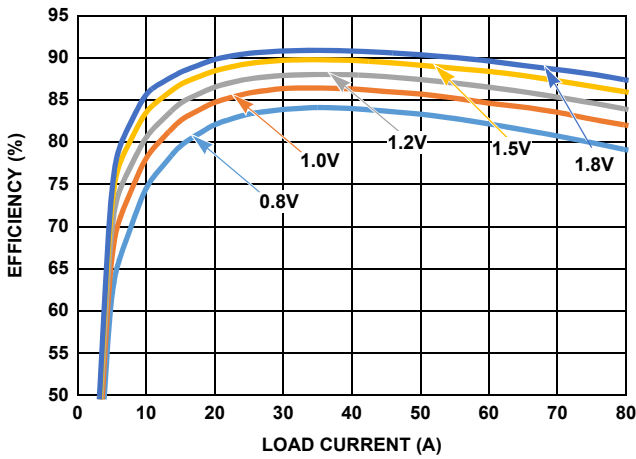

FIGURE 10. EFFICIENCY,  $V_{IN} = 12V$ ,  $f_{SW} = 516kHz$

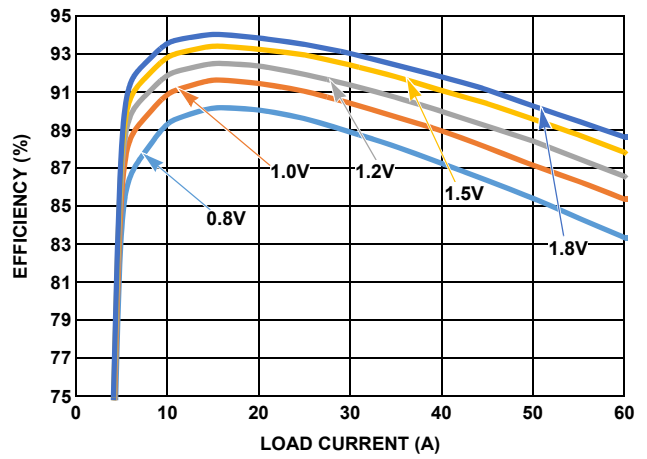

FIGURE 11. EFFICIENCY,  $V_{IN} = 5V$ ,  $f_{SW} = 516kHz$



FIGURE 12. RAMP UP

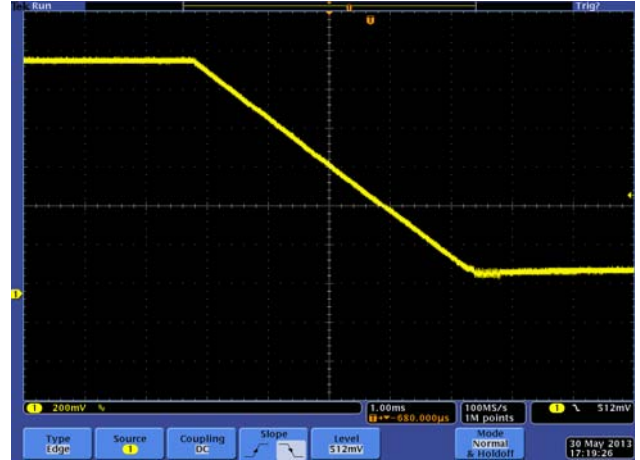

FIGURE 13. RAMP DOWN

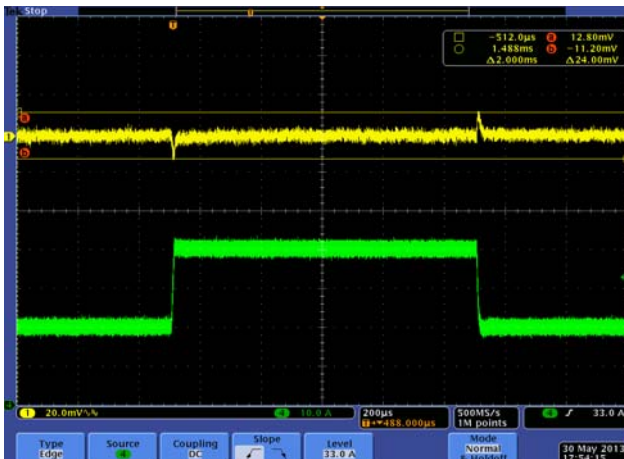

FIGURE 14. STEP RESPONSE, 20A TO 40A AT 5A/ $\mu$ s, ASCR = 1200  
TOTAL DEVIATION WINDOW 25mV = 2.5%

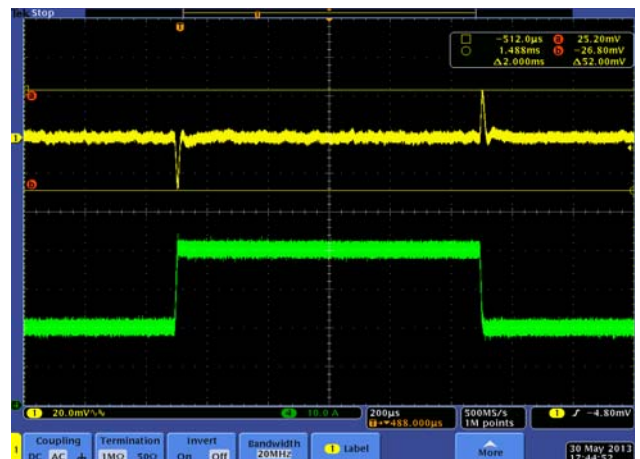

FIGURE 15. STEP RESPONSE, 20A TO 40A AT 5A/ $\mu$ s, ASCR = 400  
TOTAL DEVIATION WINDOW 50mV = 5%



# ZL8801-2PH-DEMO1Z Board Layout

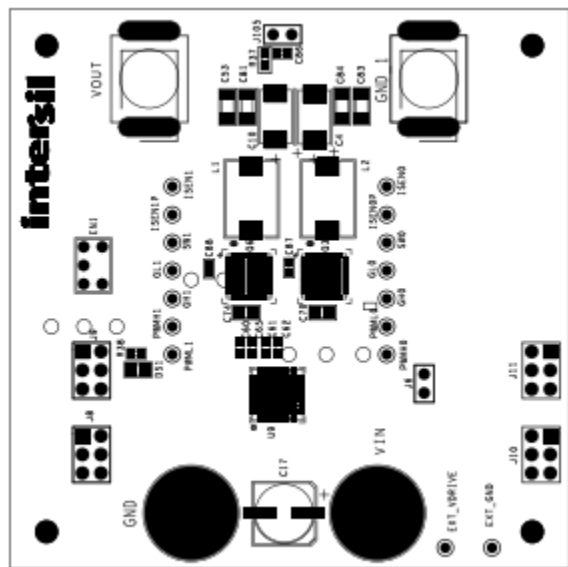

FIGURE 16. PCB - TOP ASSEMBLY

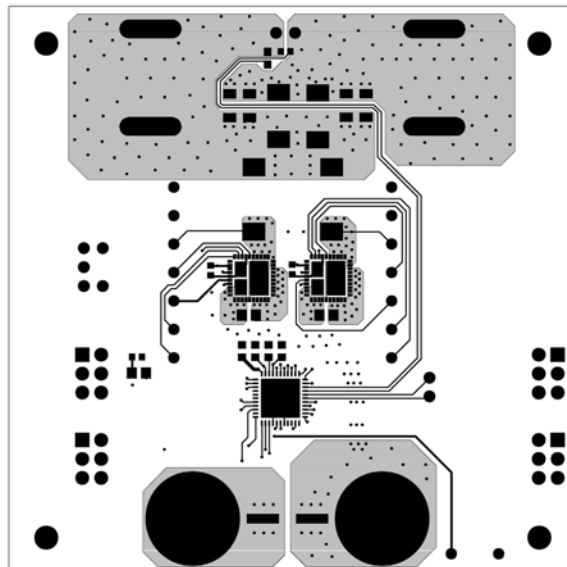

FIGURE 17. PCB - TOP LAYER

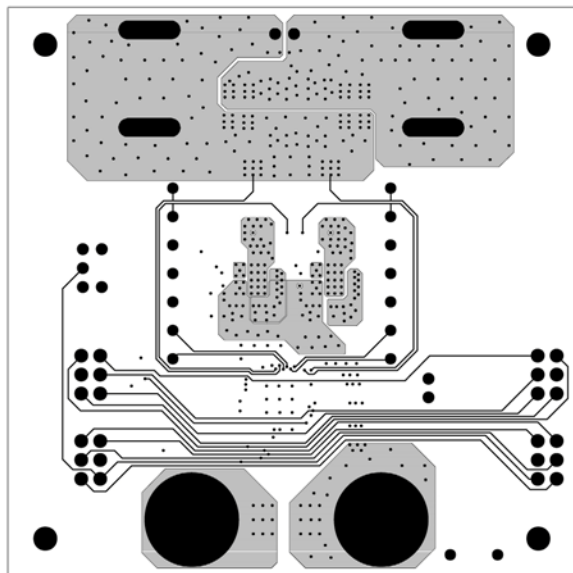

FIGURE 18. PCB - INNER LAYER 1 (TOP VIEW)

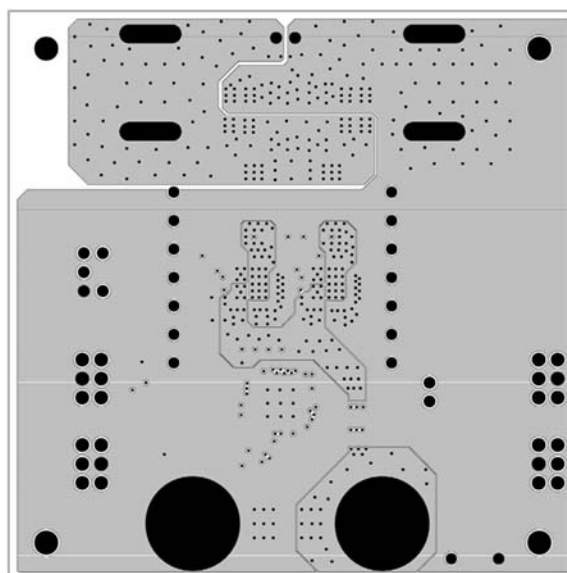

FIGURE 19. PCB - INNER LAYER 2 (TOP VIEW)



## Notice

1. Descriptions of circuits, software and other related information in this document are provided only to illustrate the operation of semiconductor products and application examples. You are fully responsible for the incorporation or any other use of the circuits, software, and information in the design of your product or system. Renesas Electronics disclaims any and all liability for any losses and damages incurred by you or third parties arising from the use of these circuits, software, or information.
2. Renesas Electronics hereby expressly disclaims any warranties against and liability for infringement or any other claims involving patents, copyrights, or other intellectual property rights of third parties, by or arising from the use of Renesas Electronics products or technical information described in this document, including but not limited to, the product data, drawings, charts, programs, algorithms, and application examples.
3. No license, express, implied or otherwise, is granted hereby under any patents, copyrights or other intellectual property rights of Renesas Electronics or others.
4. You shall not alter, modify, copy, or reverse engineer any Renesas Electronics product, whether in whole or in part. Renesas Electronics disclaims any and all liability for any losses or damages incurred by you or third parties arising from such alteration, modification, copying or reverse engineering.
5. Renesas Electronics products are classified according to the following two quality grades: "Standard" and "High Quality". The intended applications for each Renesas Electronics product depends on the product's quality grade, as indicated below.  
"Standard": Computers; office equipment; communications equipment; test and measurement equipment; audio and visual equipment; home electronic appliances; machine tools; personal electronic equipment; industrial robots; etc.  
"High Quality": Transportation equipment (automobiles, trains, ships, etc.); traffic control (traffic lights); large-scale communication equipment; key financial terminal systems; safety control equipment; etc.  
Unless expressly designated as a high reliability product or a product for harsh environments in a Renesas Electronics data sheet or other Renesas Electronics document, Renesas Electronics products are not intended or authorized for use in products or systems that may pose a direct threat to human life or bodily injury (artificial life support devices or systems; surgical implantations; etc.), or may cause serious property damage (space system; undersea repeaters; nuclear power control systems; aircraft control systems; key plant systems; military equipment; etc.). Renesas Electronics disclaims any and all liability for any damages or losses incurred by you or any third parties arising from the use of any Renesas Electronics product that is inconsistent with any Renesas Electronics data sheet, user's manual or other Renesas Electronics document.
6. When using Renesas Electronics products, refer to the latest product information (data sheets, user's manuals, application notes, "General Notes for Handling and Using Semiconductor Devices" in the reliability handbook, etc.), and ensure that usage conditions are within the ranges specified by Renesas Electronics with respect to maximum ratings, operating power supply voltage range, heat dissipation characteristics, installation, etc. Renesas Electronics disclaims any and all liability for any malfunctions, failure or accident arising out of the use of Renesas Electronics products outside of such specified ranges.
7. Although Renesas Electronics endeavors to improve the quality and reliability of Renesas Electronics products, semiconductor products have specific characteristics, such as the occurrence of failure at a certain rate and malfunctions under certain use conditions. Unless designated as a high reliability product or a product for harsh environments in a Renesas Electronics data sheet or other Renesas Electronics document, Renesas Electronics products are not subject to radiation resistance design. You are responsible for implementing safety measures to guard against the possibility of bodily injury, injury or damage caused by fire, and/or danger to the public in the event of a failure or malfunction of Renesas Electronics products, such as safety design for hardware and software, including but not limited to redundancy, fire control and malfunction prevention, appropriate treatment for aging degradation or any other appropriate measures. Because the evaluation of microcomputer software alone is very difficult and impractical, you are responsible for evaluating the safety of the final products or systems manufactured by you.
8. Please contact a Renesas Electronics sales office for details as to environmental matters such as the environmental compatibility of each Renesas Electronics product. You are responsible for carefully and sufficiently investigating applicable laws and regulations that regulate the inclusion or use of controlled substances, including without limitation, the EU RoHS Directive, and using Renesas Electronics products in compliance with all these applicable laws and regulations. Renesas Electronics disclaims any and all liability for damages or losses occurring as a result of your noncompliance with applicable laws and regulations.
9. Renesas Electronics products and technologies shall not be used for or incorporated into any products or systems whose manufacture, use, or sale is prohibited under any applicable domestic or foreign laws or regulations. You shall comply with any applicable export control laws and regulations promulgated and administered by the governments of any countries asserting jurisdiction over the parties or transactions.
10. It is the responsibility of the buyer or distributor of Renesas Electronics products, or any other party who distributes, disposes of, or otherwise sells or transfers the product to a third party, to notify such third party in advance of the contents and conditions set forth in this document.
11. This document shall not be reprinted, reproduced or duplicated in any form, in whole or in part, without prior written consent of Renesas Electronics.
12. Please contact a Renesas Electronics sales office if you have any questions regarding the information contained in this document or Renesas Electronics products.  
(Note 1) "Renesas Electronics" as used in this document means Renesas Electronics Corporation and also includes its directly or indirectly controlled subsidiaries.  
(Note 2) "Renesas Electronics product(s)" means any product developed or manufactured by or for Renesas Electronics.

(Rev.4.0-1 November 2017)



### SALES OFFICES

Renesas Electronics Corporation

<http://www.renesas.com>

Refer to "<http://www.renesas.com/>" for the latest and detailed information.

**Renesas Electronics America Inc.**  
1001 Murphy Ranch Road, Milpitas, CA 95035, U.S.A.  
Tel: +1-408-432-8888, Fax: +1-408-434-5351

**Renesas Electronics Canada Limited**  
9251 Yonge Street, Suite 8309 Richmond Hill, Ontario Canada L4C 9T3  
Tel: +1-905-237-2004

**Renesas Electronics Europe Limited**  
Dukes Meadow, Millboard Road, Bourne End, Buckinghamshire, SL8 5FH, U.K.  
Tel: +44-1628-651-700, Fax: +44-1628-651-804

**Renesas Electronics Europe GmbH**  
Arcadiastrasse 10, 40472 Düsseldorf, Germany  
Tel: +49-211-6503-0, Fax: +49-211-6503-1327

**Renesas Electronics (China) Co., Ltd.**  
Room 1709 Quantum Plaza, No.27 ZhichunLu, Haidian District, Beijing, 100191 P. R. China  
Tel: +86-10-8235-1155, Fax: +86-10-8235-7679

**Renesas Electronics (Shanghai) Co., Ltd.**  
Unit 301, Tower A, Central Towers, 555 Langao Road, Putuo District, Shanghai, 200333 P. R. China  
Tel: +86-21-2226-0888, Fax: +86-21-2226-0999

**Renesas Electronics Hong Kong Limited**  
Unit 1601-1611, 16/F., Tower 2, Grand Century Place, 193 Prince Edward Road West, Mongkok, Kowloon, Hong Kong  
Tel: +852-2265-6688, Fax: +852-2886-9022

**Renesas Electronics Taiwan Co., Ltd.**  
13F, No. 363, Fu Shing North Road, Taipei 10543, Taiwan  
Tel: +886-2-8175-9600, Fax: +886-2-8175-9670

**Renesas Electronics Singapore Pte. Ltd.**  
80 Bendemeer Road, Unit #06-02 Hyflux Innovation Centre, Singapore 339949  
Tel: +65-6213-0200, Fax: +65-6213-0300

**Renesas Electronics Malaysia Sdn.Bhd.**  
Unit 1207, Block B, Menara Amcorp, Amcorp Trade Centre, No. 18, Jln Persiaran Barat, 46050 Petaling Jaya, Selangor Darul Ehsan, Malaysia  
Tel: +60-3-7955-9390, Fax: +60-3-7955-9510

**Renesas Electronics India Pvt. Ltd.**  
No.777C, 100 Feet Road, HAL 2nd Stage, Indiranagar, Bangalore 560 038, India  
Tel: +91-80-67208700, Fax: +91-80-67208777

**Renesas Electronics Korea Co., Ltd.**  
17F, KAMCO Yangjae Tower, 262, Gangnam-daero, Gangnam-gu, Seoul, 06265 Korea  
Tel: +82-2-558-3737, Fax: +82-2-558-5338