

ISL8105AEVAL1Z

Evaluation Board

AN1258
Rev 0.00
Nov 1, 2007

Description

The ISL8105AEVAL1Z evaluation board highlights the operations of the ISL8105A controller in a DC/DC application. The evaluation board is configured for an output voltage of 1.8V and 15A maximum load.



FIGURE 1. ISL8105AEVAL1Z EVALUATION BOARD

Power and Load Connections

INPUT VOLTAGE

The evaluation board is optimized for an input supply of 12V, however, the input supply based on the connection can range from 4.5V to 5.5V or 6.5V to 14.4V.

The IC bias supply and the converter input voltage are connected together through R₁₀ to provide single rail power supply application.

OUTPUT VOLTAGE LOADING AND MONITORING

Connect the positive lead of the electronic load and the positive lead of a digital multimeter to the V_{OUT} terminal (J4) and the ground lead to the GND terminal (J5). The scope probe terminal (TPV01) can be used to monitor V_{OUT} with an oscilloscope.

Start-up

The ISL8105A starts up when V_{BIAS} rises above POR threshold and the COMP/EN rises above V_{DISABLE} level. The entire start-up time sequence from POR typically takes up to 17ms. There is fixed 6.8ms delay for the POR to initiate the Overcurrent Protection (OCP) sample and hold operation. The OCP sample and hold operation takes an additional 0ms to 3.4ms (the longer time occurs with the higher overcurrent setting). When the OCP sampling and hold operations are done, the soft-start function internally ramps the reference on the non-inverting terminal of the error amp from 0V to 0.6V in 6.8ms (typ).

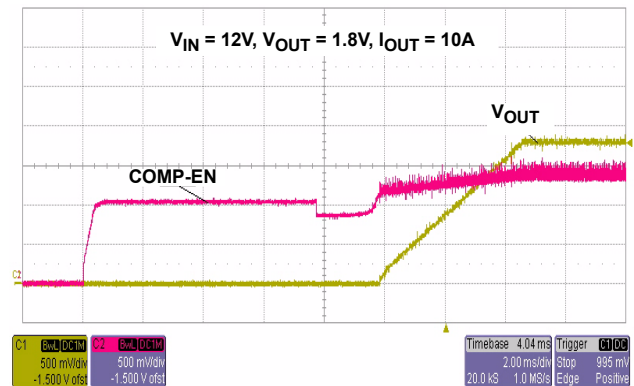

FIGURE 2. SOFT-START

Figure 1 shows the start-up profile of the ISL8105AEVAL1Z in relation to the start-up of the 12V input supply and the bias supply.

Soft-Start with Pre-Biased Output

If the output is pre-biased to a voltage less than the expected value, the ISL8105A will detect that condition. Neither MOSFET will turn on until the soft-start ramp voltage exceeds the output; V_{OUT} starts seamlessly ramping from there.

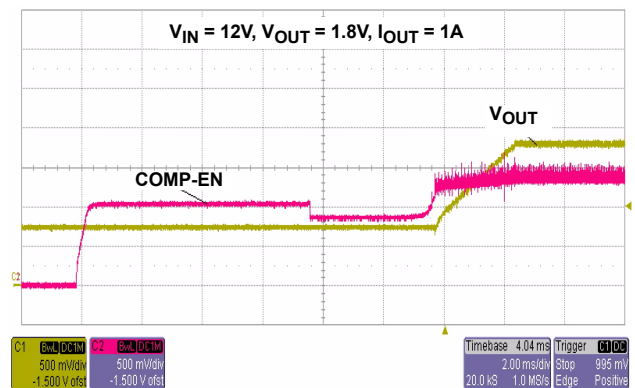

FIGURE 3. SOFT-START WITH PRE-BIASED OUTPUT

Output Performance

Switching Frequency

The evaluation board comes with a ISL8105A that has a fixed switching frequency of 600kHz.

Output Ripple

Figure 4 shows the ripple voltage on the output of the regulator.

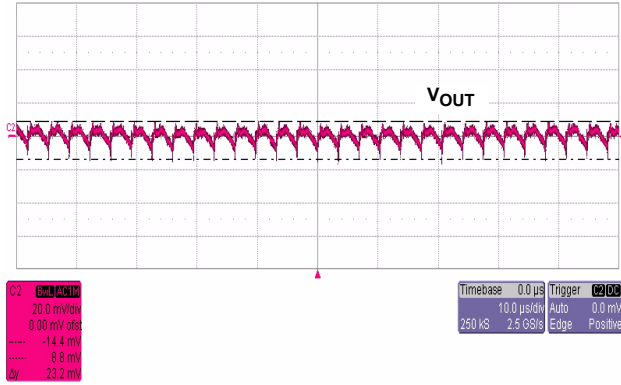

FIGURE 4. OUTPUT VOLTAGE RIPPLE (20MHz BW)

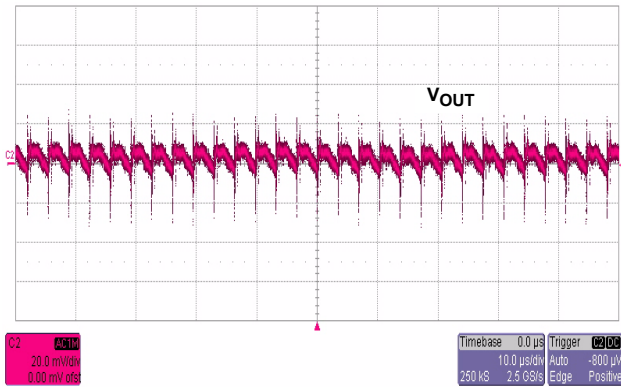

FIGURE 5. OUTPUT VOLTAGE RIPPLE AND NOISE (500MHz BW)

Transient Performance

Figures 6, 7 and 8 show the response of the output when subjected to transient loading from 7.5A to 15A.

Overcurrent Protection

The overcurrent function limits the output current by using the bottom-side MOSFET's $r_{DS(ON)}$ to monitor the current. A resistor, R_{BSOC} , (R_g) programs the overcurrent trip level. This method enhances the converter's efficiency and reduces cost by eliminating a current sensing resistor. If overcurrent is detected, the output immediately shuts off, it cycles the soft-start function in a hiccup mode (2 dummy soft-start time-outs, then up to one real one) to provide fault protection. If the shorted condition is not removed, this cycle will continue indefinitely. Figure 9 shows the overcurrent response and hiccup mode operation.

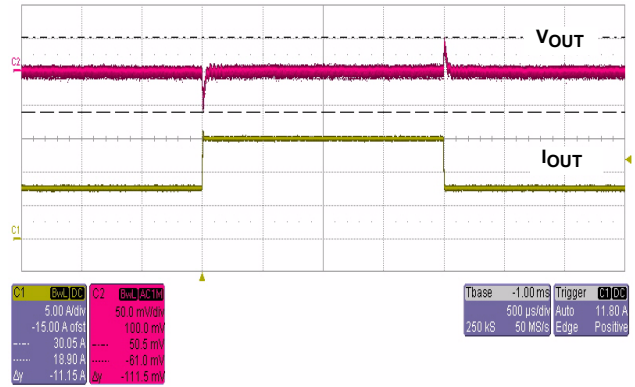

FIGURE 6. TRANSIENT RESPONSE

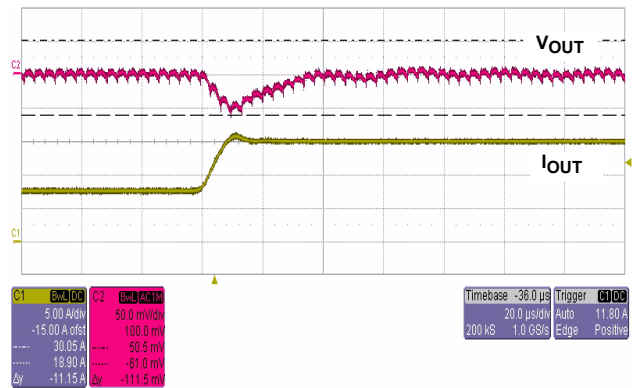

FIGURE 7. TRANSIENT RESPONSE

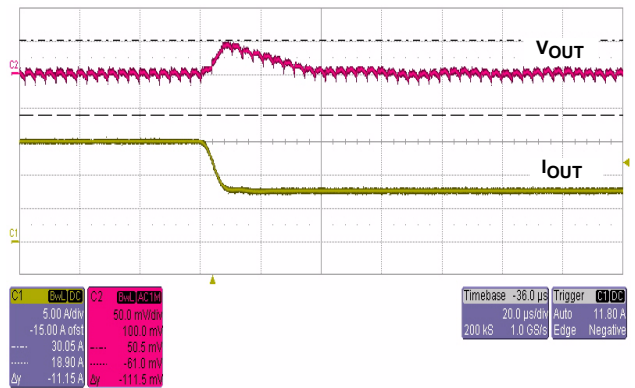

FIGURE 8. TRANSIENT RESPONSE

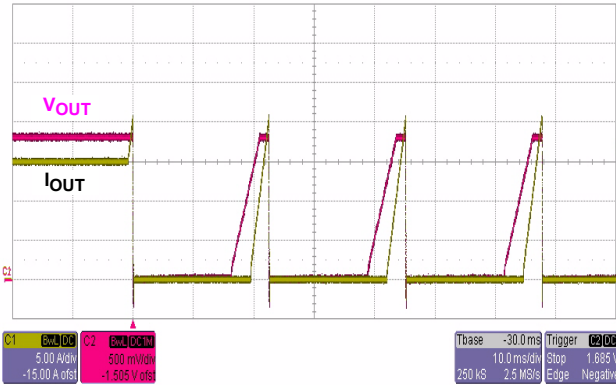

FIGURE 9. OVERCURRENT HICCUP MODE

The overcurrent function will trip at a peak inductor current (I_{PEAK}) determined by Equation 1:

$$I_{PEAK} = \frac{2 \cdot I_{OCSET} \cdot R_{OCSET}}{r_{DS(ON)}} \quad (EQ. 1)$$

where I_{OCSET} is the internal $21.5\mu A$ OCSET current source.

The OC trip point varies mainly due to the MOSFET's $r_{DS(ON)}$ variations. To avoid overcurrent tripping in the normal operating load range, calculate the R_{OCSET} resistor from Equation 1 using:

1. The maximum $r_{DS(ON)}$ at the highest junction temperature.
2. The minimum I_{OCSET} from the specification table.

Determine I_{PEAK} for $I_{PEAK} > I_{OUT(MAX)} + (\Delta I)/2$

where ΔI is the output inductor ripple current.

The overcurrent trip point on the evaluation board has been set to 19A for 5V_{BIAS} (24A for 12V_{BIAS}).

Figure 10 shows the output voltage recovers from overcurrent condition.

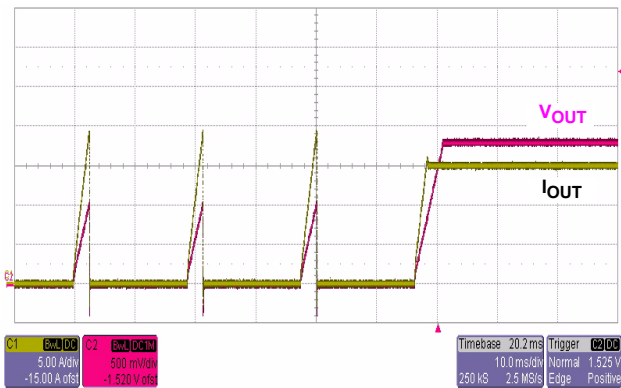

FIGURE 10. OVERCURRENT HICCUP MODE

Efficiency

ISL8105A based regulators enable the design of highly efficient systems. The efficiency of the evaluation board using a 5V and a 12V input supply is shown in Figure 11.

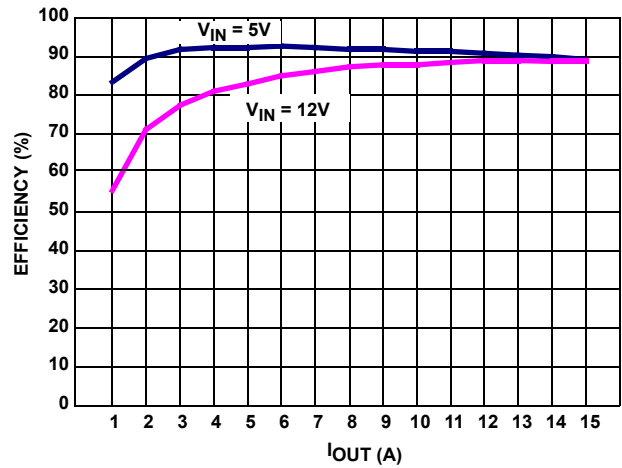

FIGURE 11. EVALUATION BOARD EFFICIENCY ($V_{OUT} = 1.8V$)

References

For Intersil documents available on the web, see <http://www.intersil.com/>

- [1] ISL8105, ISL8105A Data Sheet, Intersil Corporation, FN6306

ISL8105AEVAL1Z Schematic

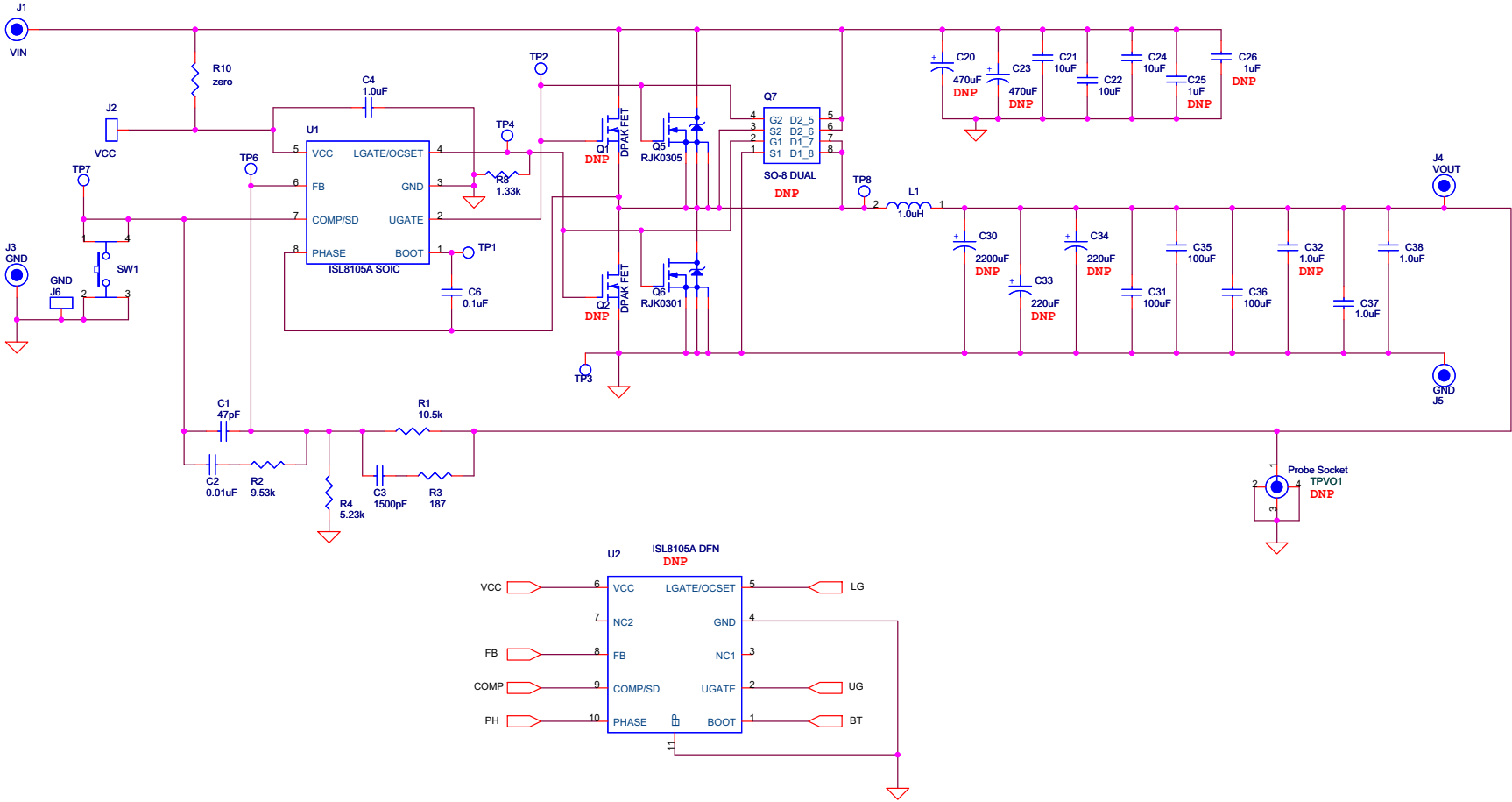

ISL8105AEVAL1Z Bill of Materials

ID	REFERENCE	QTY	PART NUMBER	PART TYPE	DESCRIPTION	PACKAGE	VENDOR
1	U1	1	ISL8105AIBZ	IC, Linear	IC, Single PWM Controller	8LD SOIC	Intersil
2	U2	DNP	ISL8105AIRZ	IC, Linear	IC, Single PWM Controller	10LD DFN	Intersil
3	Q1, Q2	DNP		MOSFET	N-Channel	DPAK	
4	Q5	1	RJK0305	MOSFET	N-Channel, 30V	LFPAK	Renasas
5	Q6	1	RJK0301	MOSFET	N-Channel, 30V	LFPAK	Renasas
6	Q7	DNP		MOSFET	N-Channel, Dual	8LD SOIC	
7	L1	1	IHLP-5050FDER1R0M01	Inductor	1.0μH, high current inductor	SMD	Vishay
8	SW1	1	EVQ-PAD04M	Push Switch	SWITCH-PUSH, TH, 6mm, 1P, PUSHB MOM-SPST		PANASONIC
CAPACITORS							
9	C1	1		Capacitor, Ceramic, X7R	47pF, 50V, 5%, NPO, ROHS	SM_0603	TDK/Generic
10	C2	1		Capacitor, Ceramic, X7R	0.01μF, 50V, 10%, ROHS	SM_0603	TDK/Generic
11	C3	1		Capacitor, Ceramic, X7R	1500pF, 50V, 10%, ROHS	SM_0603	TDK/Generic
12	C4	1		Capacitor, Ceramic, X7R	1μF, 16V, 10%, X7R, ROHS	SM_0603	TDK/Generic
13	C6	1		Capacitor, Ceramic, X7R	0.1μF, 16V, 10%, ROHS	SM_0603	TDK/Generic
14	C20, C23	DNP	16MCZ470M8X11.5	Capacitor, Alum. Elec	470μF, 16V, 20%, 21mΩ, Pb-free	RADIAL 8x11	RUBYCON
15	C21, C22, C24	3		Capacitor, Ceramic, X5R	10μF, 16V, 10%, ROHS	SM_1210	TDK/Generic
16	C25, C26	DNP		Capacitor, Ceramic, X5R	1μF, 6.3V, 20%, ROHS	SM_1812	TDK/Generic
17	C30, C33, C34	DNP	6.3MCZ1200M8X16	Capacitor, Alum. Elec	1200μF, 6.3V, 20%, 18mΩ, Pb-free	RADIAL 8x16	RUBYCON
18	C31, C35, C36	3		Capacitor, Ceramic, X5R	100μF, 6.3V, 20%, ROHS	SM_1812	TDK/Generic
19	C32	DNP		Capacitor, Ceramic, X5R	1μF, 6.3V, 10%, ROHS	SM_0603	TDK/Generic
20	C37, C38	2		Capacitor, Ceramic, X5R	1μF, 6.3V, 10%, ROHS	SM_0603	TDK/Generic
RESISTORS							
21	R1	1		Resistor, Film	10.5kΩ, 1%, 1/16W	SM_0603	Panasonic/Generic
22	R2	1		Resistor, Film	9.53kΩ, 1%, 1/16W	SM_0603	Panasonic/Generic
23	R3	1		Resistor, Film	187Ω, 1%, 1/16W	SM_0603	Panasonic/Generic
24	R4	1		Resistor, Film	5.23kΩ, 1%, 1/16W	SM_0603	Panasonic/Generic
25	R8	1		Resistor, Film	1.33kΩ, 1%, 1/16W	SM_0603	Panasonic/Generic
26	R10	1	RC0805JR-070RL	Resistor, Film	1/8W, TF, ROHS	SM_0805	YAGEO
OTHERS							
27	TPVO1	DNP	0293-0-15-15-16-27-10-0	Terminal, Scope Probe	CONN-PIN RECEPTACLE, 0.086 DIA, 0.200 L, ROHS		MILL-MAX
28	J1, J3, J4, J5	4	111-0702-001	Banana Connector	CONN-GEN, BIND. POST, THMBNUT-GND		JOHNSON COMPONENTS
29	J2, J6	2	1514-2	Turret Post	CONN-TURRET, TERMINAL POST, TH, ROHS		Keystone
30	TP1-TP4, TP6-TP8	DNP	5002	Test Point	CONN-MINI TEST POINT, VERTICAL, WHITE, ROHS		Keystone

ISL8105AEVAL1Z Printed Circuit Board Layers

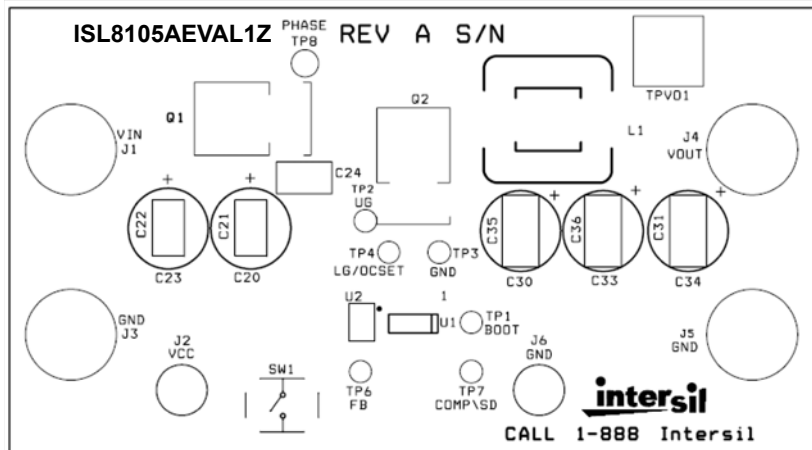

FIGURE 12. ISL8105AEVAL1Z - TOP LAYER (SILKSCREEN)

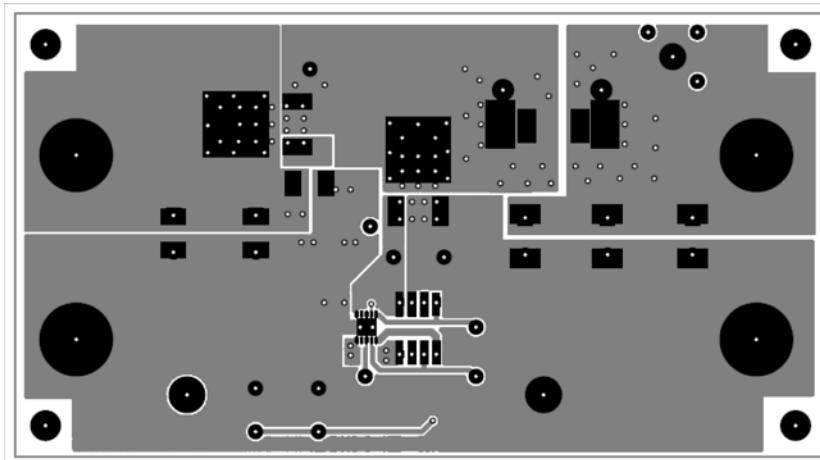

FIGURE 13. ISL8105AEVAL1Z - TOP LAYER (COMPONENT SIDE)

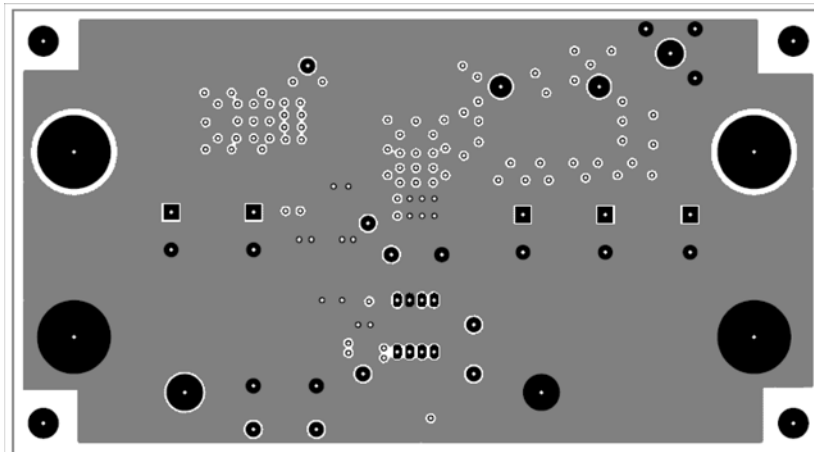

FIGURE 14. ISL8105AEVAL1Z - LAYER 2

ISL8105AEVAL1Z Printed Circuit Board Layers (Continued)

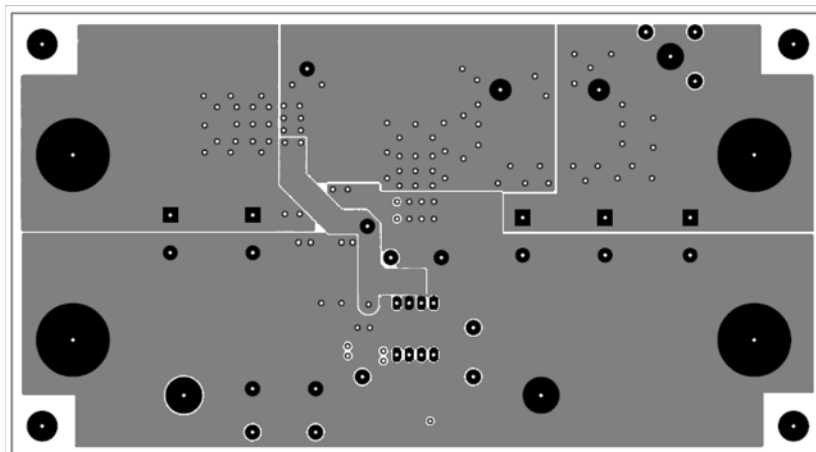

FIGURE 15. ISL8105AEVAL1Z - LAYER 3

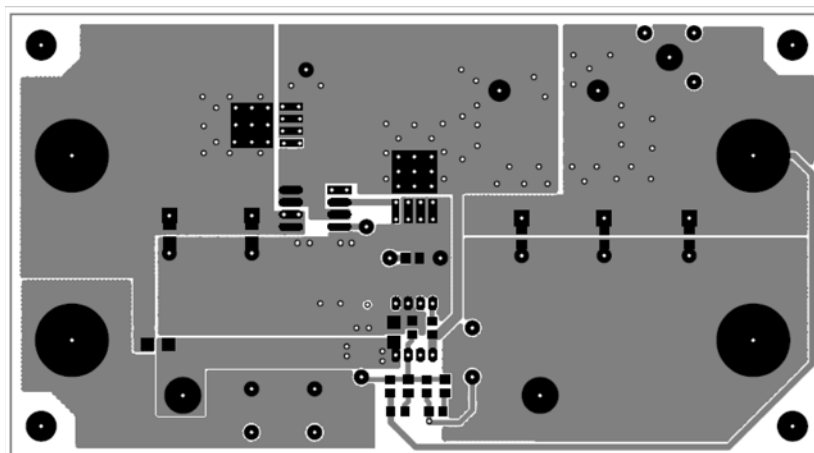

FIGURE 16. ISL8105AEVAL1Z - LAYER 4

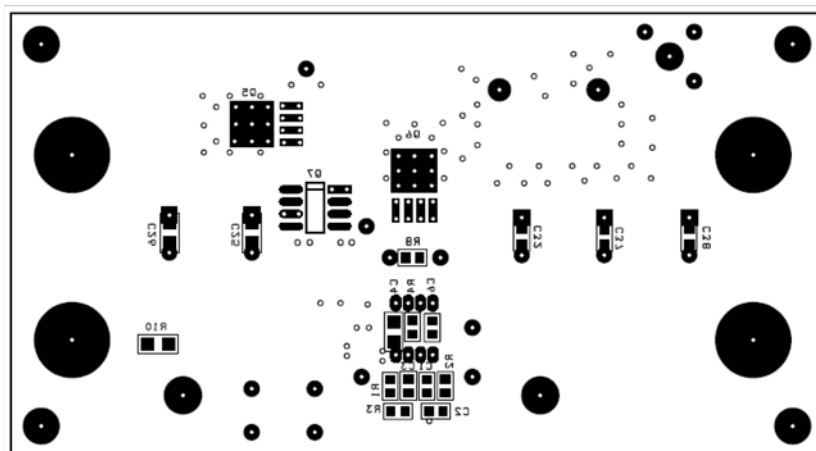

FIGURE 17. ISL8105AEVAL1Z - BOTTOM LAYER (SOLDER SIDE)

Notice

1. Descriptions of circuits, software and other related information in this document are provided only to illustrate the operation of semiconductor products and application examples. You are fully responsible for the incorporation or any other use of the circuits, software, and information in the design of your product or system. Renesas Electronics disclaims any and all liability for any losses and damages incurred by you or third parties arising from the use of these circuits, software, or information.
2. Renesas Electronics hereby expressly disclaims any warranties against and liability for infringement or any other claims involving patents, copyrights, or other intellectual property rights of third parties, by or arising from the use of Renesas Electronics products or technical information described in this document, including but not limited to, the product data, drawings, charts, programs, algorithms, and application examples.
3. No license, express, implied or otherwise, is granted hereby under any patents, copyrights or other intellectual property rights of Renesas Electronics or others.
4. You shall not alter, modify, copy, or reverse engineer any Renesas Electronics product, whether in whole or in part. Renesas Electronics disclaims any and all liability for any losses or damages incurred by you or third parties arising from such alteration, modification, copying or reverse engineering.
5. Renesas Electronics products are classified according to the following two quality grades: "Standard" and "High Quality". The intended applications for each Renesas Electronics product depends on the product's quality grade, as indicated below.
"Standard": Computers; office equipment; communications equipment; test and measurement equipment; audio and visual equipment; home electronic appliances; machine tools; personal electronic equipment; industrial robots; etc.
"High Quality": Transportation equipment (automobiles, trains, ships, etc.); traffic control (traffic lights); large-scale communication equipment; key financial terminal systems; safety control equipment; etc.
Unless expressly designated as a high reliability product or a product for harsh environments in a Renesas Electronics data sheet or other Renesas Electronics document, Renesas Electronics products are not intended or authorized for use in products or systems that may pose a direct threat to human life or bodily injury (artificial life support devices or systems; surgical implantations; etc.), or may cause serious property damage (space system; undersea repeaters; nuclear power control systems; aircraft control systems; key plant systems; military equipment; etc.). Renesas Electronics disclaims any and all liability for any damages or losses incurred by you or any third parties arising from the use of any Renesas Electronics product that is inconsistent with any Renesas Electronics data sheet, user's manual or other Renesas Electronics document.
6. When using Renesas Electronics products, refer to the latest product information (data sheets, user's manuals, application notes, "General Notes for Handling and Using Semiconductor Devices" in the reliability handbook, etc.), and ensure that usage conditions are within the ranges specified by Renesas Electronics with respect to maximum ratings, operating power supply voltage range, heat dissipation characteristics, installation, etc. Renesas Electronics disclaims any and all liability for any malfunctions, failure or accident arising out of the use of Renesas Electronics products outside of such specified ranges.
7. Although Renesas Electronics endeavors to improve the quality and reliability of Renesas Electronics products, semiconductor products have specific characteristics, such as the occurrence of failure at a certain rate and malfunctions under certain use conditions. Unless designated as a high reliability product or a product for harsh environments in a Renesas Electronics data sheet or other Renesas Electronics document, Renesas Electronics products are not subject to radiation resistance design. You are responsible for implementing safety measures to guard against the possibility of bodily injury, injury or damage caused by fire, and/or danger to the public in the event of a failure or malfunction of Renesas Electronics products, such as safety design for hardware and software, including but not limited to redundancy, fire control and malfunction prevention, appropriate treatment for aging degradation or any other appropriate measures. Because the evaluation of microcomputer software alone is very difficult and impractical, you are responsible for evaluating the safety of the final products or systems manufactured by you.
8. Please contact a Renesas Electronics sales office for details as to environmental matters such as the environmental compatibility of each Renesas Electronics product. You are responsible for carefully and sufficiently investigating applicable laws and regulations that regulate the inclusion or use of controlled substances, including without limitation, the EU RoHS Directive, and using Renesas Electronics products in compliance with all these applicable laws and regulations. Renesas Electronics disclaims any and all liability for damages or losses occurring as a result of your noncompliance with applicable laws and regulations.
9. Renesas Electronics products and technologies shall not be used for or incorporated into any products or systems whose manufacture, use, or sale is prohibited under any applicable domestic or foreign laws or regulations. You shall comply with any applicable export control laws and regulations promulgated and administered by the governments of any countries asserting jurisdiction over the parties or transactions.
10. It is the responsibility of the buyer or distributor of Renesas Electronics products, or any other party who distributes, disposes of, or otherwise sells or transfers the product to a third party, to notify such third party in advance of the contents and conditions set forth in this document.
11. This document shall not be reprinted, reproduced or duplicated in any form, in whole or in part, without prior written consent of Renesas Electronics.
12. Please contact a Renesas Electronics sales office if you have any questions regarding the information contained in this document or Renesas Electronics products.
(Note 1) "Renesas Electronics" as used in this document means Renesas Electronics Corporation and also includes its directly or indirectly controlled subsidiaries.
(Note 2) "Renesas Electronics product(s)" means any product developed or manufactured by or for Renesas Electronics.

(Rev.4.0-1 November 2017)



SALES OFFICES

Renesas Electronics Corporation

<http://www.renesas.com>

Refer to "<http://www.renesas.com/>" for the latest and detailed information.

Renesas Electronics America Inc.
1001 Murphy Ranch Road, Milpitas, CA 95035, U.S.A.
Tel: +1-408-432-8888, Fax: +1-408-434-5351

Renesas Electronics Canada Limited
9251 Yonge Street, Suite 8309 Richmond Hill, Ontario Canada L4C 9T3
Tel: +1-905-237-2004

Renesas Electronics Europe Limited
Dukes Meadow, Millboard Road, Bourne End, Buckinghamshire, SL8 5FH, U.K.
Tel: +44-1628-651-700, Fax: +44-1628-651-804

Renesas Electronics Europe GmbH
Arcadiastrasse 10, 40472 Düsseldorf, Germany
Tel: +49-211-6503-0, Fax: +49-211-6503-1327

Renesas Electronics (China) Co., Ltd.
Room 1709 Quantum Plaza, No.27 ZhichunLu, Haidian District, Beijing, 100191 P. R. China
Tel: +86-10-8235-1155, Fax: +86-10-8235-7679

Renesas Electronics (Shanghai) Co., Ltd.
Unit 301, Tower A, Central Towers, 555 Langao Road, Putuo District, Shanghai, 200333 P. R. China
Tel: +86-21-2226-0888, Fax: +86-21-2226-0999

Renesas Electronics Hong Kong Limited
Unit 1601-1611, 16/F., Tower 2, Grand Century Place, 193 Prince Edward Road West, Mongkok, Kowloon, Hong Kong
Tel: +852-2265-6688, Fax: +852-2886-9022

Renesas Electronics Taiwan Co., Ltd.
13F, No. 363, Fu Shing North Road, Taipei 10543, Taiwan
Tel: +886-2-8175-9600, Fax: +886-2-8175-9670

Renesas Electronics Singapore Pte. Ltd.
80 Bendemeer Road, Unit #06-02 Hyflux Innovation Centre, Singapore 339949
Tel: +65-6213-0200, Fax: +65-6213-0300

Renesas Electronics Malaysia Sdn.Bhd.
Unit 1207, Block B, Menara Amcorp, Amcorp Trade Centre, No. 18, Jln Persiaran Barat, 46050 Petaling Jaya, Selangor Darul Ehsan, Malaysia
Tel: +60-3-7955-9390, Fax: +60-3-7955-9510

Renesas Electronics India Pvt. Ltd.
No.777C, 100 Feet Road, HAL 2nd Stage, Indiranagar, Bangalore 560 038, India
Tel: +91-80-67208700, Fax: +91-80-67208777

Renesas Electronics Korea Co., Ltd.
17F, KAMCO Yangjae Tower, 262, Gangnam-daero, Gangnam-gu, Seoul, 06265 Korea
Tel: +82-2-558-3737, Fax: +82-2-558-5338