

ISL7823xEVAL1Z

Evaluation Board User Guide

UG015
Rev 2.00
October 26, 2016

Description

The ISL78233EVAL1Z, ISL78234EVAL1Z, and ISL78235EVAL1Z evaluation boards are used to demonstrate the performance of the [ISL78233](#), [ISL78234](#), and [ISL78235](#) low quiescent current, high efficiency synchronous buck regulators. The evaluation boards are intended for use by customers with requirements for point-of-load automotive applications with 2.7V to 5.5V input supply voltage, output voltages down to 0.8V and up to 5A output current.

The ISL78233, ISL78234, and ISL78235 are offered in a 3x3mm 16 Ld TQFN package with 1mm maximum height. The complete area that the regulator occupies can be as small as 0.22in².

Specifications

PART NUMBER	I _{OUT} (MAX) (A)	f _{SW} RANGE (MHz)	V _{IN} RANGE (V)	V _{OUT} RANGE (V)	PART SIZE (mm)
ISL78235	5	Programmable 1 to 4	2.7 to 5.5	0.8 to 5.5	3x3
ISL78234	4				
ISL78233	3				

PCB SPECIFICATION

Board dimension: 2.025 x 2.725 in
of Layers: 4
FR-4 Thickness: 1.57mm
Copper Weight: 2oz.

NOTES:

1. The evaluation board default V_{OUT} = 1.8V.
2. The evaluation board default f_{SW} = 2MHz.

Key Features

- 2.7V to 5.5V input voltage range
- Synchronous buck regulator up to 95% efficiency
- 1% reference accuracy over temperature
- Resistor adjustable frequency from 500kHz to 4MHz; Default set to 2MHz
- External synchronization from 1MHz to 4MHz
- 100ns maximum phase minimum on time allows wide output regulation operating at 2MHz
- Internal soft-start set to 1ms; adjustable with external soft-start capacitor
- Over-temperature, overcurrent, overvoltage, and negative overcurrent protection

Related Literature

- For a full list of related documents please visit our website - [ISL78233](#), [ISL78234](#), [ISL78235](#) product pages

Ordering Information

PART NUMBER	DESCRIPTION
ISL78235EVAL1Z	Evaluation Board for 5A Sync Buck ISL78235
ISL78234EVAL1Z	Evaluation Board for 4A Sync Buck ISL78234
ISL78233EVAL1Z	Evaluation Board for 3A Sync Buck ISL78233



FIGURE 1. ISL78235EVAL1Z EVALUATION BOARD PHOTO

Recommended Equipment

The following equipment is recommended to perform testing:

- 0V to 5V power supply with 10A source current capability
- Electronic load capable of sinking current up to 10A
- Digital Multimeters (DMMs)
- 500MHz quad-trace oscilloscope
- Signal generator for EN and/or SYNC pins

Quick Setup Guide

1. Ensure that the circuit is correctly connected to the supply and loads prior to applying any power.
2. Connect the bias supply to V_{IN} , the plus terminal to V_{IN} (P4) and the negative return to PGND (P5).
3. Connect the output load to V_{OUT} , the plus terminal to VOUT (P3) and the negative return to PGND (P7).
4. Verify that SW2 is in the proper position for PFM or PWM.
5. Verify that the position is ON for SW1.
6. Turn on the power supply and set for 2.7V to 5.0V.
7. Verify the output voltage is 1.8V for V_{OUT} .

Evaluating Other Output Voltages

The ISL78233EVAL1Z, ISL78234EVAL1Z, and ISL78235EVAL1Z evaluation board outputs are preset to 1.8V for V_{OUT} . The output voltage can be adjusted from 0.8V to 3.3V. The output voltage programming resistor, R_1 , depends on the desired output voltage of the regulator. It is recommended to have R_2 set to 100k Ω . The value for R_1 is typically between 66k Ω and 450k Ω , as shown in [Equation 1](#).

$$R_1 = R_2 \cdot (V_O / V_{FB} - 1) \quad (\text{EQ. 1})$$

For faster transient response performance, add 10pF to 22pF in parallel to R_1 . Check loop compensation analysis to ensure optimum performance before use of capacitance.

Frequency Control

The ISL78233, ISL78234, and ISL78235 have an FS pin that controls the frequency of operation. Programmable frequency allows for optimization between efficiency and external component size. Default switching frequency is 2MHz when FS is tied to V_{IN} ($R_{11} = 0$ and R_{12} is open). By removing R_{11} and changing the value of R_{12} , the switching frequency can be changed from 500kHz to 4MHz according to [Equation 2](#):

$$R_T [\text{k}\Omega] = \frac{220 \cdot 10^3}{f_{\text{OSC}} [\text{kHz}]} - 14 \quad (\text{EQ. 2})$$

Please refer to the [ISL78235](#), [ISL78233](#), [ISL78234](#) datasheets for more details.

Soft-Start Control

The ISL78233, ISL78234, and ISL78235 have an SS pin that controls the soft-start up time. Short SS pin to SGND for internal soft-start (approximately 1ms). Populate a capacitor, C_{SS} , to adjust the soft-start time. This capacitor, along with an internal

2.1 μ A current source sets the soft-start interval of the converter, t_{SS} .

$$C_{SS} [\mu\text{F}] = 3.5 \cdot t_{SS} [\text{s}] \quad (\text{EQ. 3})$$

C_{SS} should be no more than 33nF to insure proper soft-start reset after fault condition. The ISL78233EVAL1Z, ISL78234EVAL1Z, and ISL78235EVAL1Z have a default 33nF on the board for a ~10ms soft-start time.

Control Switches for EN and SYNC

The evaluation board contains switches SW1 and SW2 for control of the EN and SYNC pin. [Table 1](#) details this function.

TABLE 1. SWITCH SETTINGS

SW1	ENABLE	FUNCTION
1 (LEFT)	OFF	DISABLE IC
3 (RIGHT)	ON	ENABLE IC
SW2	SYNC	FUNCTION
1 (LEFT)	PFM	Skip mode at light load
3 (RIGHT)	PWM	Fixed PWM frequency at light load

Power Inductor

The evaluation board contains a 0.68 μ H output power inductor. It has a 13.5A saturation current that is able to handle the peak current limit of the IC. The inductor is chosen to optimize performance for $V_{IN} = 5\text{V}$, $V_{OUT} = 1.8\text{V}$ at 2MHz switching frequency for up to 5A output currents.

Internal vs External Compensation

The ISL78233, ISL78234 and ISL78235 feature an internal compensation network on the output of the error amplifier. The internal compensation simplifies design by reducing external components while stabilizing the regulator under transient load response. To use internal compensation network, tie the COMP pin to VDD.

The restriction of an internal compensation network is that it does not provide flexibility to optimize the compensation network for conditions when additional output capacitance is needed to minimize output overshoot from fast transient loading. The added capacitance affects the stability and response of the feedback loop. The internal compensation network is well suited for a wide range of switching frequencies and load di/dt transients, however, if the feedback network needs to be better optimized for the application, external compensation should be used. When the COMP pin is not connected to VDD, an RC network from COMP pin to GND is used to provide the external compensation.

For more information on the specification of the internal compensation network and designing for stability, refer to [ISL78235](#), [ISL78233](#), [ISL78234](#) datasheets for more details.

PCB Layout Recommendation

The PCB layout is a very important converter design step to make sure the designed converter works well. For ISL78233, ISL78234, and ISL78235, the power loop is composed of the output inductor (Lo), the output capacitor (C_{OUT}), the PHASE pins and the PGND pins. It is necessary to make the power loop as small as possible and the connecting traces among them should be direct, short and wide. The switching node of the converter (PHASE pins) and the traces connected to the node are noisy. Keep the voltage feedback trace away from these noisy traces. The input capacitor should be placed as close as possible to the VIN/VDD and GND pin. The ground of input and output capacitors should be connected as close as possible. The heat of the IC is mainly dissipated through the thermal pad. Maximizing the copper area connected to the thermal pad is preferable. In addition, a solid ground plane is helpful for better EMI performance. It is recommended to add at least five vias ground connection within the pad for the best thermal relief.

ISL78233EVAL1Z, ISL78234EVAL1Z, ISL78235EVAL1Z Schematics

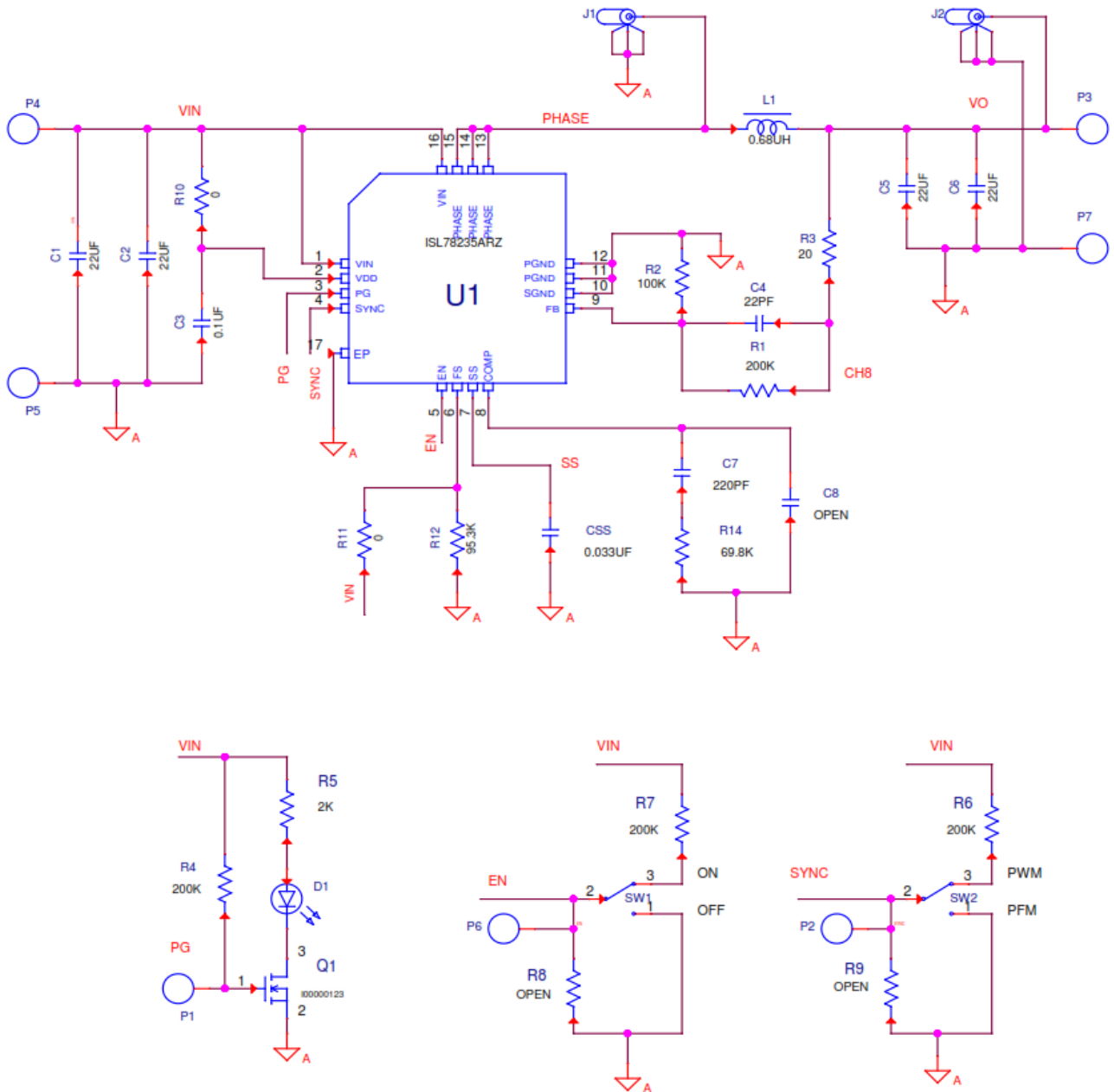

NOTES:

- ISL78235EVAL1Z schematic is shown.
- ISL78233EVAL1Z and ISL78234EVAL1Z schematics are equivalent.

FIGURE 2. SCHEMATICS

Bill of Materials

PART NUMBER	QTY	UNITS	REFERENCE DESIGNATOR	DESCRIPTION	MANUFACTURER	MANUFACTURER PART
ISL78233EVAL1Z	1	ea.		PWB-PCB, ISL78235, REVA, RoHS	IMAGINEERING INC	ISL78233EVAL1Z
ISL78234EVAL1Z	1	ea.		PWB-PCB, ISL78234, REVA, RoHS	IMAGINEERING INC	ISL78234EVAL1Z
ISL78235EVAL1Z	1	ea.		PWB-PCB, ISL78235, REVA, RoHS	IMAGINEERING INC	ISL78235EVAL1Z
ISL78233ARZ or ISL78234ARZ or ISL78235ARZ	1	ea.	U1	IC- 3A, 4A, or 5A BUCK REGULATOR, 16P, QFN, 3x3, RoHS	INTERSIL	ISL78233ARZ or ISL78234ARZ or ISL78235ARZ
H1045-00220-50V5-T	1	ea.	C4	CAP, SMD, 0603, 22pF, 50V, 5%, COG, RoHS	VENKEL	C0603C0G500-220JNE
H1045-00221-50V10-T	1	ea.	C7	CAP, SMD, 0603, 220pF, 50V, 10%, X7R, RoHS	MURATA	GRM188R71H221KA01D
H1045-00333-16V10-T	1	ea.	CSS	CAP, SMD, 0603, 33000pF, 16V, 10%, X7R, RoHS	VENKEL	C0603X7R160-333KNE
H1045-00104-16V10-T	1	ea.	C3	CAP, SMD, 0603, 0.1μF, 16V, 10%, X7R, RoHS	VENKEL	C0603X7R160-104KNE
H1045-DNP	0	ea.	C8	CAP, SMD, 0603, DNP-PLACE HOLDER, RoHS		
H1065-00226-10V10-T	4	ea.	C1, C2, C5, C6	CAP, SMD, 1206, 22μF, 10, 10%, X7R, RoHS	TAIYO YUDEN MURATA	LMK316AB7226KL-TR GRM31CR71A226KE15L
IHLP2020CZERR68M01-T	1	ea.	L1	COIL-PWR INDUCTOR, SMD, 5.49x5.18, 0.68μH, 20%, 10.2A, RoHS	VISHAY	IHLP2020CZERR68M01
131-4353-00	2	ea.	J1, J2	CONN-SCOPE PROBE TEST PT, COMPACT, PCB MNT, RoHS	TEKTRONIX	131-4353-00
1514-2	4	ea.	P4, P5, P7, P8	CONN-TURRET, TERMINAL POST, TH, RoHS	KEYSTONE	1514-2
5002	3	ea.	P1, P2, P6	CONN-MINI TEST POINT, VERTICAL, WHITE, RoHS	KEYSTONE	5002
LTST-C170CKT	1	ea.	D1	LED-GaAs RED, SMD, 2x1.25mm, 100mW, 40mA, 10mcd, RoHS	LITEON/VISHAY	LTST-C170CKT
2N7002-7-F-T	1	ea.	Q1	TRANSISTOR, N-CHANNEL, 3 LD, SOT-23, 60V, 115mA, RoHS	DIODES, INC.	2N7002-7-F
H2511-00200-1/10W1-T	1	ea.	R3	RES, SMD, 0603, 20Ω, 1/10W, 1%, TF, RoHS	PANASONIC	ERJ-3EKF20R0V
H2511-00R00-1/10W-T	2	ea.	R10, R11	RES, SM, 0603, 0Ω, 1/10W, 5%, TF, RoHS	GENERIC	
H2511-01003-1/10W1-T	1	ea.	R2	RES, SMD, 0603, 100k, 1/10W, 1%, TF, RoHS	VENKEL	CR0603-10W-1003FT
H2511-02001-1/10W1-T	1	ea.	R5	RES, SMD, 0603, 2k, 1/10W, 1%, TF, RoHS	KOA	RK73H1JTTD2001F
H2511-02003-1/10W1-T	4	ea.	R1, R4, R6, R7	RES, SMD, 0603, 200k, 1/10W, 1%, TF, RoHS	VENKEL	CR0603-10W-2003FT
H2511-06982-1/10W1-T	1	ea.	R14	RES, SMD, 0603, 69.8k, 1/10W, 1%, TF, RoHS	VENKEL	CR0603-10W-6982FT
H2511-09532-1/10W1-T	1	ea.	R12	RES, SMD, 0603, 95.3k, 1/10W, 1%, TF, RoHS	VENKEL	CR0603-10W-9532FT
H2511-DNP	0	ea.	R8, R9	RES, SMD, 0603, DNP-PLACE HOLDER, RoHS		
GT11MSCBE-T	2	ea.	SW1, SW2	SWITCH-TOGGLE, SMD, 6 PIN, SPDT, 2POS, ON-ON, RoHS	ITT INDUSTRIES/ C&K DIVISION	GT11MSCBE

ISL78233EVAL1Z, ISL78234EVAL1Z, and ISL78235EVAL1Z Board Layouts

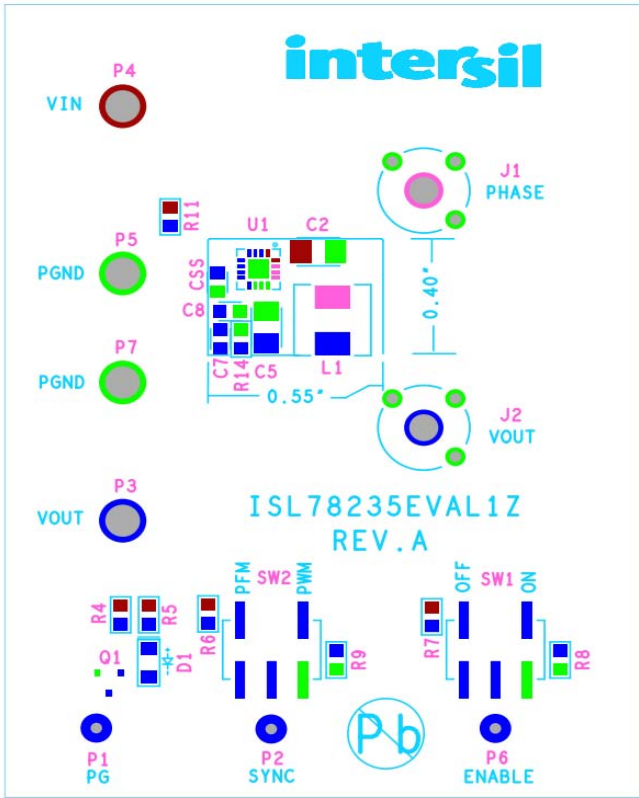

FIGURE 3. TOP LAYER SILKSCREEN

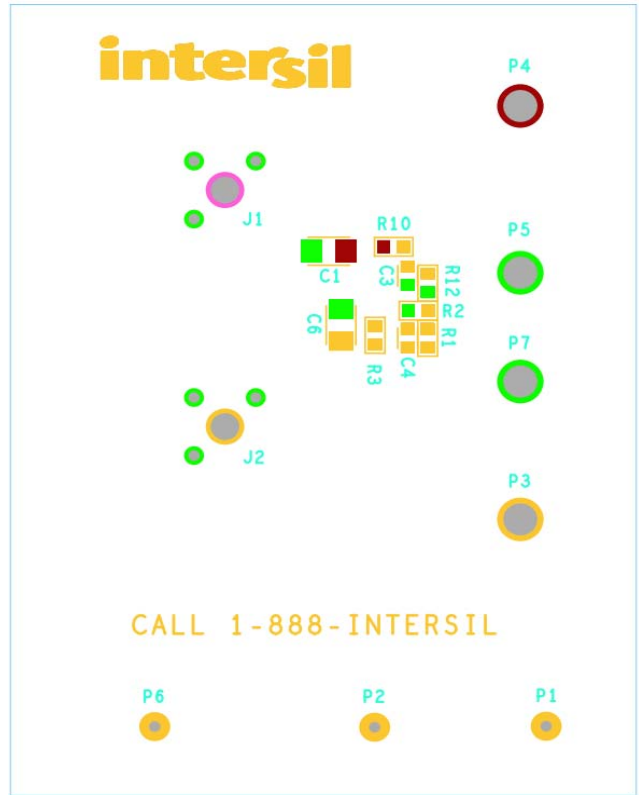

FIGURE 4. BOTTOM LAYER SILKSCREEN

NOTES:

- 5. ISL78233 board silkscreen name is ISL78233EVAL1Z
- 6. ISL78234 board silkscreen name is ISL78234EVAL1Z

ISL78233EVAL1Z, ISL78234EVAL1Z, and ISL78235EVAL1Z Board Layouts (Continued)

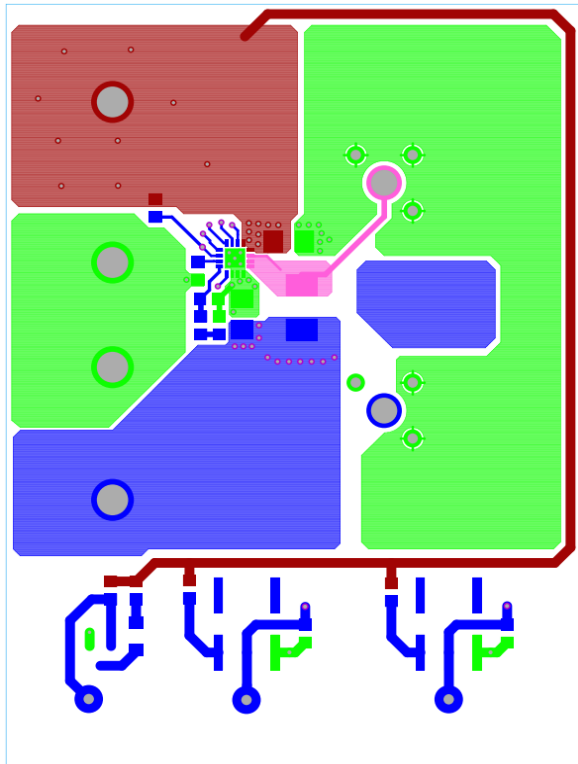

FIGURE 5. LAYER 1 PCB

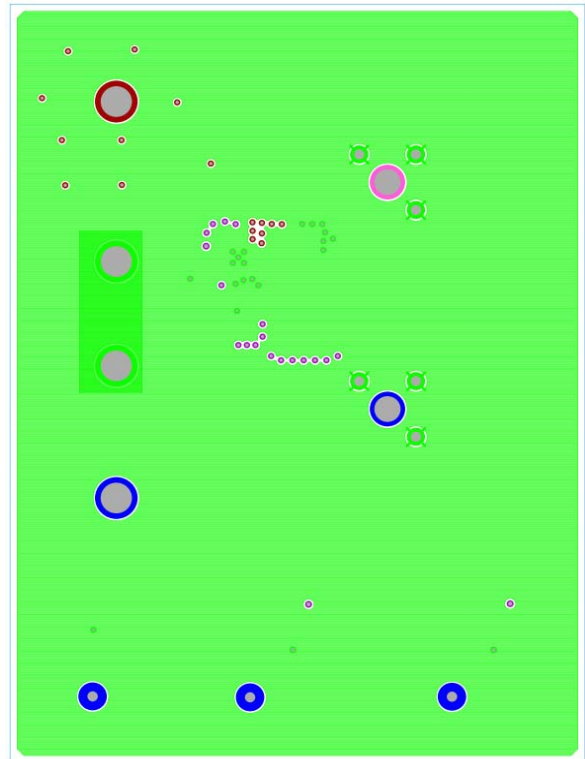

FIGURE 6. LAYER 2 PCB

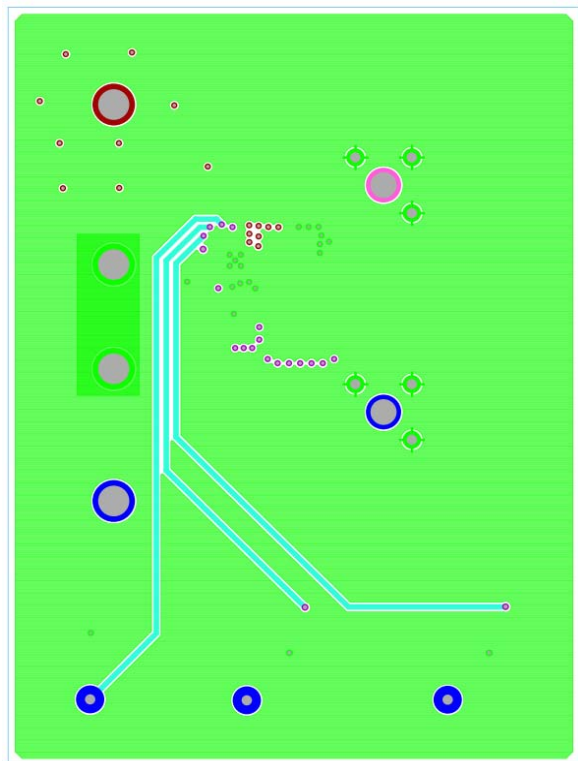

FIGURE 7. LAYER 3 PCB

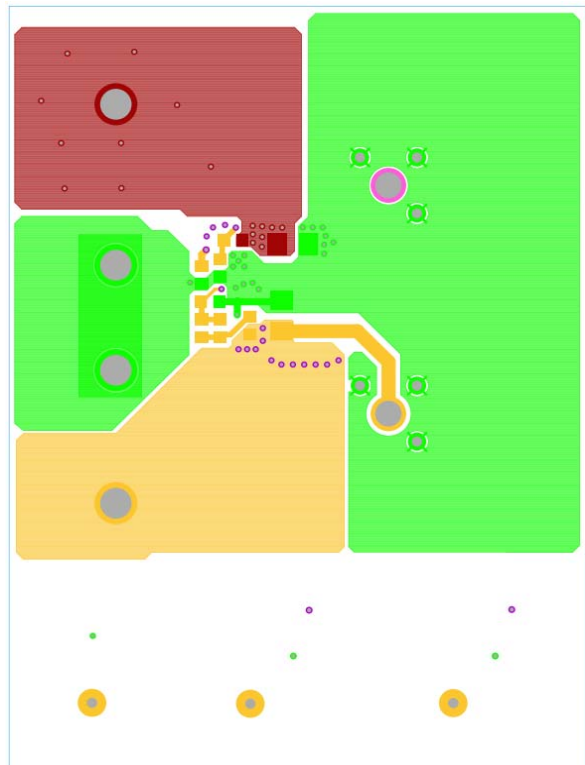

FIGURE 8. LAYER 4 PCB

Typical Performance Curves

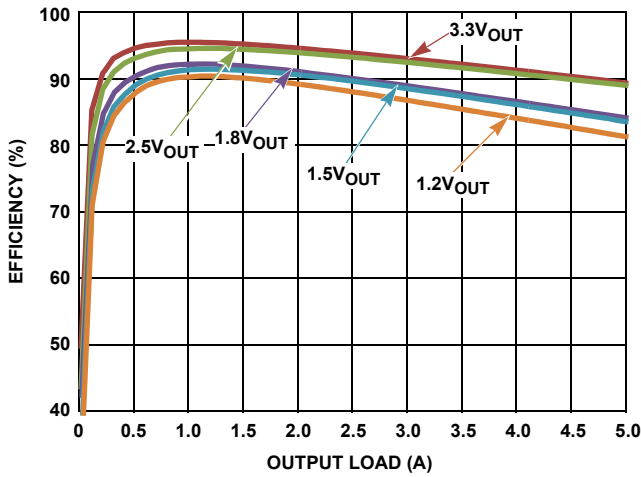

FIGURE 9. EFFICIENCY vs LOAD (5VIN; SYNC = VDD)

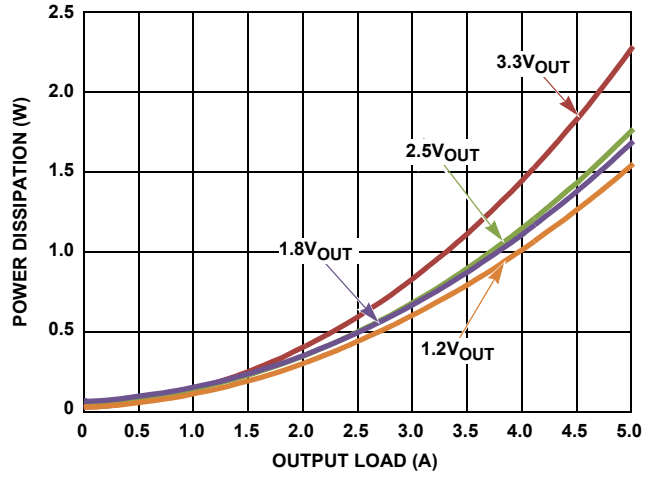

FIGURE 10. POWER DISSIPATION vs LOAD (5VIN; SYNC = VDD)

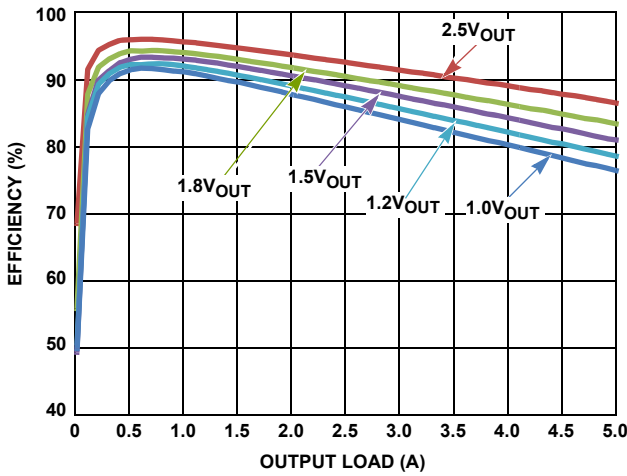

FIGURE 11. EFFICIENCY vs LOAD (3VIN; SYNC = VDD)

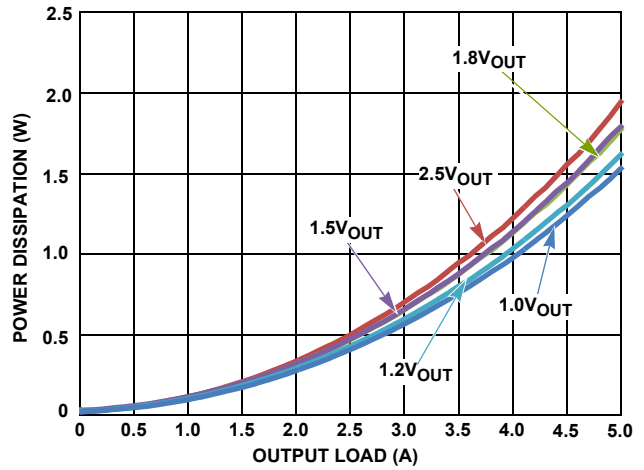

FIGURE 12. POWER DISSIPATION vs LOAD (3VIN; SYNC = VDD)

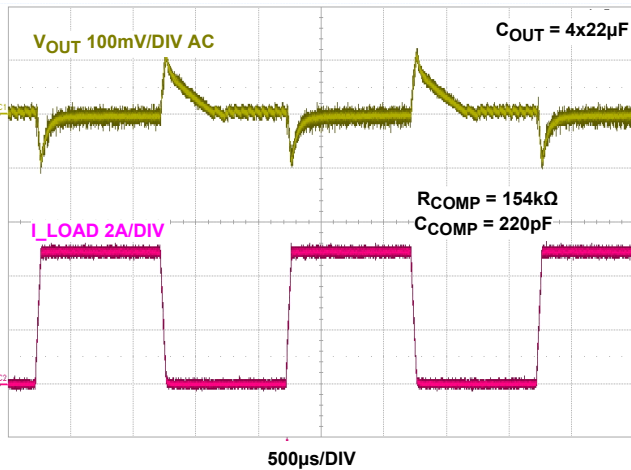

FIGURE 13. LOAD TRANSIENT 0A TO 5A; 0.5A/μs (SYNC = GND)

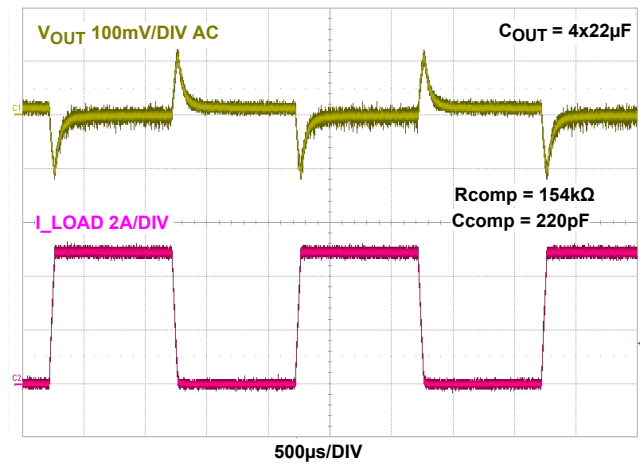

FIGURE 14. LOAD TRANSIENT 0A TO 5A; 0.5A/μs (SYNC = VDD)

Notice

1. Descriptions of circuits, software and other related information in this document are provided only to illustrate the operation of semiconductor products and application examples. You are fully responsible for the incorporation or any other use of the circuits, software, and information in the design of your product or system. Renesas Electronics disclaims any and all liability for any losses and damages incurred by you or third parties arising from the use of these circuits, software, or information.
2. Renesas Electronics hereby expressly disclaims any warranties against and liability for infringement or any other claims involving patents, copyrights, or other intellectual property rights of third parties, by or arising from the use of Renesas Electronics products or technical information described in this document, including but not limited to, the product data, drawings, charts, programs, algorithms, and application examples.
3. No license, express, implied or otherwise, is granted hereby under any patents, copyrights or other intellectual property rights of Renesas Electronics or others.
4. You shall not alter, modify, copy, or reverse engineer any Renesas Electronics product, whether in whole or in part. Renesas Electronics disclaims any and all liability for any losses or damages incurred by you or third parties arising from such alteration, modification, copying or reverse engineering.
5. Renesas Electronics products are classified according to the following two quality grades: "Standard" and "High Quality". The intended applications for each Renesas Electronics product depends on the product's quality grade, as indicated below.
"Standard": Computers; office equipment; communications equipment; test and measurement equipment; audio and visual equipment; home electronic appliances; machine tools; personal electronic equipment; industrial robots; etc.
"High Quality": Transportation equipment (automobiles, trains, ships, etc.); traffic control (traffic lights); large-scale communication equipment; key financial terminal systems; safety control equipment; etc.
Unless expressly designated as a high reliability product or a product for harsh environments in a Renesas Electronics data sheet or other Renesas Electronics document, Renesas Electronics products are not intended or authorized for use in products or systems that may pose a direct threat to human life or bodily injury (artificial life support devices or systems; surgical implantations; etc.), or may cause serious property damage (space system; undersea repeaters; nuclear power control systems; aircraft control systems; key plant systems; military equipment; etc.). Renesas Electronics disclaims any and all liability for any damages or losses incurred by you or any third parties arising from the use of any Renesas Electronics product that is inconsistent with any Renesas Electronics data sheet, user's manual or other Renesas Electronics document.
6. When using Renesas Electronics products, refer to the latest product information (data sheets, user's manuals, application notes, "General Notes for Handling and Using Semiconductor Devices" in the reliability handbook, etc.), and ensure that usage conditions are within the ranges specified by Renesas Electronics with respect to maximum ratings, operating power supply voltage range, heat dissipation characteristics, installation, etc. Renesas Electronics disclaims any and all liability for any malfunctions, failure or accident arising out of the use of Renesas Electronics products outside of such specified ranges.
7. Although Renesas Electronics endeavors to improve the quality and reliability of Renesas Electronics products, semiconductor products have specific characteristics, such as the occurrence of failure at a certain rate and malfunctions under certain use conditions. Unless designated as a high reliability product or a product for harsh environments in a Renesas Electronics data sheet or other Renesas Electronics document, Renesas Electronics products are not subject to radiation resistance design. You are responsible for implementing safety measures to guard against the possibility of bodily injury, injury or damage caused by fire, and/or danger to the public in the event of a failure or malfunction of Renesas Electronics products, such as safety design for hardware and software, including but not limited to redundancy, fire control and malfunction prevention, appropriate treatment for aging degradation or any other appropriate measures. Because the evaluation of microcomputer software alone is very difficult and impractical, you are responsible for evaluating the safety of the final products or systems manufactured by you.
8. Please contact a Renesas Electronics sales office for details as to environmental matters such as the environmental compatibility of each Renesas Electronics product. You are responsible for carefully and sufficiently investigating applicable laws and regulations that regulate the inclusion or use of controlled substances, including without limitation, the EU RoHS Directive, and using Renesas Electronics products in compliance with all these applicable laws and regulations. Renesas Electronics disclaims any and all liability for damages or losses occurring as a result of your noncompliance with applicable laws and regulations.
9. Renesas Electronics products and technologies shall not be used for or incorporated into any products or systems whose manufacture, use, or sale is prohibited under any applicable domestic or foreign laws or regulations. You shall comply with any applicable export control laws and regulations promulgated and administered by the governments of any countries asserting jurisdiction over the parties or transactions.
10. It is the responsibility of the buyer or distributor of Renesas Electronics products, or any other party who distributes, disposes of, or otherwise sells or transfers the product to a third party, to notify such third party in advance of the contents and conditions set forth in this document.
11. This document shall not be reprinted, reproduced or duplicated in any form, in whole or in part, without prior written consent of Renesas Electronics.
12. Please contact a Renesas Electronics sales office if you have any questions regarding the information contained in this document or Renesas Electronics products.
(Note 1) "Renesas Electronics" as used in this document means Renesas Electronics Corporation and also includes its directly or indirectly controlled subsidiaries.
(Note 2) "Renesas Electronics product(s)" means any product developed or manufactured by or for Renesas Electronics.

(Rev.4.0-1 November 2017)



SALES OFFICES

Renesas Electronics Corporation

<http://www.renesas.com>

Refer to "<http://www.renesas.com/>" for the latest and detailed information.

Renesas Electronics America Inc.
1001 Murphy Ranch Road, Milpitas, CA 95035, U.S.A.
Tel: +1-408-432-8888, Fax: +1-408-434-5351

Renesas Electronics Canada Limited
9251 Yonge Street, Suite 8309 Richmond Hill, Ontario Canada L4C 9T3
Tel: +1-905-237-2004

Renesas Electronics Europe Limited
Dukes Meadow, Millboard Road, Bourne End, Buckinghamshire, SL8 5FH, U.K
Tel: +44-1628-651-700, Fax: +44-1628-651-804

Renesas Electronics Europe GmbH
Arcadiastrasse 10, 40472 Düsseldorf, Germany
Tel: +49-211-6503-0, Fax: +49-211-6503-1327

Renesas Electronics (China) Co., Ltd.
Room 1709 Quantum Plaza, No.27 ZhichunLu, Haidian District, Beijing, 100191 P. R. China
Tel: +86-10-8235-1155, Fax: +86-10-8235-7679

Renesas Electronics (Shanghai) Co., Ltd.
Unit 301, Tower A, Central Towers, 555 Langao Road, Putuo District, Shanghai, 200333 P. R. China
Tel: +86-21-2226-0888, Fax: +86-21-2226-0999

Renesas Electronics Hong Kong Limited
Unit 1601-1611, 16/F., Tower 2, Grand Century Place, 193 Prince Edward Road West, Mongkok, Kowloon, Hong Kong
Tel: +852-2265-6688, Fax: +852-2886-9022

Renesas Electronics Taiwan Co., Ltd.
13F, No. 363, Fu Shing North Road, Taipei 10543, Taiwan
Tel: +886-2-8175-9600, Fax: +886-2-8175-9670

Renesas Electronics Singapore Pte. Ltd.
80 Bendemeer Road, Unit #06-02 Hyflux Innovation Centre, Singapore 339949
Tel: +65-6213-0200, Fax: +65-6213-0300

Renesas Electronics Malaysia Sdn.Bhd.
Unit 1207, Block B, Menara Amcorp, Amcorp Trade Centre, No. 18, Jln Persiaran Barat, 46050 Petaling Jaya, Selangor Darul Ehsan, Malaysia
Tel: +60-3-7955-9390, Fax: +60-3-7955-9510

Renesas Electronics India Pvt. Ltd.
No.777C, 100 Feet Road, HAL 2nd Stage, Indiranagar, Bangalore 560 038, India
Tel: +91-80-67208700, Fax: +91-80-67208777

Renesas Electronics Korea Co., Ltd.
17F, KAMCO Yangjae Tower, 262, Gangnam-daero, Gangnam-gu, Seoul, 06265 Korea
Tel: +82-2-558-3737, Fax: +82-2-558-5338