

ISL6406EVAL1, ISL6406EVAL2, ISL6406EVAL3

PWM Controller Evaluation Boards

AN1031
Rev 1.00
July 9, 2008

Introduction

The ISL6406, ISL6426 is a highly efficient, adjustable frequency, synchronous buck switching regulator optimized for generating lower voltages for the distributed DC/DC architecture required for DSP, memory and core communication processors in Broadband Gateway applications. The ISL6406 offers an adjustable output voltage, while the ISL6426 provides a fixed 1.8V output.

The wide programmable switching frequency range of 100kHz to 700kHz allows the use of small surface mount inductors and capacitors. The device also provides external frequency synchronization making it an ideal choice for DC/DC converter applications. This combination of features and the available miniature packaging enables the design of a high performance power supply in an extremely small PCB area, ideal for portable instruments, access devices and other applications requiring high efficiency.

There are two MOSFET drivers for use in synchronous-rectified Buck converters. The ISL6406 is capable of regulating the output voltage while the DC/DC converter is sinking current. All these features are packaged in a 16 lead SOIC, a thin shrunk 16 lead TSSOP or a 16 lead 4x4[mm] QFN (MLFP). More complete descriptions of the ISL6406 can be found in the data sheet [1].

This application note details the use of the ISL6406 in DC-DC converter applications requiring a tightly regulated, fixed output voltage. Any low-cost application requiring a DC/DC converter can benefit from one of the designs presented in this application note.

ISL6406, ISL6426 Reference Designs

The ISL6406, ISL6426 evaluation board highlights the operation of the IC in an embedded application. There are three evaluation boards from which to choose.

TABLE 1. EVALUATION BOARDS

BOARD NAME	IC	PACKAGE
ISL6406EVAL1	ISL6406/26CV	16 Ld TSSOP
ISL6406EVAL2	ISL6406/26CR	16 Ld QFN
ISL6406EVAL3	ISL6406/26CB	16 Ld SOIC

All evaluation boards have the same output filter, compensation components and MOSFETs. They are configured for an output of 2.5V with a maximum load of 5A. The evaluation board is built with the ISL6406 and is shipped with ISL6426 samples. Evaluation of the ISL6426 may be performed by replacing the ISL6406.

Quick Start Evaluation

The evaluation board is shipped “ready to use” right from the box. The board accepts a 3.3V input from a standard power supply. The output can be exercised through the use of an external load.

There are posts available on the board for introducing power to the board and for drawing current from the regulated output. Two probe points are also available, which provide kelvin connections to CPVOUT (TP1) and CT1 (P6).

The SYNC/EN pin may be probed from P5.

Recommended Test Equipment

- An adjustable 0V to 5V, 5A capable bench power supply
- An electronic load
- Four channel oscilloscope with probes
- Precision digital multimeter

Power and Load Connections

There are 2 sets of terminals that are used for supplying the input voltage and loading the output.

Input Voltage - Connect the positive lead of the adjustable bench power supply to the 3.3V post (P1). Connect the ground lead of the supply to the GND post (P2).

Output Loading, Sourcing Current - Connect the positive terminal of the electronic load to the VOUT post (P3). Connect the return terminal of the same load to the GND post (P4).

Start-up

There are two distinct start-up methods for the ISL6406 regulator. The first method is invoked through the application of power to the IC. The soft-start feature allows for a controlled turn-on of the output once the Power On Reset (POR) threshold of the input voltage has been reached. Figure 1 (on the next page) shows the start-up profile of the regulator in relation to the start-up of the 3.3V input supply and the bias supply generated by the charge pump.

The second method of start-up is through the use of the Enable/Shutdown feature. Holding the SYNC/EN pin on the ISL6406, ISL6426 below 0.8V will disable the regulator by forcing both the upper and lower MOSFETs off. Releasing the pin allows the regulator to start up.

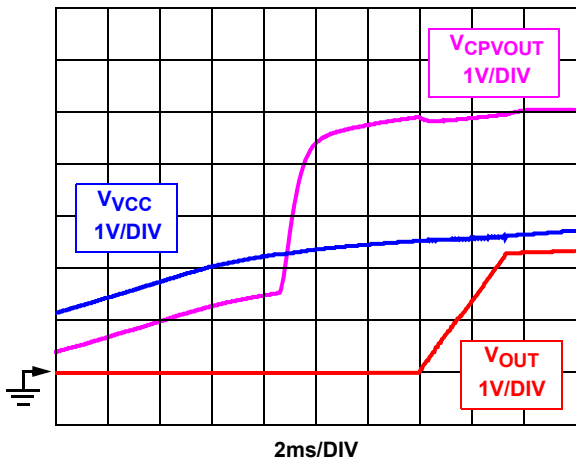

FIGURE 1. START-UP FROM POR

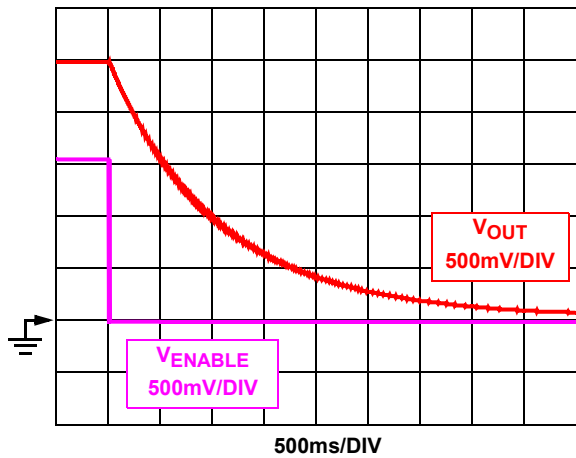

FIGURE 2. SHUTDOWN WITH NO LOAD (ISL6406)

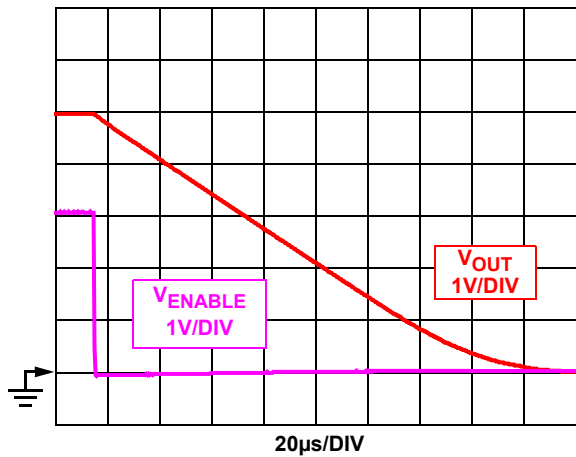

FIGURE 3. SHUTDOWN WITH FULL LOAD (ISL6406)

Shutdown

As discussed in the previous section, if the SYNC/EN (P5) pin is pulled down and held below 0.8V, the regulator will be turned off. Figure 2 shows the shutdown profile of the regulator with no load applied. Figure 3 shows the shutdown of the regulator under full load.

Output Performance

All three evaluation boards have the same schematic and are designed to provide a 2.5V/5A output. The switching frequency is set at 300kHz, which can be adjusted from 100kHz to 700kHz using a resistor, R5, connected to the RT pin.

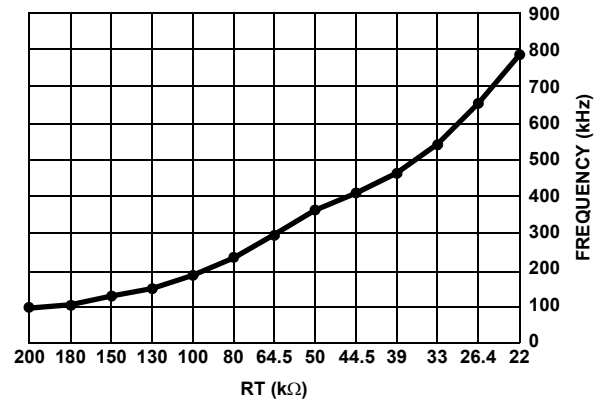

FIGURE 4. RT vs FREQUENCY

The ISL6406, ISL6426 can be synchronized to an external frequency by connecting an external clock source to SYNC/EN (P5). The external sync clock may range from 100kHz to well over 750kHz.

Figure 5 shows the ripple voltage on the output of the regulator.

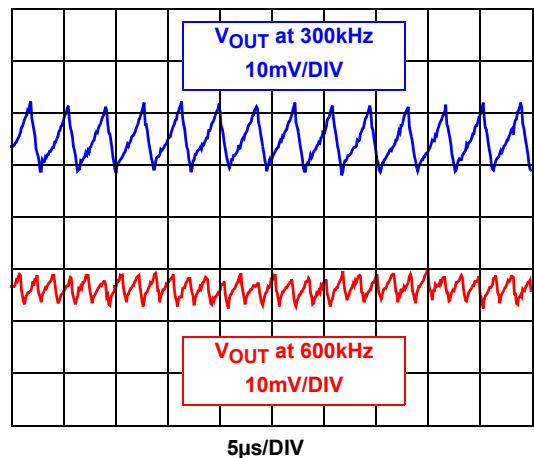

FIGURE 5. OUTPUT RIPPLE VOLTAGE

Conclusion

Compact and highly efficient regulators can be easily implemented with the ISL6406 and ISL6426. The IC offers high-performance features with a small footprint, which makes it ideal for many low-voltage DC/DC power solutions.

References

For Intersil documents available on the web, see <http://www.intersil.com/>

[1] *ISL6406, ISL6426 Data Sheet*, Intersil Corporation, File No. FN9073.

Evaluation Board Schematic

NOTE: All evaluation boards share the same schematic.

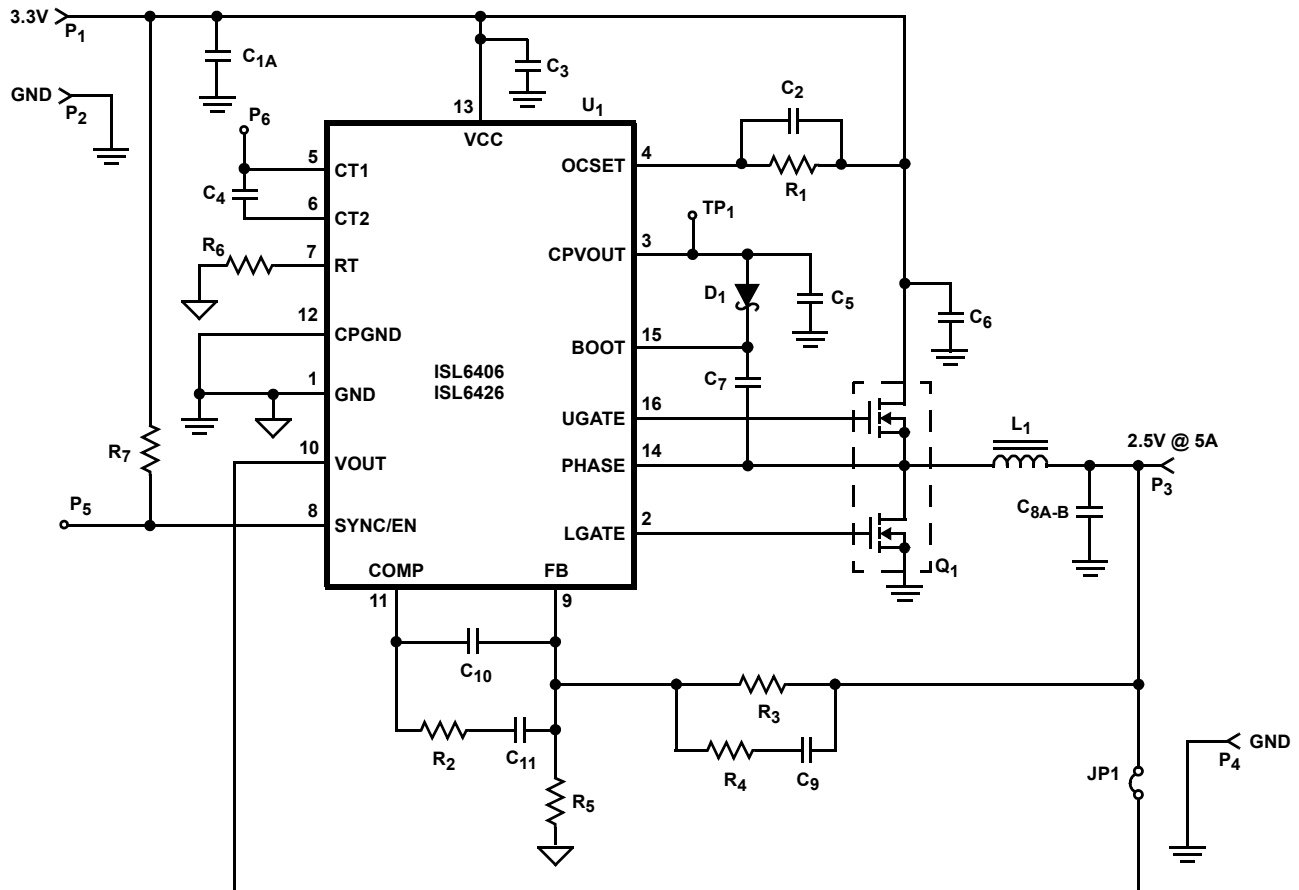

NOTE: Remove R3, R4, C9, and R5 from the board for ISL6426 evaluation.

Bill of Materials

TABLE 2. EVALUATION BOARD SPECIFIC BILL OF MATERIALS

REFERENCE	QTY	PART NUMBER	PART TYPE	DESCRIPTION	PACKAGE	VENDOR
ISL6406EVAL1						
U1	1	ISL6406CV	IC	Synchronous Buck PWM Controller	16 Lead TSSOP	Intersil
ISL6426EVAL1						
U1	1	ISL6426CV	IC	Synchronous Buck PWM Controller	16 Lead TSSOP	Intersil
ISL6406EVAL2						
U1	1	ISL6406CR	IC	Synchronous Buck PWM Controller	16 Lead 4x4 QFN	Intersil
ISL6426EVAL2						
U1	1	ISL6426CR	IC	Synchronous Buck PWM Controller	16 Lead 4x4 QFN	Intersil
ISL6406EVAL3						
U1	1	ISL6406CB	IC	Synchronous Buck PWM Controller	16 Lead SOIC	Intersil
ISL6426EVAL3						
U1	1	ISL6426CB	IC	Synchronous Buck PWM Controller	16 Lead SOIC	Intersil

Bill of Materials**TABLE 3. EVALUATION BOARD COMMON BILL OF MATERIALS**

REFERENCE	QTY	PART NUMBER	PART TYPE	DESCRIPTION	PACKAGE	VENDOR
Q1	1	ITF86110DK8T	Dual MOSFET	N-channel, 30V, 6A, 0.028Ω	SOIC-8	Fairchild
		FDS6912A	Alternate Part			
D1	1	MMSD4148T1	Diode	100V, 300mA	SOD123	ON-Semi
L1	1	ETQP6F1R0SFA	Inductor	1.0μH, 30%, 14.2A	SMD	Panasonic ETQ-P series
CAPACITORS						
C1A, C1B, C8A, C8B	4	EEF-UE0J151R	Capacitor, Alu. Elec.	150μF, 20%, 6.3V, 0.015Ω	SMD SP_CAP_UE	Panasonic
C2	1	08053C102KAT2A	Capacitor, Ceramic	1000pF, 10%, 25V	SM_0805	AVX
C3, C7	2	08053C104MAT2A	Capacitor, Ceramic	0.1μF, 20%, 25V	SM_0805	AVX
C4	1	08053C224MAT2A	Capacitor, Ceramic	0.22μF, 20%, 25V	SM_0805	AVX
C5	1	1210YD106KAT2A	Capacitor, Ceramic	10μF, 10%, 16V	SM_0805	AVX
C6	1	08053C105MAT2A	Capacitor, Ceramic	1μF, 20%, 25V	SM_0805	AVX
C9	1	08053C822MAT2A	Capacitor, Ceramic	8200pF, 20%, 25V	SM_0805	AVX
C10	1	08053A033KAT2A	Capacitor, Ceramic, NPO	33pF, 10%, 25V	SM_0805	AVX
C11	1	08053C562MAT2A	Capacitor, Ceramic	5600pF, 20%, 25V	SM_0805	AVX
RESISTORS						
R1	1		Resistor, Film	9.76k, 1%, 1/10 Watt	SM_0805	Panasonic
R2	1		Resistor, Film	6.49k, 1%, 1/10 Watt	SM_0805	Panasonic
R3	1		Resistor, Film	2.26k, 1%, 1/10 Watt	SM_0805	Panasonic
R4	1		Resistor, Film	124, 1%, 1/10 Watt	SM_0805	Panasonic
R5	1		Resistor, Film	1.07k, 1%, 1/10 Watt	SM_0805	Panasonic
R6	1		Resistor, Film	64.9k, 1%, 1/10 Watt	SM_0805	Panasonic
R7	1		Resistor, Film	100k, 1%, 1/10 Watt	SM_0805	Panasonic
OTHERS						
SP1	1	131-5031-00	Terminal, Scope Probe	Terminal, Scope Probe		Tektronix
P1 - P6	6	1514-2	Turrett Post	Terminal post, through hole, 1/4 inch tall	PTH	Keystone
TP1	1	5002	TEST POINT vertical, white	PC test jack	PTH	Keystone
JP1	1	68000-236-1X2	Header	1X2 Break Strip GOLD		
JP1	1	S9001-ND	Jumper	2 pin jumper		Digikey
	4		Bumpers			

ISL6406, ISL6426 EVAL1 Layers

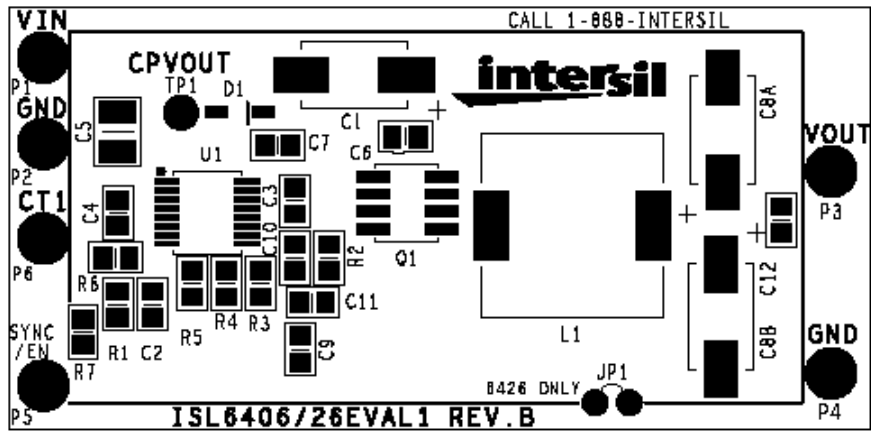

FIGURE 6. ISL6406EVAL1 - TOP SILK PRINT

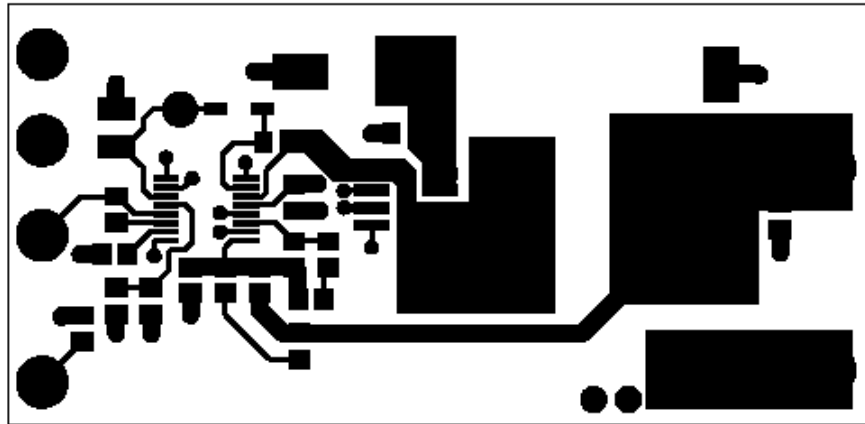

FIGURE 7. ISL6406EVAL1 - TOP LAYER

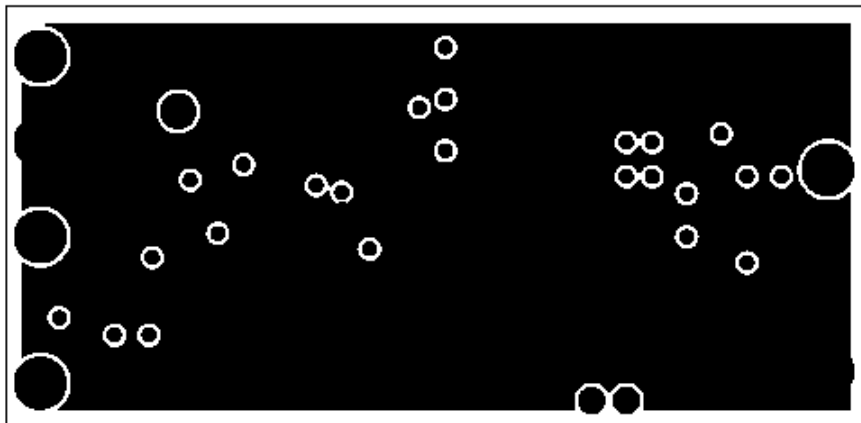

FIGURE 8. ISL6406EVAL1 - LAYER 2

ISL6406, ISL6426 EVAL1 Layers (Continued)

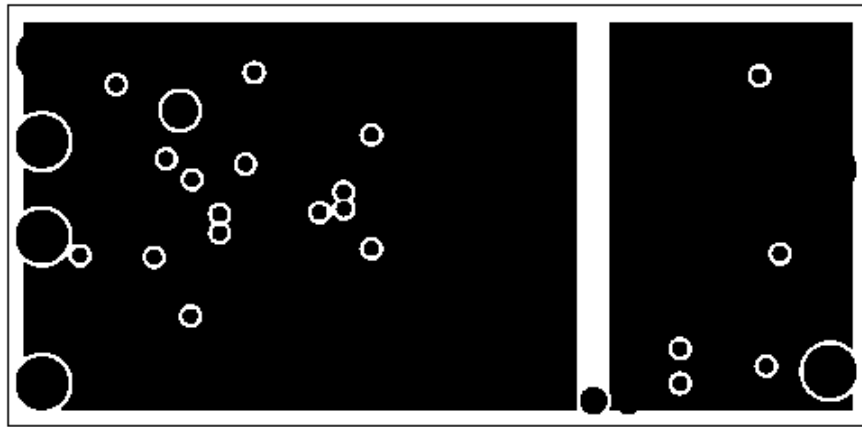

FIGURE 9. ISL6406EVAL1 - LAYER 3

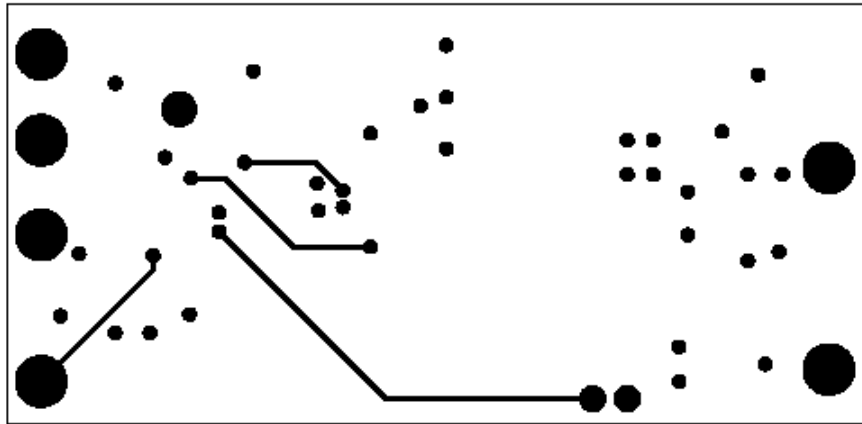

FIGURE 10. ISL6406EVAL1 - LAYER 4

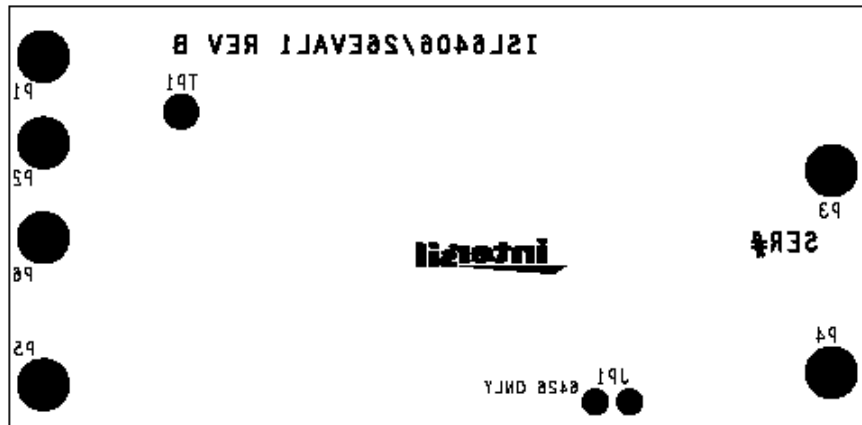

FIGURE 11. ISL6406EVAL1 - BOTTOM LAYER

ISL6406, ISL6426 EVAL2 Layers

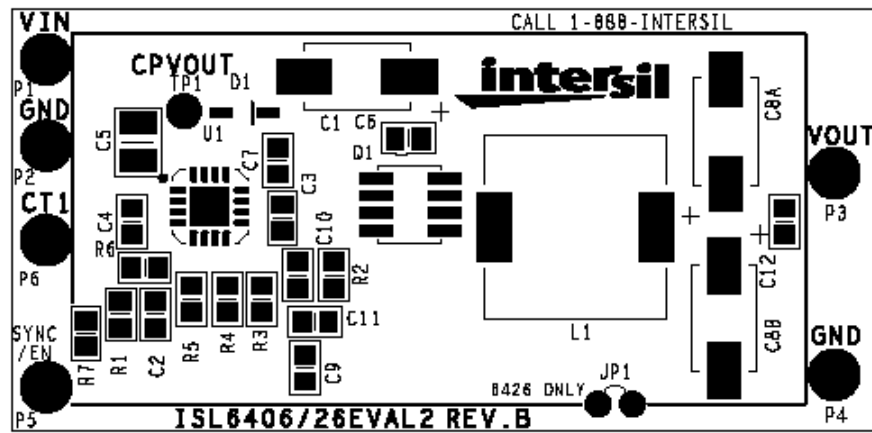

FIGURE 12. ISL6406EVAL2 - TOP SILK PRINT

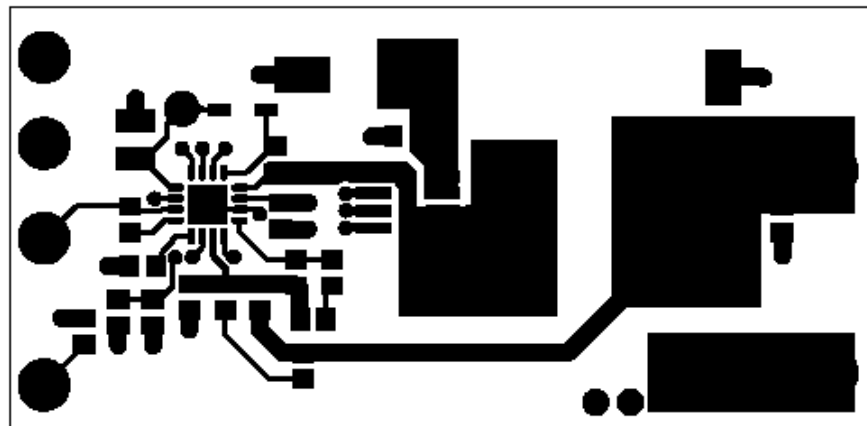

FIGURE 13. ISL6406EVAL2 - TOP LAYER

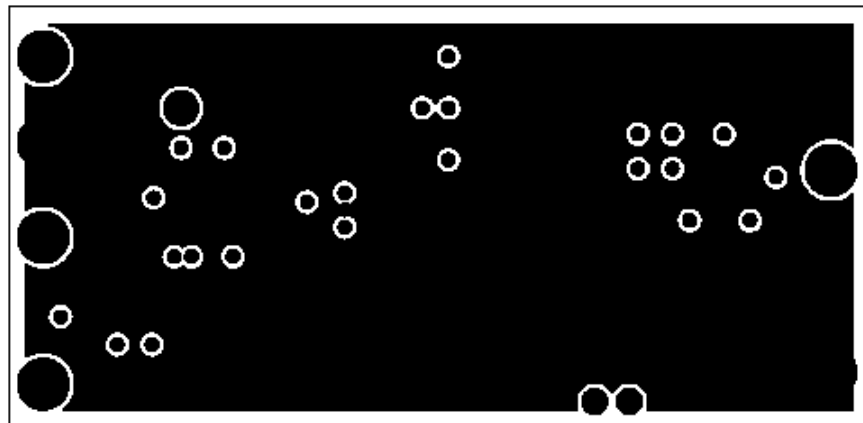

FIGURE 14. ISL6406EVAL2 - LAYER 2

ISL6406, ISL6426 EVAL2 Layers (Continued)

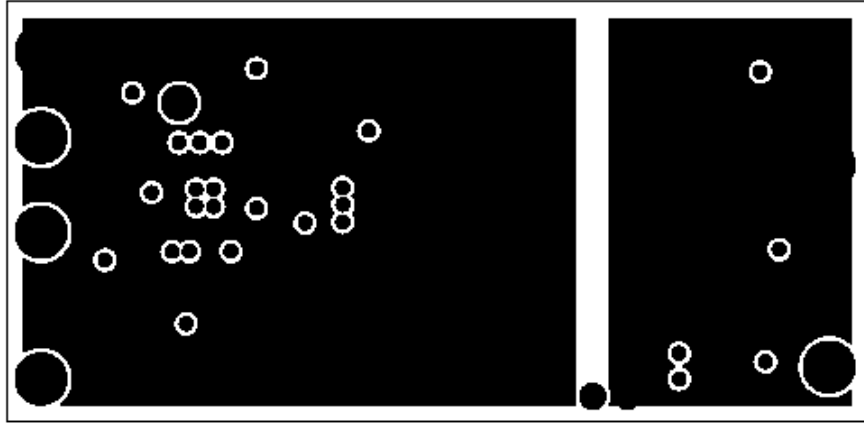

FIGURE 15. ISL6406EVAL2 - LAYER 3

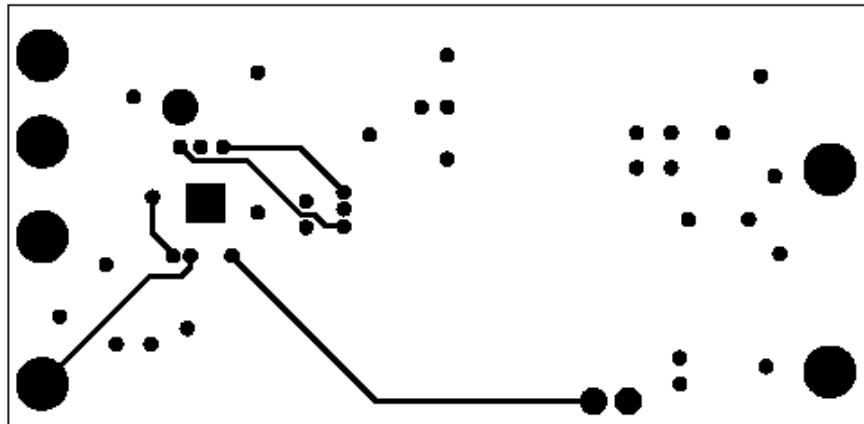

FIGURE 16. ISL6406EVAL2 - LAYER 4

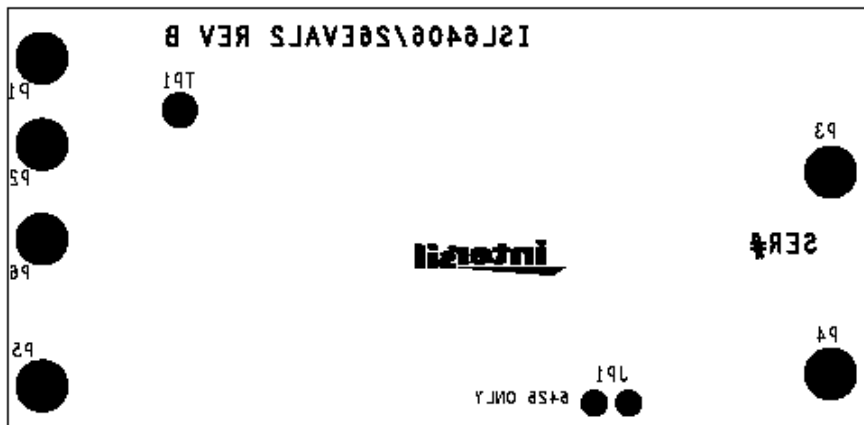

FIGURE 17. ISL6406EVAL2 - BOTTOM LAYER

ISL6406, ISL6426 EVAL3 Layers

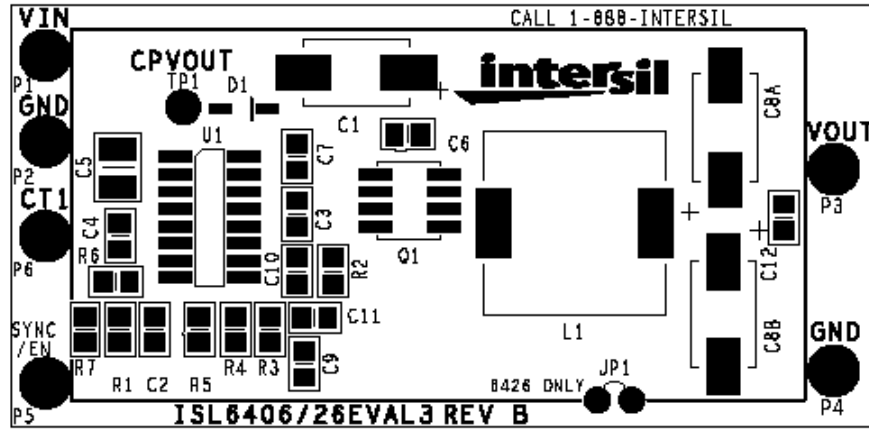

FIGURE 18. ISL6406EVAL3 - TOP SILK PRINT

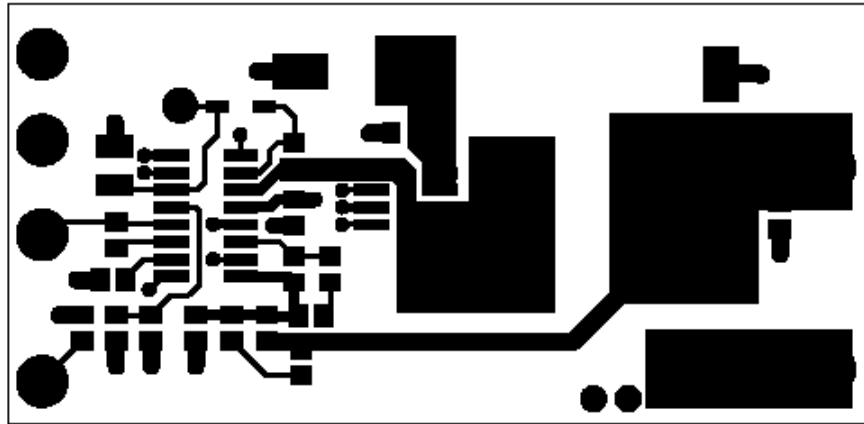

FIGURE 19. ISL6406EVAL3 - TOP LAYER

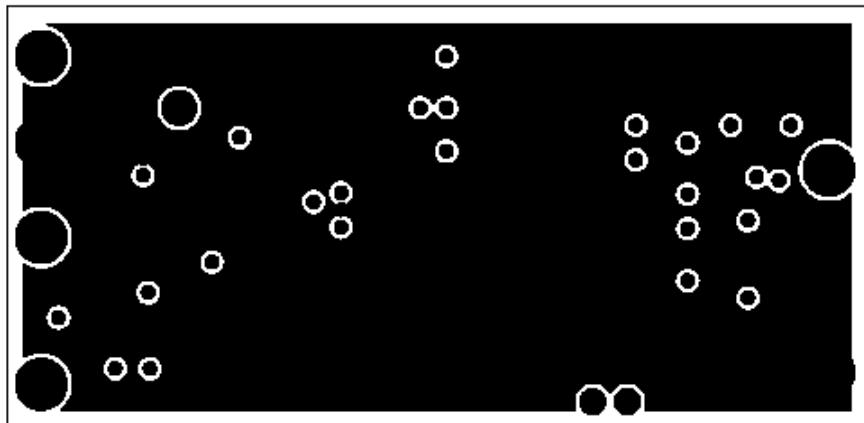

FIGURE 20. ISL6406EVAL3 - LAYER 2

ISL6406, ISL6426 EVAL3 Layers (Continued)

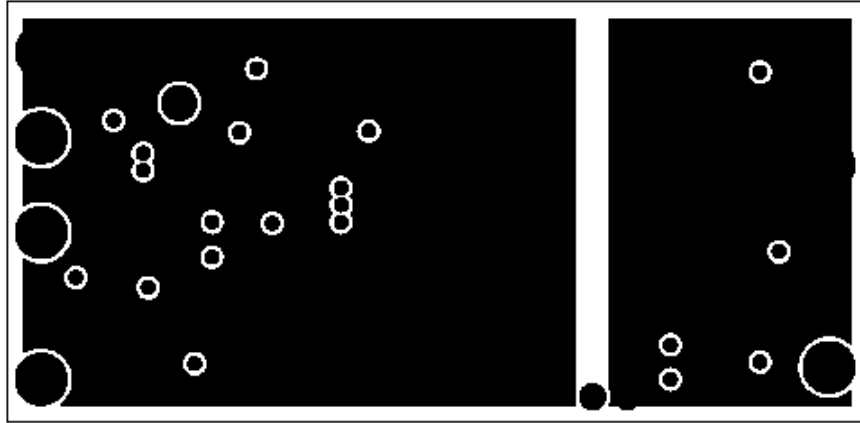

FIGURE 21. ISL6406EVAL3 - LAYER 3

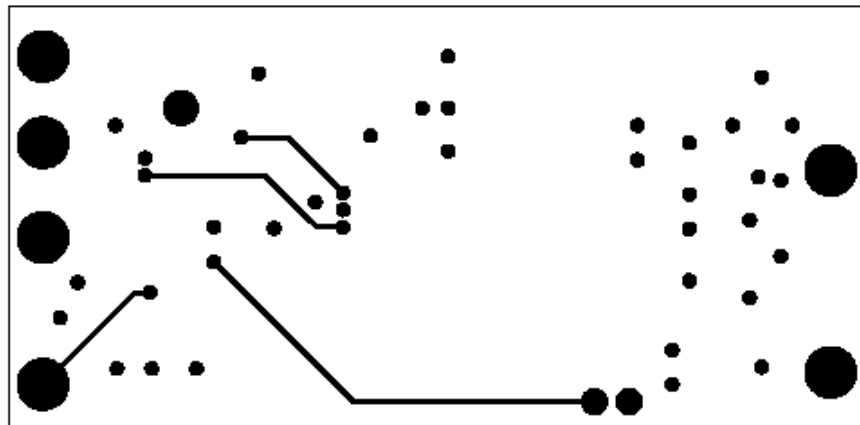

FIGURE 22. ISL6406EVAL3 - LAYER 4

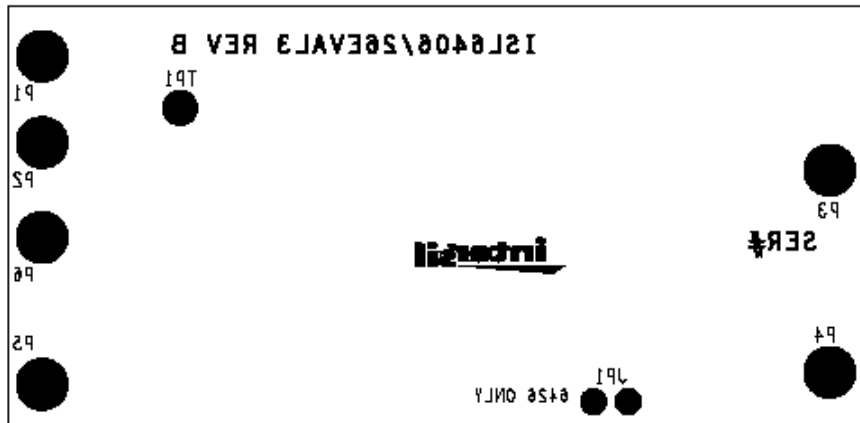

FIGURE 23. ISL6406EVAL3 - BOTTOM LAYER

IMPORTANT NOTICE AND DISCLAIMER

RENESAS ELECTRONICS CORPORATION AND ITS SUBSIDIARIES (“RENESAS”) PROVIDES TECHNICAL SPECIFICATIONS AND RELIABILITY DATA (INCLUDING DATASHEETS), DESIGN RESOURCES (INCLUDING REFERENCE DESIGNS), APPLICATION OR OTHER DESIGN ADVICE, WEB TOOLS, SAFETY INFORMATION, AND OTHER RESOURCES “AS IS” AND WITH ALL FAULTS, AND DISCLAIMS ALL WARRANTIES, EXPRESS OR IMPLIED, INCLUDING, WITHOUT LIMITATION, ANY IMPLIED WARRANTIES OF MERCHANTABILITY, FITNESS FOR A PARTICULAR PURPOSE, OR NON-INFRINGEMENT OF THIRD PARTY INTELLECTUAL PROPERTY RIGHTS.

These resources are intended for developers skilled in the art designing with Renesas products. You are solely responsible for (1) selecting the appropriate products for your application, (2) designing, validating, and testing your application, and (3) ensuring your application meets applicable standards, and any other safety, security, or other requirements. These resources are subject to change without notice. Renesas grants you permission to use these resources only for development of an application that uses Renesas products. Other reproduction or use of these resources is strictly prohibited. No license is granted to any other Renesas intellectual property or to any third party intellectual property. Renesas disclaims responsibility for, and you will fully indemnify Renesas and its representatives against, any claims, damages, costs, losses, or liabilities arising out of your use of these resources. Renesas' products are provided only subject to Renesas' Terms and Conditions of Sale or other applicable terms agreed to in writing. No use of any Renesas resources expands or otherwise alters any applicable warranties or warranty disclaimers for these products.

(Rev.1.0 Mar 2020)

Corporate Headquarters

TOYOSU FORESIA, 3-2-24 Toyosu,
Koto-ku, Tokyo 135-0061, Japan
www.renesas.com

Contact Information

For further information on a product, technology, the most up-to-date version of a document, or your nearest sales office, please visit:
www.renesas.com/contact/

Trademarks

Renesas and the Renesas logo are trademarks of Renesas Electronics Corporation. All trademarks and registered trademarks are the property of their respective owners.