

ISL6228LOEVAL3Z

Evaluation Board

AN1321
Rev 0.00
May 17, 2007

Introduction

The ISL6228LOEVAL3Z evaluation board demonstrates the performance of the ISL6228 dual-channel PWM controller. The ISL6228 features Intersil's Robust Ripple Regulator (R³) technology. Channel-1 output voltage is 1.5V or 1.8V, pending the state of switch S5. Channel-2 output voltage is 1.8V. Each channel has an on-board dynamic-load generator included for evaluating the transient-load response. It applies a 300µs pulse of 8A load across V_{O1} and GND, and also a 300µs pulse of 8A load across V_{O2} and GND.

Contents of this document include:

- Recommended Test Equipment
- Interface Connections
- Test Set-up
- Switch Descriptions
- Test Point Descriptions
- Design Criteria
- Typical Performance
 - Efficiency
 - Start-up
 - Shut-down
 - Steady State, CCM
 - Steady State, DCM
 - Load-transient response
- Evaluation Board Documentation
 - Bill of materials
 - Schematic
 - Silk-screen plots
 - Board layer plots

TABLE 1. DC/DC DESIGN CRITERIA

PARAMETER	VALUE	UNITS
V _{IN}	3.3 to 25	VDC
V _O	0.6 to 5	VDC
Full-load	8	ADC
PWM Frequency	270, 300	kHz

Recommended Equipment

- (QTY 2) Adjustable 25V, 3A Power Supply
- (QTY 1) Fixed 5V, 100mA Power Supply
- (QTY 1) Fixed 12V, 100mA Power Supply
- (QTY 1) Adjustable 20A Constant Current Electronic Load
- (QTY 1) Digital Voltmeter
- (QTY 1) Four-Channel Oscilloscope

Interface Connections

- V_{IN1}: Input voltage to the power stage of Channel-1
 - J14: V_{IN1} positive power input
 - TP20: V_{IN1} positive voltage sense
 - J14: V_{IN1} return power input
 - TP21: V_{IN1} return voltage sense
- V_{IN2}: Input voltage to the power stage of Channel-2
 - J1: V_{IN2} positive power input
 - TP9: V_{IN2} positive voltage sense
 - J2: V_{IN2} return power input
 - TP10: V_{IN2} return voltage sense
- V_{O1}: Regulated output voltage from Channel-1
 - J9: V_{O1} positive power output
 - TP13: V_{O1} positive voltage sense
 - J10: V_{O1} return power output
 - TP14: V_{O1} return voltage sense
- V_{O2}: Regulated output voltage from Channel-2
 - J7: V_{O2} positive power output
 - TP11: V_{O2} positive voltage sense
 - J8: V_{O2} return power output
 - TP12: V_{O2} return voltage sense
- VCC: +5V input voltage
 - TP1: 5V positive input
 - TP2: 5V return input
- +12V: Input voltage for the dynamic-load generator
 - TP15: 12V positive input
 - TP16: 12V return input

Test Set-up

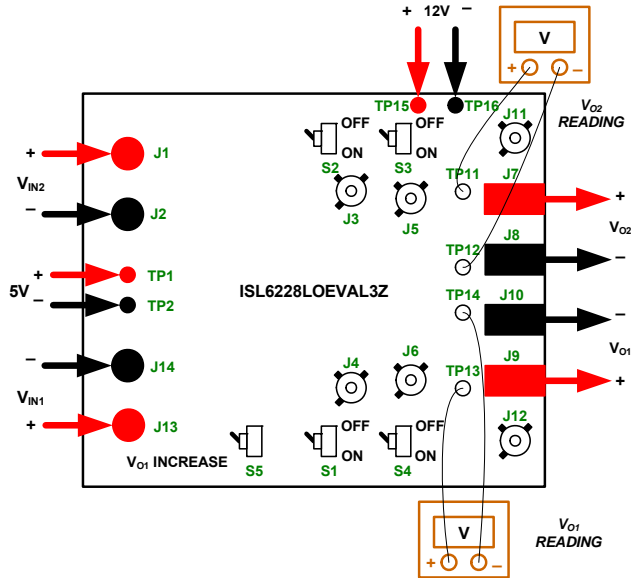

FIGURE 1. TEST SET-UP

Switch Descriptions

- S1: Channel-1 Enable
 - OFF: Short the Channel-1 EN pin to GND (disable PWM)
 - ON: Allow the Channel-1 EN pin to pull-up to +5V (enable PWM)
- S4: Channel-1 Dynamic Load
 - OFF: On-board Channel-1 dynamic load disabled
 - ON: On-board Channel-1 dynamic load enabled
- S5: Channel-1 V_O Increase
 - OFF: V_{O1} is 1.5V, determined by R₁₅ and R₂₃.
 - ON: Parallel R₄₉ with R₁₅. V_{O1} is 1.8V.
- S2: Channel-2 Enable
 - OFF: Short the Channel-2 EN pin to GND (disable PWM)
 - ON: Allow the Channel-2 EN pin to pull-up to +5V (enable PWM)
- S3: Channel-2 Dynamic Load
 - OFF: On-board Channel-2 dynamic load disabled
 - ON: On-board Channel-2 dynamic load enabled

Test-point Descriptions

- J4: Scope-probe socket for measuring PHASE1
- J6: Scope-probe socket for measuring V_{O1}
- J12: Scope-probe socket for measuring the current of the Channel-1 on-board transient-load emulator
- J3: Scope-probe socket for measuring the PHASE2 node
- J5: Scope-probe socket for measuring V_{O2}
- J11: Scope-probe socket for measuring the current of the Channel-2 on-board transient-load emulator
- TP1: Monitor the 5V positive input
- TP2: Monitor the 5V return input
- TP3: Monitor the PGOOD2 pin
- TP4: Monitor the PGOOD1 pin
- TP5: The common node of R₂₄ and R₂₀; Useful for Channel-1 loop gain measurement.
- TP6: The common node of R₂₅ and R₂₃; Useful for Channel-2 loop gain measurement
- TP7: The V_{O1} side of R₂₄; Useful for Channel-1 loop gain measurement.
- TP8: The V_{O2} side of R₂₅; Useful for Channel-1 loop gain measurement.
- TP9: Monitor the V_{IN1} positive input
- TP10: Monitor the V_{IN1} return input
- TP11: Monitor the positive V_{O1} output
- TP12: Monitor the V_{O1} return output
- TP13: Monitor the positive V_{O2} output
- TP14: Monitor the V_{O2} return output
- TP15: Monitor the 12V positive input
- TP16: Monitor the 12V return input
- TP17: Monitor the EN1 pin
- TP18: Monitor the gate of transistor Q₁₈
- TP19: Monitor the EN2 pin
- TP20: Monitor the V_{IN2} positive input
- TP21: Monitor the V_{IN2} return input

Typical Performance

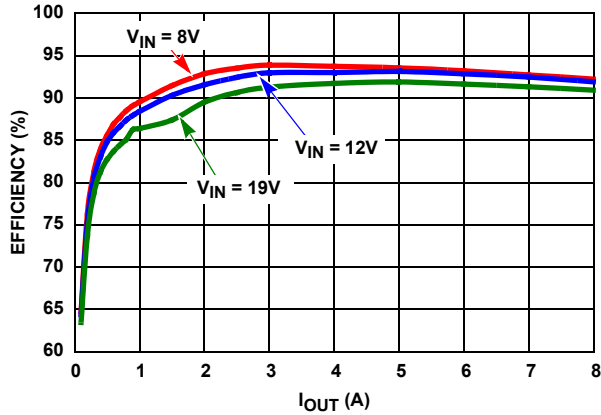

FIGURE 2. CHANNEL-1 EFFICIENCY AT $V_O = 1.5V$

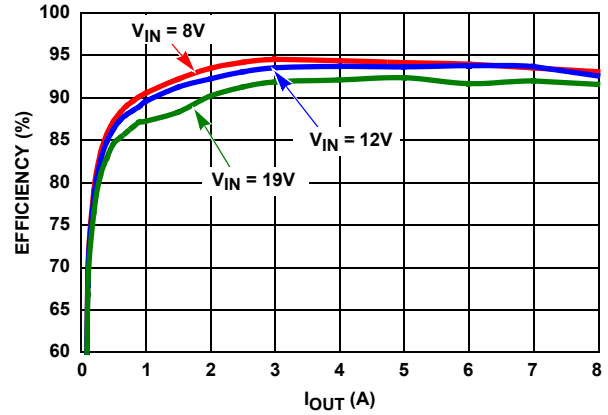

FIGURE 3. CHANNEL-2 EFFICIENCY AT $V_O = 1.8V$

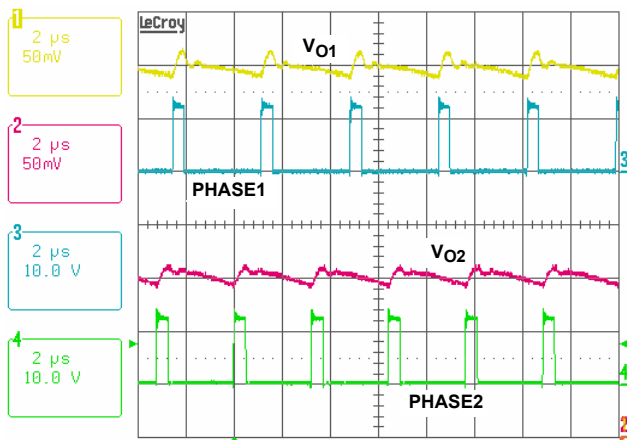

FIGURE 4. CCM STEADY-STATE OPERATION, $V_{IN} = 12V$, $V_{O1} = 1.5V$, $I_{O1} = 3A$, $V_{O2} = 1.8A$, $I_{O2} = 4A$

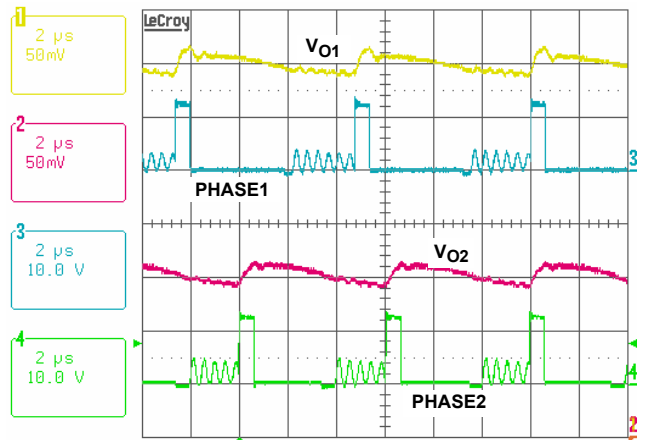

FIGURE 5. DCM STEADY-STATE OPERATION, $V_{IN} = 12V$, $V_{O1} = 1.5V$, $I_{O1} = 1A$, $V_{O2} = 1.8V$, $I_{O2} = 1A$

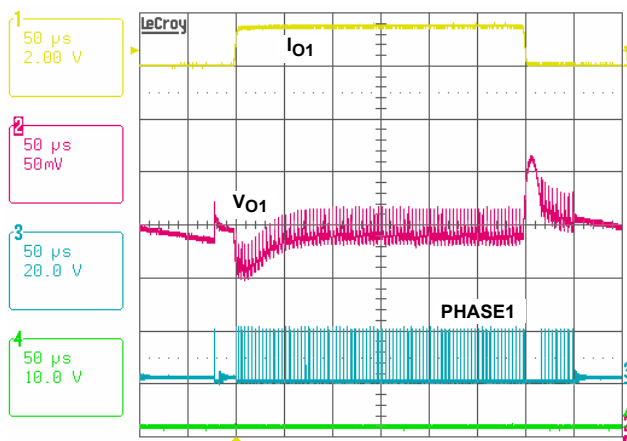

FIGURE 6. TRANSIENT RESPONSE, $V_{IN} = 19V$, $V_O = 1.5V$, $I_O = 0.1A/8.1A @ 2.55A/μs$

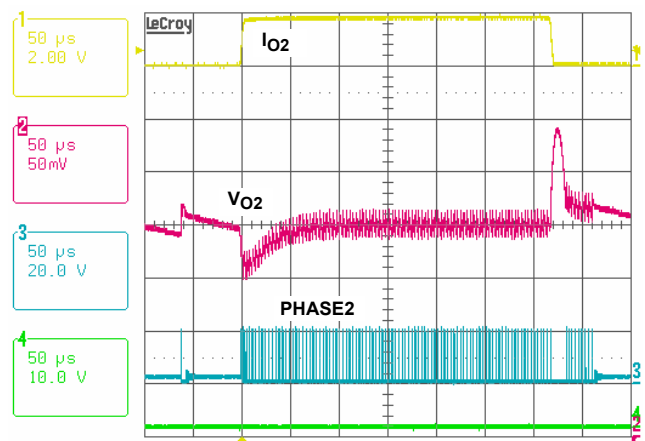

FIGURE 7. TRANSIENT RESPONSE, $V_{IN} = 19V$, $V_O = 1.8V$, $I_O = 0.1A/8.1A @ 2.55A/μs$

Typical Performance (Continued)

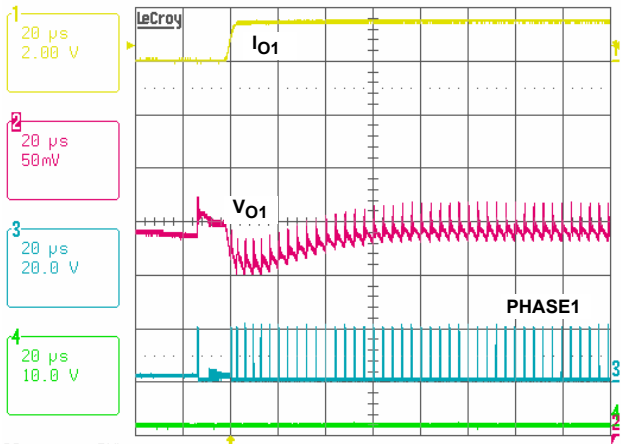

FIGURE 8. LOAD INSERTION RESPONSE, $V_{IN} = 19V$, $V_O = 1.5V$, $I_O = 0.1A/8.1A @ 2.55A/\mu s$

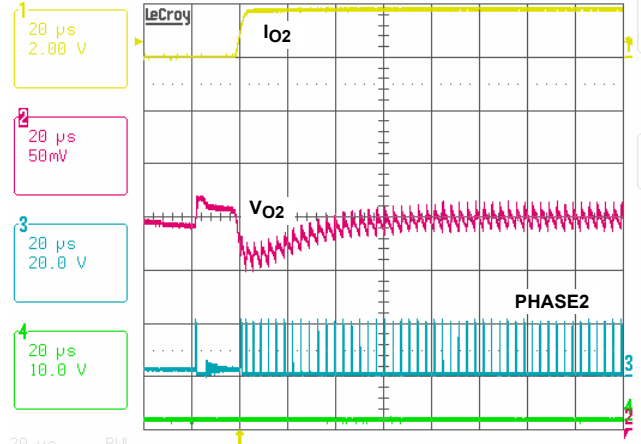

FIGURE 9. LOAD INSERTION RESPONSE, $V_{IN} = 19V$, $V_O = 1.8V$, $I_O = 0.1A/8.1A @ 2.55A/\mu s$

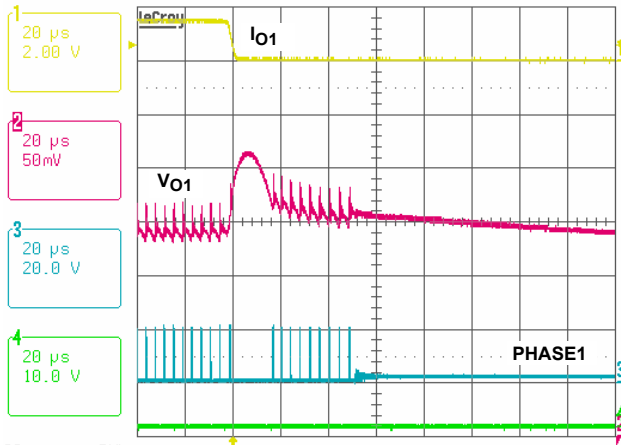

FIGURE 10. LOAD RELEASE RESPONSE, $V_{IN} = 19V$, $V_O = 1.5V$, $I_O = 0.1A/8.1A @ 2.55A/\mu s$

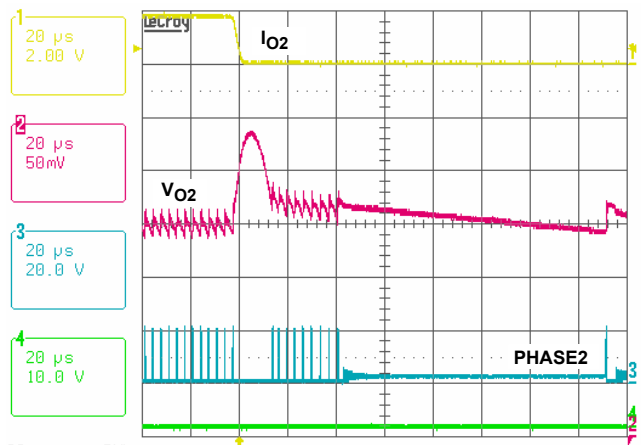

FIGURE 11. LOAD RELEASE RESPONSE, $V_{IN} = 19V$, $V_O = 1.8V$, $I_O = 0.1A/8.1A @ 2.55A/\mu s$

Bill of Materials

QTY	REFERENCE	DESCRIPTION	MANUFACTURER	PART NUMBER
0	DNP (C8, C9)	CAP, RADIAL, 56 μ F, 25V, ROHS	SANYO	25SP56M
2	C1, C3	CAP, SMD, 0603, 1000pF, 16V, 10%, X7R, ROHS	VENKEL	H1045-00102-16V10-T
3	C37, C40, C41	CAP, SMD, 0603, 0.1 μ F, 16V, 10%, X7R, ROHS	MURATA	H1045-00104-16V10-T
6	C2, C7, C30, C31, C36, C39	CAP, SMD, 0603, 1 μ F, 16V, 20%, Y5V, ROHS	MURATA	H1045-00105-16V20-T
2	C18, C19	CAP, SMD, 0603, 10 μ F, 6.3V, 20%, X5R, ROHS	TDK	H1045-00106-6R3V20-T
2	C5, C6	CAP, SMD, 0603, 2200pF, 50V, 10%, X7R, ROHS	MURATA	H1045-00222-50V10-T
2	C20, C21	CAP, SMD, 0603, 0.15 μ F, 16V, 10%, X7R, ROHS	VENKEL	H1045-00154-25V10-T
2	C14, C15	CAP, SMD, 0603, 0.22 μ F, 25V, 10%, X7R, ROHS	TDK	H1045-00224-16V10-T
2	C4, C38	CAP, SMD, 0603, 0.22 μ F, 25V, 20%, X7R, ROHS	VENKEL	H1045-00224-25V20-T
2	C34, C35	CAP, SMD, 0805, 4.7 μ F, 16V, 10%, X5R, ROHS	PANASONIC	H1046-00475-16V10-T
0	DNP (C32, C33)	CAP, SMD, 0805, 4.7 μ F, 16V, 10%, X5R, ROHS	PANASONIC	H1046-00475-16V10-T
2	C16, C17	CAP, SMD, 1206, 1 μ F, 25V, 20%, X5R, ROHS	PANASONIC	H1065-00105-25V20-T
4	C10 to C13	CAP, SMD, 1206, 10 μ F, 25V, 20%, X5R, ROHS	PANASONIC	H1065-00106-25V20-T
2	C27, C29	CAP-LOW ESR,SMD, D3L, 330 μ F, 6.3V, 20%, POSCAP, ROHS	SANYO	6TPF330M9L
2	C22, C24	CAP-LOW ESR,SMD, D3L, 220 μ F, 6.3V, 20%, POSCAP, ROHS	NEC	PSLV0J227M(12)
0	DNP (C23, C25, C26, C28)	CAP-LOW ESR, SMD, D3L, 330 μ F, 6.3V, 20%, POSCAP, ROHS	SANYO	6TPF330M9L
2	J1, J13	CONN-GEN, BIND.POST, INSUL-RED, THMBNUT-GND	JOHNSON COMPONENTS	111-0702-001
2	J2, J14	CONN-GEN, BIND.POST, INSUL-BLK, THMBNUT-GND	JOHNSON COMPONENTS	111-0703-001
0	J3 to J6, J11, J12	CONN-SCOPE PROBE TEST POINT, PCB MNT	TEKTRONIX	131-4353-00
4	TP1, TP2, TP15, TP16	CONN-TURRET, TERMINAL POST, TH, ROHS	KEYSTONE	1514-2
15	TP3 to TP14, TP17 to TP19	CONN-MINI TEST POINT, VERTICAL, WHITE, ROHS	KEYSTONE	5002
0	DNP (D3, D4)	DIODE-SCHOTTKY, SMD, SMB, 2P, 40V, 3A LOW VF, Pb-FREE	DIODES INC.	B340LB-13-F-T
2	D5, D6	DIODE-SCHOTTKY, SMD, SOT23, 3P, 30V, 200mA, DUAL DIODE	FAIRCHILD	BAT54S-T
2	D1, D2	LED, SMD, 4P, OTHER, POLARIZEDRED/GRN	LUMEX	SSL-LXA3025IGC
2	L1, L2	PWR CHOKE COIL, SMD, 13x12.9, 2.2 μ H, 20%, 18A, ROHS	Vishay	IHLP5050FDER2R2M01
2	U2, U3	IC-HI FREQ BRIDGE DRIVER, 8P, SOIC, 100V, ROHS	INTERSIL	HIP2100IBZ
1	U1	IC-DUAL CHANNEL CONTROLLER, 28P, QFN, ROHS	INTERSIL	ISL6228HRZ
5	Q11 to Q14, Q18	TRANSISTOR, N-CHANNEL, 3LD, SOT-23, 60V, 115mA, ROHS	DIODES INC.	2N7002-7-F-T
0	DNP (Q5, Q10)	TRANSISTOR-DUAL N-CHANNEL, 8P, SOIC, 30V, 7.5A, ROHS	FAIRCHILD	FDS6990AS
0	DNP (Q2, Q7)	TRANSISTOR-MOS, N-CHANNEL, 8P, SOIC, 30V, 9.1m Ω RDS, ROHS	INTERNATIONAL RECTIFIER	IRF7821PBF
2	Q1, Q6	TRANSIST-MOS, N-CHANNEL, 8P, SOIC, 30V, 9.1m Ω RDS, ROHS	INTERNATIONAL RECTIFIER	IRF7821PBF

Bill of Materials (Continued)

QTY	REFERENCE	DESCRIPTION	MANUFACTURER	PART NUMBER
0	DNP (Q4, Q9)	TRANSISTOR-MOS, N-CHANNEL, 8P, SOIC, 30V, 4.0mΩ RDS, ROHS	INTERNATIONAL RECTIFIER	IRF7832PBF
2	Q3, Q8	TRANSISTOR-MOS, N-CHANNEL, 8P, SOIC, 30V, 4.0mΩ RDS, ROHS	INTERNATIONAL RECTIFIER	IRF7832PBF
2	Q15, Q16	TRANSISTOR-MOS, N-CHANNEL, SMD, TO-252, 30V, 20A, ROHS	VISHAY	SUD50N03-07-E3
4	R9, R52, R53, R54	RES, SMD, 0603, 2Ω, 1/10W, 1%, TF, ROHS	YAGEO	H2511-00020-1/10W1-T
0	DNP (R12, R13, R57, R58)	RESISTOR, SMD, 0603, 0Ω, 1/10W, TF, ROHS	KOA	H2511-00R00-1/10W-T
10	R10, R11, R24, R25, R48, R50, R55, R56, R59, R60	RESISTOR, SMD, 0603, 0Ω, 1/10W, TF, ROHS	KOA	H2511-00R00-1/10W-T
5	R7, R8, R21, R22, R51	RES, SMD, 0603, 10k, 1/10W, 1%, TF, ROHS	KOA	H2511-01002-1/10W1-T
2	R20, R23	RES, SMD, 0603, 105k, 1/10W, 1%, TF, ROHS	PANASONIC	H2511-01053-1/10W1-T
2	R35, R37	RES, SMD, 0603, 1.62k, 1/10W, 1%, TF, ROHS	PANASONIC	H2511-01621-1/10W1-T
1	R49	RES, SMD, 0603, 210k, 1/10W, 1%, TF, ROHS	YAGEO	H2511-02103-1/10W1-T
2	R26, R27	RES, SMD, 0603, 2k, 1/10W, 1%, TF, ROHS	KOA	H2511-02001-1/10W1-T
1	R3	RES, SMD, 0603, 19.6k, 1/10W, 1%, TF, ROHS	KOA	H2511-01962-1/10W1-T
1	R4	RES, SMD, 0603, 24.3k, 1/10W, 1%, TF, ROHS	PANASONIC	H2511-02432-1/10W1-T
2	R34, R36	RES, SMD, 0603, 4.02k, 1/10W, 1%, TF, ROHS	KOA	H2511-04021-1/10W1-T
1	R14	RES, SMD, 0603, 52.3k, 1/16W, 1%, TF, ROHS	VENKEL	H2511-05232-1/10W1-T
4	R1, R2, R5, R6	RES, SMD, 0603, 499Ω, 1/10W, 1%, TF, ROHS	KOA	H2511-04990-1/10W1-T
2	R30, R31	RES, SMD, 0603, 49.9k, 1/10W, 1%, TF, ROHS	VENKEL	H2511-04992-1/10W1-T
1	R15	RES, SMD, 0603, 69.8k, 1/10W, 1%, TF, ROHS	YAGEO	H2511-06982-1/10W1-T
4	R16, R17, R28, R29	RES, SMD, 0603, 3.83k, 1/10W, 1%, TF, ROHS	ROHM	H2511-03831-1/10W1-T
2	R18, R19	RES, SMD, 0603, 845Ω, 1/10W, 1%, TF, ROHS	VENKEL	H2511-08450-1/10W1-T
2	R20, R23	RES, SMD, 0603, 80.6k, 1/10W, 1%, TF, ROHS	VENKEL	H2511-08062-1/10W1-T
1	R32	RES, SMD, 1206, 1Ω, 1/4W, 1%, TF, ROHS	VENKEL	H2513-001R0-1/4W1-T
9	R38, R40 to R47	RES, SMD, 1206, 1.5Ω, 1/4W, 1%, TF, ROHS	VENKEL	H2513-001R5-1/4W1-T
2	R33, R39	RES, SMD, 1206, 0.75Ω, 1/4W, 1%, TF, ROHS	SUSUMU	RL1632R-R750-F
5	S1 to S5	SWITCH-TOGGLE, SMD, ULTRAMINI, 1P, SPST MINI	C&K COMPONENTS	GT11MSCBE-T
4	J7 to J10	MTG HDWR, CBL.TERMINAL-LUG and SCREW, 6 to 14AWG	BERG/FCI	KPA8CTP

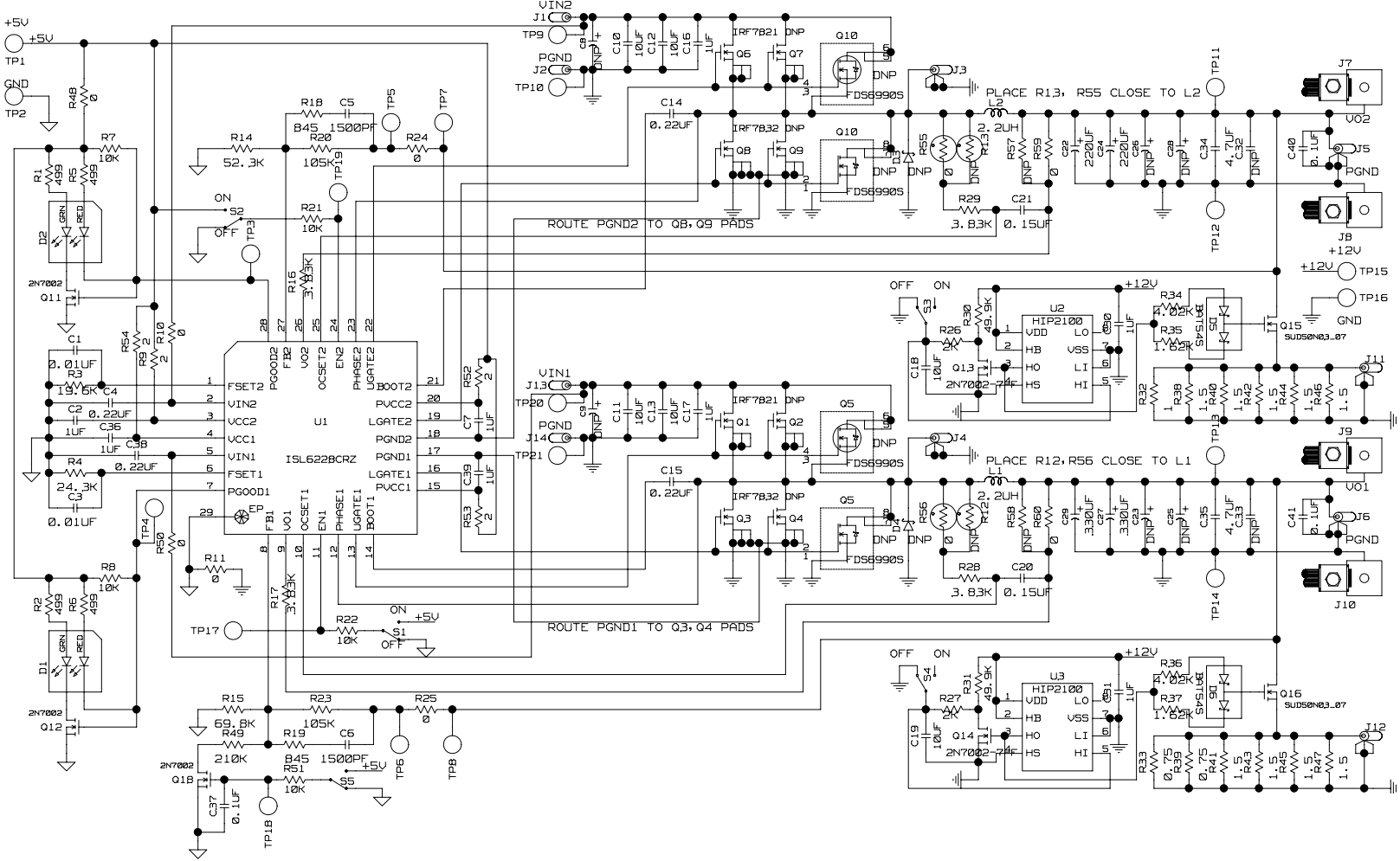

FIGURE 12. ISL6228LOEVAL3Z SCHEMATIC

ISL6228LOEVAL3Z Evaluation Board Schematic

ISL6228LOEVAL3Z Evaluation Board Layout

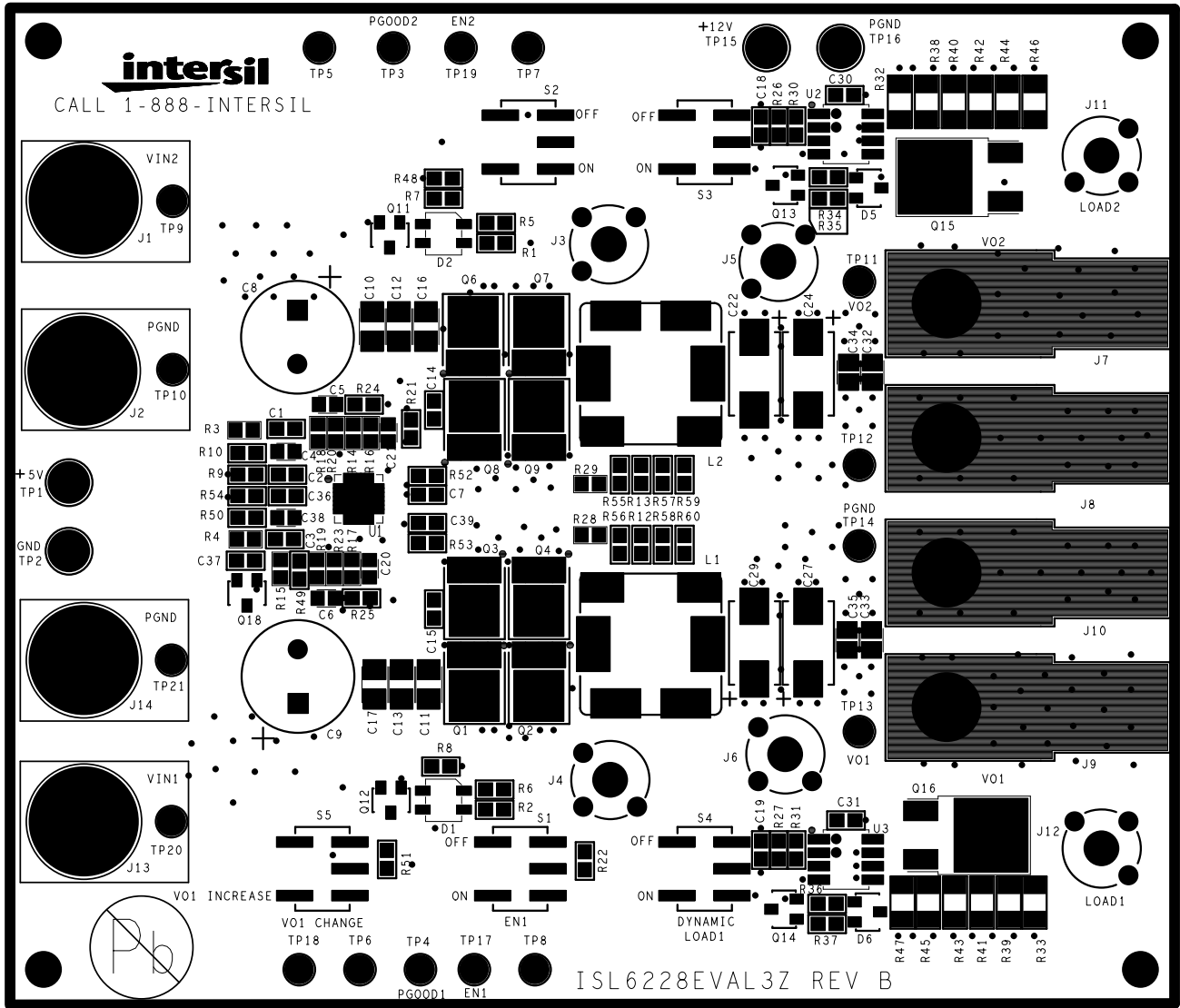

FIGURE 13. TOP SILKSCREEN

ISL6228LOEVAL3Z Evaluation Board Layout (Continued)

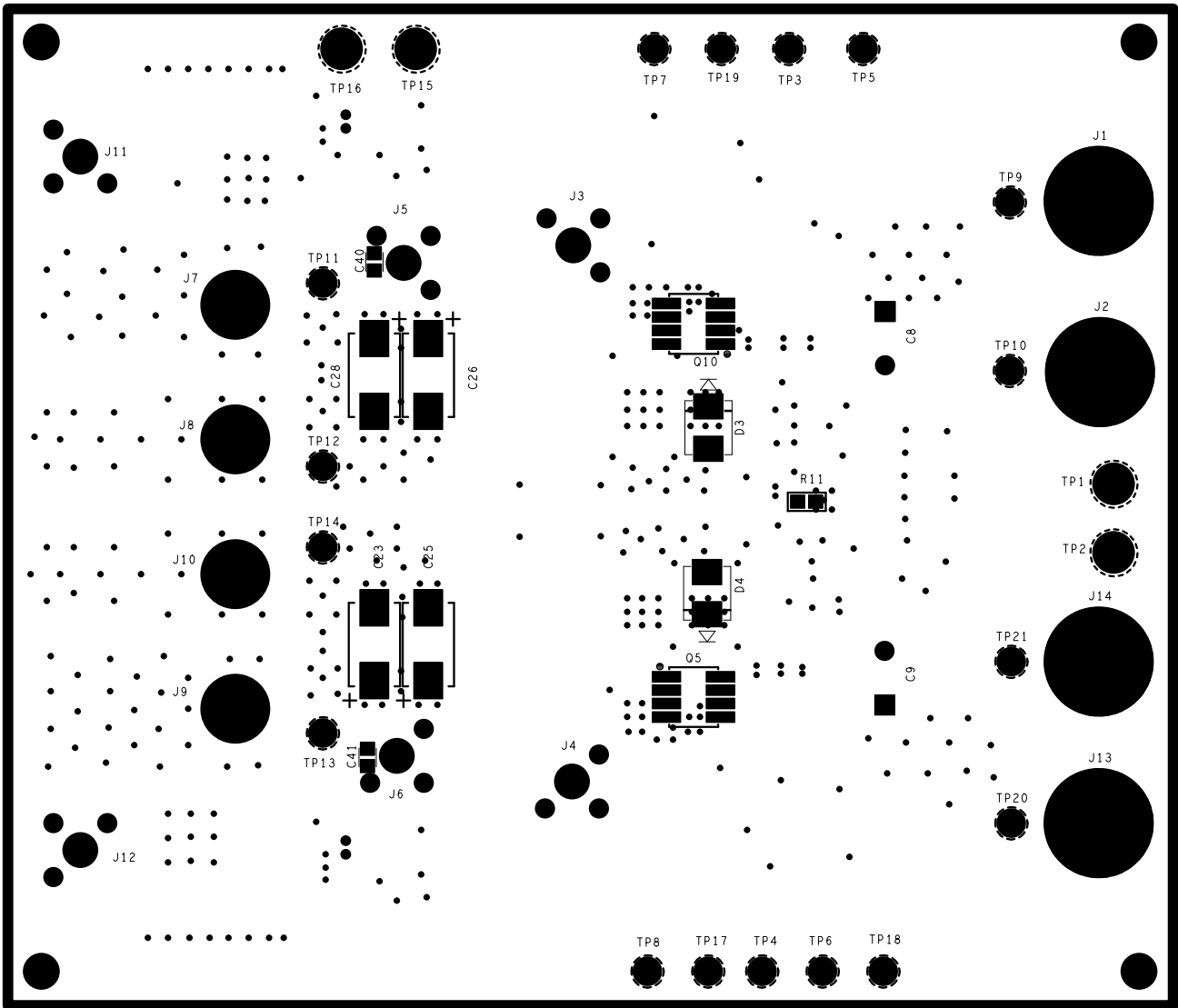

FIGURE 14. BOTTOM SILKSCREEN

ISL6228LOEVAL3Z Evaluation Board Layout (Continued)

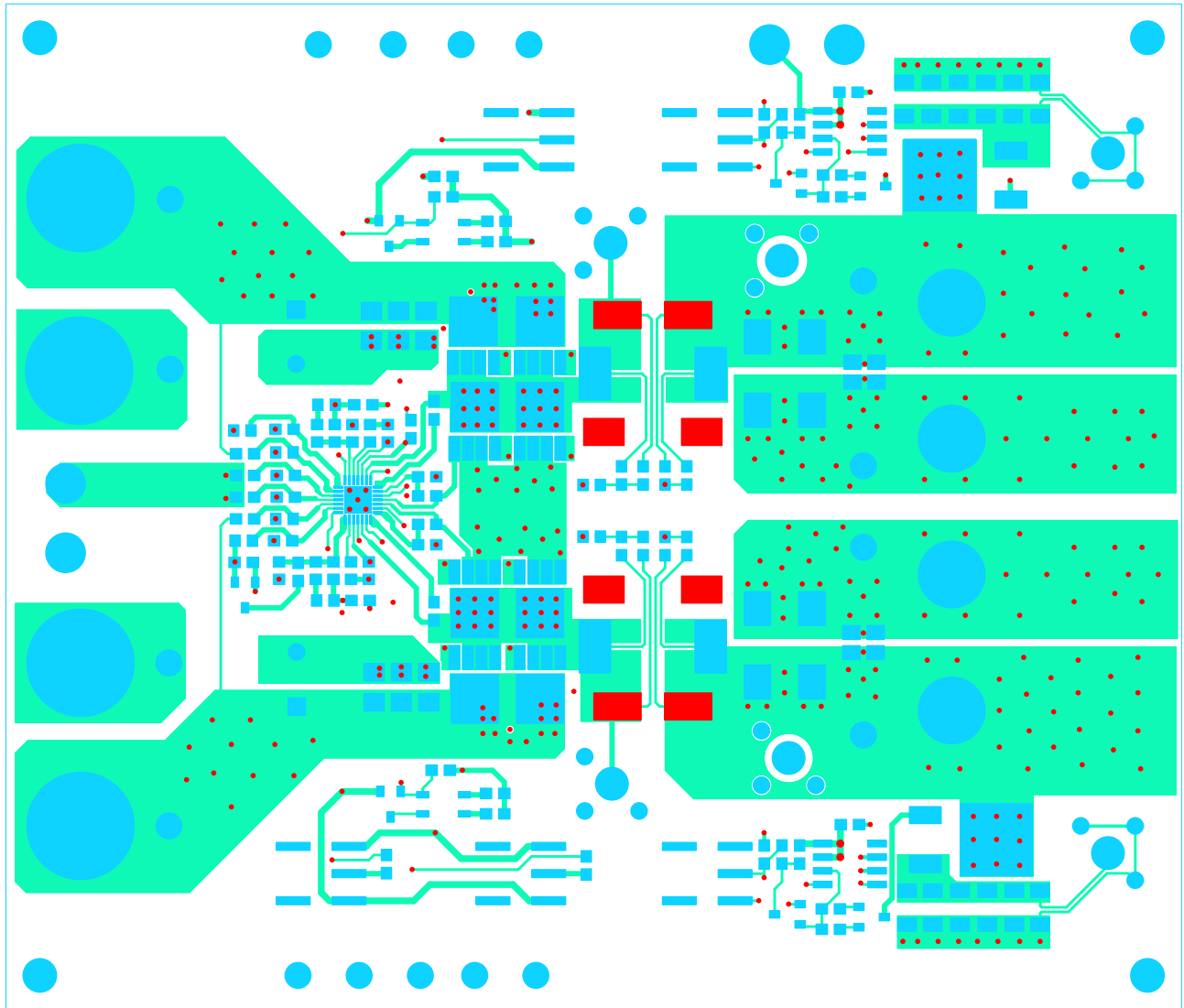

FIGURE 15. LAYER 1

ISL6228LOEVAL3Z Evaluation Board Layout (Continued)

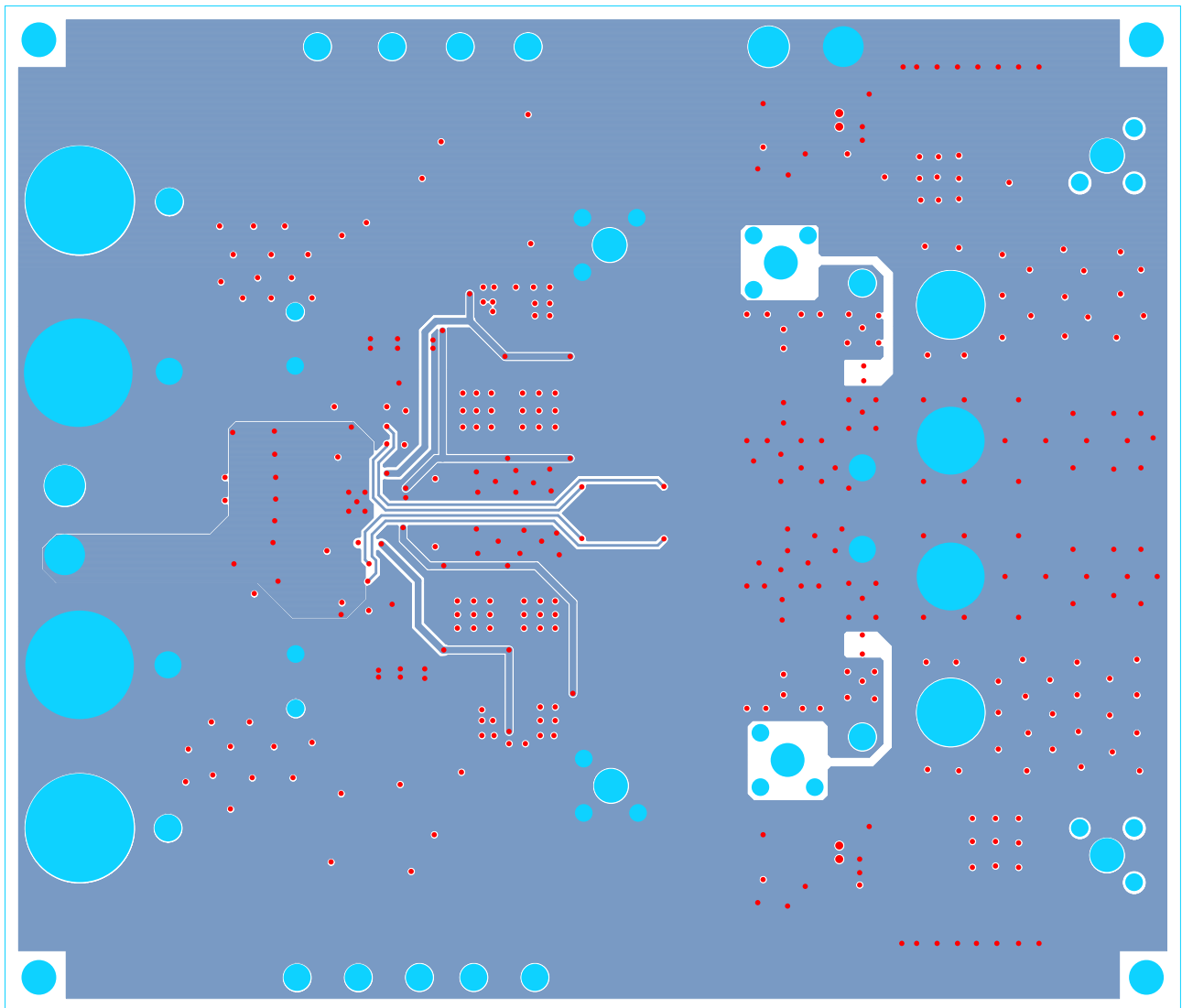

FIGURE 16. LAYER 2

ISL6228LOEVAL3Z Evaluation Board Layout (Continued)

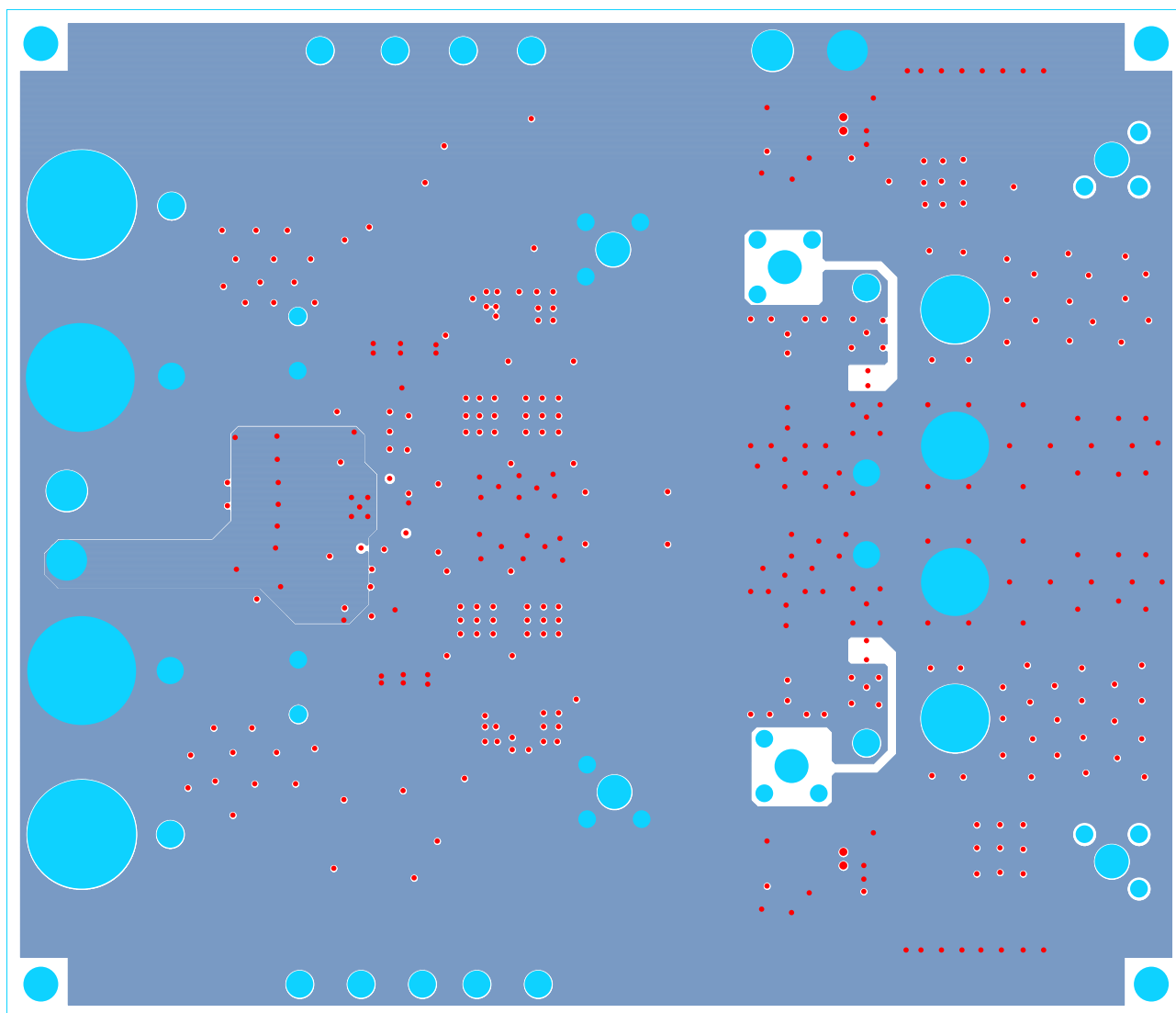

FIGURE 17. LAYER 3

ISL6228LOEVAL3Z Evaluation Board Layout (Continued)

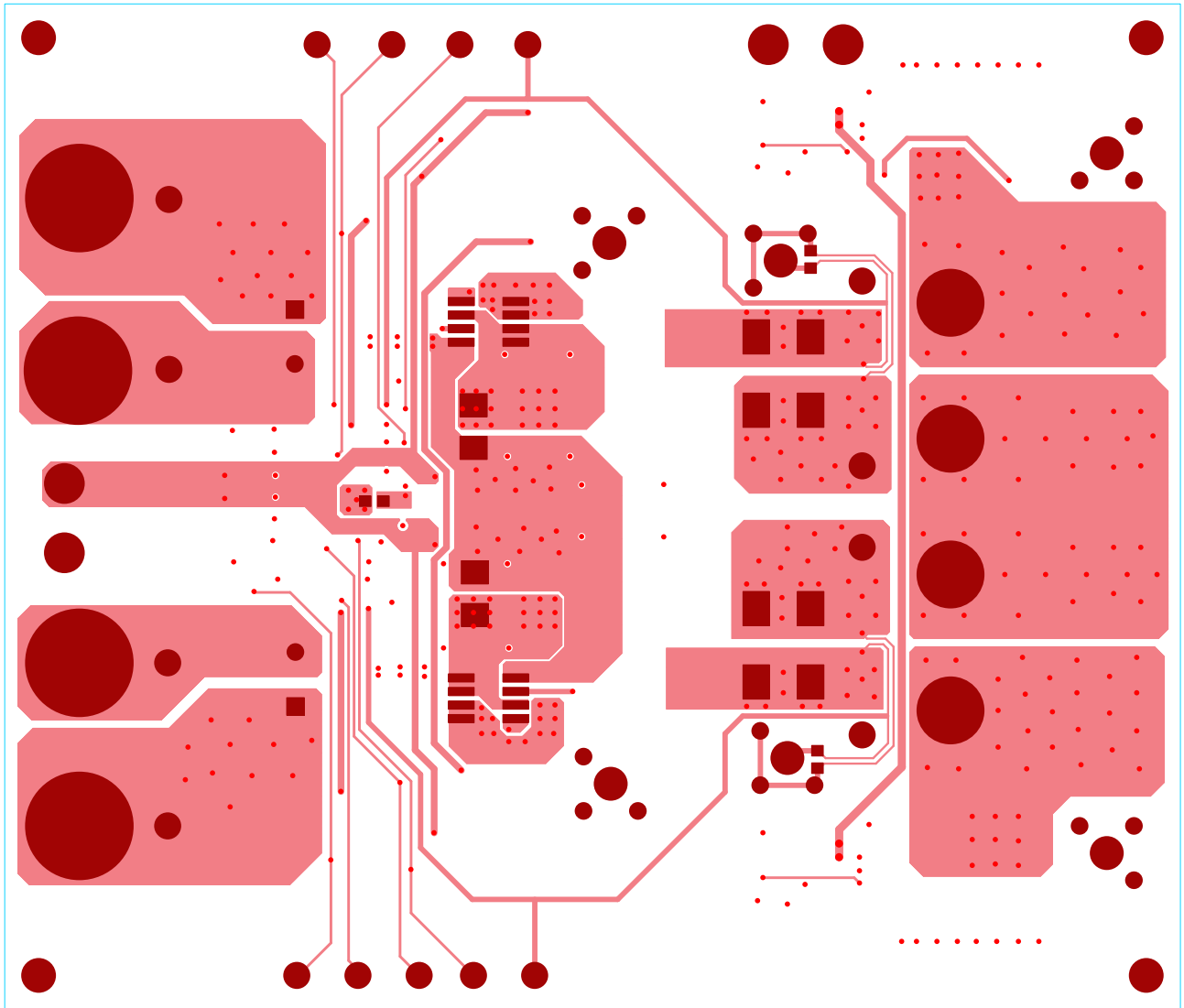

FIGURE 18. LAYER 4

Notice

1. Descriptions of circuits, software and other related information in this document are provided only to illustrate the operation of semiconductor products and application examples. You are fully responsible for the incorporation or any other use of the circuits, software, and information in the design of your product or system. Renesas Electronics disclaims any and all liability for any losses and damages incurred by you or third parties arising from the use of these circuits, software, or information.
2. Renesas Electronics hereby expressly disclaims any warranties against and liability for infringement or any other claims involving patents, copyrights, or other intellectual property rights of third parties, by or arising from the use of Renesas Electronics products or technical information described in this document, including but not limited to, the product data, drawings, charts, programs, algorithms, and application examples.
3. No license, express, implied or otherwise, is granted hereby under any patents, copyrights or other intellectual property rights of Renesas Electronics or others.
4. You shall not alter, modify, copy, or reverse engineer any Renesas Electronics product, whether in whole or in part. Renesas Electronics disclaims any and all liability for any losses or damages incurred by you or third parties arising from such alteration, modification, copying or reverse engineering.
5. Renesas Electronics products are classified according to the following two quality grades: "Standard" and "High Quality". The intended applications for each Renesas Electronics product depends on the product's quality grade, as indicated below.
"Standard": Computers; office equipment; communications equipment; test and measurement equipment; audio and visual equipment; home electronic appliances; machine tools; personal electronic equipment; industrial robots; etc.
"High Quality": Transportation equipment (automobiles, trains, ships, etc.); traffic control (traffic lights); large-scale communication equipment; key financial terminal systems; safety control equipment; etc.
Unless expressly designated as a high reliability product or a product for harsh environments in a Renesas Electronics data sheet or other Renesas Electronics document, Renesas Electronics products are not intended or authorized for use in products or systems that may pose a direct threat to human life or bodily injury (artificial life support devices or systems; surgical implantations; etc.), or may cause serious property damage (space system; undersea repeaters; nuclear power control systems; aircraft control systems; key plant systems; military equipment; etc.). Renesas Electronics disclaims any and all liability for any damages or losses incurred by you or any third parties arising from the use of any Renesas Electronics product that is inconsistent with any Renesas Electronics data sheet, user's manual or other Renesas Electronics document.
6. When using Renesas Electronics products, refer to the latest product information (data sheets, user's manuals, application notes, "General Notes for Handling and Using Semiconductor Devices" in the reliability handbook, etc.), and ensure that usage conditions are within the ranges specified by Renesas Electronics with respect to maximum ratings, operating power supply voltage range, heat dissipation characteristics, installation, etc. Renesas Electronics disclaims any and all liability for any malfunctions, failure or accident arising out of the use of Renesas Electronics products outside of such specified ranges.
7. Although Renesas Electronics endeavors to improve the quality and reliability of Renesas Electronics products, semiconductor products have specific characteristics, such as the occurrence of failure at a certain rate and malfunctions under certain use conditions. Unless designated as a high reliability product or a product for harsh environments in a Renesas Electronics data sheet or other Renesas Electronics document, Renesas Electronics products are not subject to radiation resistance design. You are responsible for implementing safety measures to guard against the possibility of bodily injury, injury or damage caused by fire, and/or danger to the public in the event of a failure or malfunction of Renesas Electronics products, such as safety design for hardware and software, including but not limited to redundancy, fire control and malfunction prevention, appropriate treatment for aging degradation or any other appropriate measures. Because the evaluation of microcomputer software alone is very difficult and impractical, you are responsible for evaluating the safety of the final products or systems manufactured by you.
8. Please contact a Renesas Electronics sales office for details as to environmental matters such as the environmental compatibility of each Renesas Electronics product. You are responsible for carefully and sufficiently investigating applicable laws and regulations that regulate the inclusion or use of controlled substances, including without limitation, the EU RoHS Directive, and using Renesas Electronics products in compliance with all these applicable laws and regulations. Renesas Electronics disclaims any and all liability for damages or losses occurring as a result of your noncompliance with applicable laws and regulations.
9. Renesas Electronics products and technologies shall not be used for or incorporated into any products or systems whose manufacture, use, or sale is prohibited under any applicable domestic or foreign laws or regulations. You shall comply with any applicable export control laws and regulations promulgated and administered by the governments of any countries asserting jurisdiction over the parties or transactions.
10. It is the responsibility of the buyer or distributor of Renesas Electronics products, or any other party who distributes, disposes of, or otherwise sells or transfers the product to a third party, to notify such third party in advance of the contents and conditions set forth in this document.
11. This document shall not be reprinted, reproduced or duplicated in any form, in whole or in part, without prior written consent of Renesas Electronics.
12. Please contact a Renesas Electronics sales office if you have any questions regarding the information contained in this document or Renesas Electronics products.
(Note 1) "Renesas Electronics" as used in this document means Renesas Electronics Corporation and also includes its directly or indirectly controlled subsidiaries.
(Note 2) "Renesas Electronics product(s)" means any product developed or manufactured by or for Renesas Electronics.

(Rev.4.0-1 November 2017)



SALES OFFICES

Renesas Electronics Corporation

<http://www.renesas.com>

Refer to "<http://www.renesas.com/>" for the latest and detailed information.

Renesas Electronics America Inc.
1001 Murphy Ranch Road, Milpitas, CA 95035, U.S.A.
Tel: +1-408-432-8888, Fax: +1-408-434-5351

Renesas Electronics Canada Limited
9251 Yonge Street, Suite 8309 Richmond Hill, Ontario Canada L4C 9T3
Tel: +1-905-237-2004

Renesas Electronics Europe Limited
Dukes Meadow, Millboard Road, Bourne End, Buckinghamshire, SL8 5FH, U.K
Tel: +44-1628-651-700, Fax: +44-1628-651-804

Renesas Electronics Europe GmbH
Arcadiastrasse 10, 40472 Düsseldorf, Germany
Tel: +49-211-6503-0, Fax: +49-211-6503-1327

Renesas Electronics (China) Co., Ltd.
Room 1709 Quantum Plaza, No.27 ZhichunLu, Haidian District, Beijing, 100191 P. R. China
Tel: +86-10-8235-1155, Fax: +86-10-8235-7679

Renesas Electronics (Shanghai) Co., Ltd.
Unit 301, Tower A, Central Towers, 555 Langao Road, Putuo District, Shanghai, 200333 P. R. China
Tel: +86-21-2226-0888, Fax: +86-21-2226-0999

Renesas Electronics Hong Kong Limited
Unit 1601-1611, 16/F., Tower 2, Grand Century Place, 193 Prince Edward Road West, Mongkok, Kowloon, Hong Kong
Tel: +852-2265-6688, Fax: +852-2886-9022

Renesas Electronics Taiwan Co., Ltd.
13F, No. 363, Fu Shing North Road, Taipei 10543, Taiwan
Tel: +886-2-8175-9600, Fax: +886-2-8175-9670

Renesas Electronics Singapore Pte. Ltd.
80 Bendemeer Road, Unit #06-02 Hyflux Innovation Centre, Singapore 339949
Tel: +65-6213-0200, Fax: +65-6213-0300

Renesas Electronics Malaysia Sdn.Bhd.
Unit 1207, Block B, Menara Amcorp, Amcorp Trade Centre, No. 18, Jln Persiaran Barat, 46050 Petaling Jaya, Selangor Darul Ehsan, Malaysia
Tel: +60-3-7955-9390, Fax: +60-3-7955-9510

Renesas Electronics India Pvt. Ltd.
No.777C, 100 Feet Road, HAL 2nd Stage, Indiranagar, Bangalore 560 038, India
Tel: +91-80-67208700, Fax: +91-80-67208777

Renesas Electronics Korea Co., Ltd.
17F, KAMCO Yangjae Tower, 262, Gangnam-daero, Gangnam-gu, Seoul, 06265 Korea
Tel: +82-2-558-3737, Fax: +82-2-558-5338